

31.0 dB, DC-4GHz, 5 Bit Serial Digital Attenuator

Features

- Very Low DC Power Consumption
- Attenuation In Steps From 1 dB To 31 dB
- Single Or Dual Power Supply Voltages
- Serial Data Interface
- 50 Ohm Compatible Impedance
- Space Saving LPCC™ Surface Mount Packaging

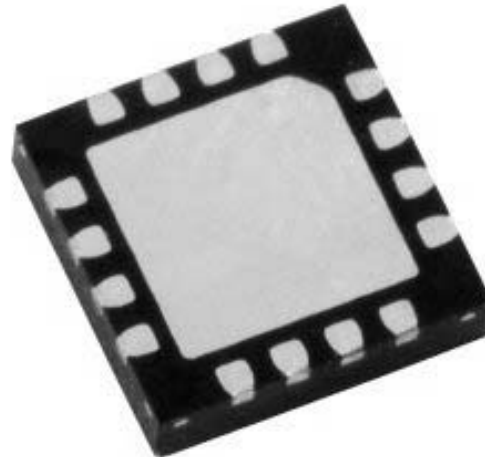

HRF-AT4521 in LPCC™ Package

Product Description

The Honeywell HRF-AT4521 is a 5-bit digital attenuator that is ideal for use in broadband communication system applications that require accuracy, speed and low power consumption. The HRF-AT4521 is manufactured with Honeywell's patented Silicon On Insulator (SOI) CMOS manufacturing technology, which provides the performance of GaAs with the economy and integration capabilities of conventional CMOS.

RF Electrical Specifications @ + 25°C

Parameter	Test Condition	Frequency	Minimum	Typical	Maximum	Units
Insertion Loss		DC – 0.5 GHz		1.8		dB
		2.0 GHz		2.8		dB
		3.0 GHz		--		dB
		4.0 GHz		--		dB
1dB Compression	VSS = 0V, Input Power	DC – 2.0 GHz		24		dBm
1dB Compression	VSS = - VDD, Input Power	DC – 2.0 GHz		29		dBm
Input IP3	VSS = 0V Two-tone inputs Up To +5 dBm @ 0 dBm Attenuation	DC – 2.0 GHz		38		dBm
Input IP3	V _{ss} = - V _{DD} Two-tone inputs Up To + 5 dBm @ 0 dBm Attenuation	DC – 2.0 GHz		>38		dBm
Return Loss*	Any Combination of Bits	DC - 4.0 GHz		11		dB
Attenuation Accuracy	All attenuation states	DC – 1.0 GHz	+/- (0.3 + 3% of programmed IL)			dB
		2.0 GHz	+/- (0.3 + 3% of programmed IL)			dB
		3.0 GHz	+/- (0.4 + 4% of programmed IL)			dB
		4.0 GHz	+/- (0.5 + 6% of programmed IL)			dB
Trise, Tfall* Ton, Toff (Tpd) Transients	10% To 90% 50% Cntl To 90%/10%RF In-Band			TBD		nS nS mV
T clock Period (Tprd)*	T high / T low = ½ minimum clock period		50			nS
T data set up (Tsup)*	Set up to rising edge of clock		5			nS
T data hold (Thld)*	Data hold after rising edge of clock		2			nS
T latch set up (Tlsup)*	Data set up to falling edge of OE		5			nS

0.01uF Decoupling Capacitors Required On Power Supply Rails.

*By design

Web Site: www.mysoiservices.com
Email: mysoiservices@honeywell.com

2002 4521W Published June 2002 Page 1

Honeywell
Solid State Electronics Center
12001 State Highway 55
Plymouth, Minnesota 55441-4799
1-800-323-8295

Functional Schematic

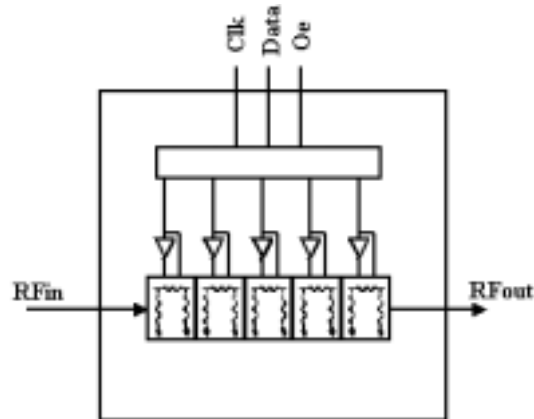

DC Electrical Specifications @ + 25°C

Parameter	Minimum	Typical	Maximum	Units
V_{DD}	3.3 ¹	5.0		V
V_{SS}			-5.0	V
I_{DD} Power Supply Current			2	mA
CMOS Logic level (0)	0		0.8	V
CMOS Logic level (1)	$V_{DD} - 0.8$		V_{DD}	V
Input Leakage Current			10	uA

Note 1, the performance curves are for $V_{DD} = +5.0 \pm 10\%$

Absolute Maximum Ratings²

Parameter	Absolute Maximum	Units
Input Power	+ 35	dBm
V_{DD}	+6.0	V
V_{SS}	-5.5	V
ESD Voltage	400	V
Operating Temperature	-40 To +85	Degrees C
Storage Temperature	-65 To +125	Degrees C
Digital Inputs	$V_{DD} + 0.6$ max to $V_{SS} - 0.6$ min	V

Note 2) Operation of this Device beyond any of these parameters may cause permanent damage.

Latch-Up: Unlike conventional CMOS digital attenuators, Honeywells' HRF-AT4521 is immune to latch-up.

ESD Protection: Although the HRF-AT4521 contains ESD protection circuitry on all digital inputs, conventional precautions should be taken to ensure that the Absolute Maximum Ratings are not exceeded.

Web Site: www.mysoiservices.com
 Email: mysoiservices@honeywell.com

2002 4521W Published June 2002 Page 2

Honeywell
 Solid State Electronics Center
 12001 State Highway 55
 Plymouth, Minnesota 55441-4799
 1-800-323-8295

Package Outline Drawing

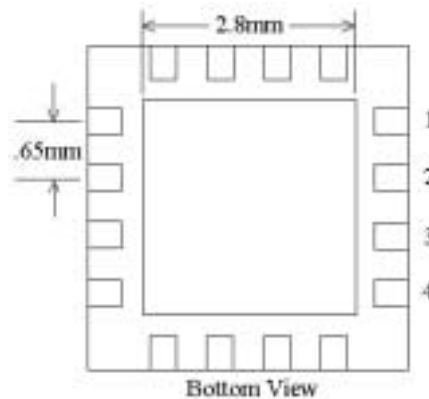

This package conforms to the LPCC[™] 4 x 4 mm 16 lead body dimensions. See ASAT LPCC Marketing Outline Dwg. # DGMJ00004 Latest Rev. at <http://www.asat.com> for additional dimensional information.

Pin Configuration

Pin	Function	Pin	Function
1	VDD	9	GROUND
2	GROUND	10	RF OUTPUT
3	RF INPUT	11	GROUND
4	GROUND	12	VSS
5	GROUND	13	DIGITAL GROUND
6	GROUND	14	OE
7	GROUND	15	CLK
8	GROUND	16	DATA

Serial Data Load

Serial data is shifted into the register on the rising edge of clock, MSB first. The OE falling edge must occur prior to any additional rising clock edges. See the Electrical Spec Table for AC parameters.

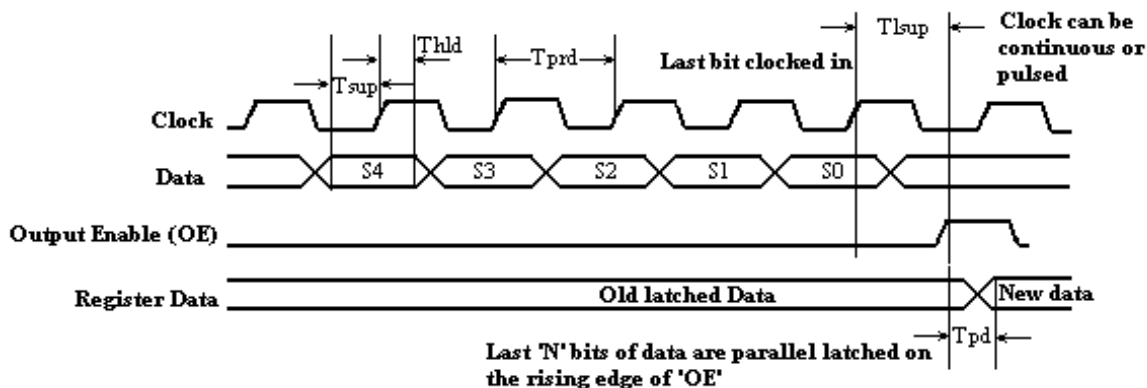

Truth Table

S4	S3	S2	S1	S0	Output
0	0	0	0	0	Reference Input
0	0	0	0	1	1 dB
0	0	0	1	0	2 dB
0	0	1	0	0	4 dB
0	1	0	0	0	8 dB
1	0	0	0	0	16 dB
1	1	1	1	1	31 dB

Evaluation Circuit Board

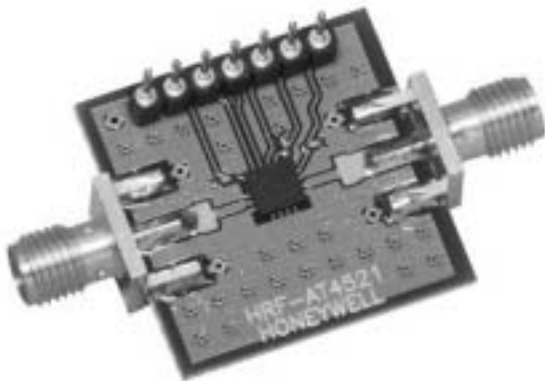

HRF-AT4521 Evaluation Board

Honeywell's evaluation board provides an easy to use method of evaluating the RF performance of our attenuator. Simply connect power, DC and RF signals to be measuring switch performance in less than 10 minutes.

Evaluation Circuit Board Layout Design Details

Item	Description
PCB	Impedance Matched Multi-Layer FR4
Attenuator	HRF-AT4521 Digital Attenuator
Chip Capacitor	Panasonic Model ECU-E1C103KBQ Capacitor, .01uf 0402 10% 16V
RF Connector	Johnson Connectors Model 142-0701-801 SMA RF Coaxial Connector
DC Pin	Mil-Max Model 800-10-064-10-001 Header Pins

Evaluation Circuit Board Connections

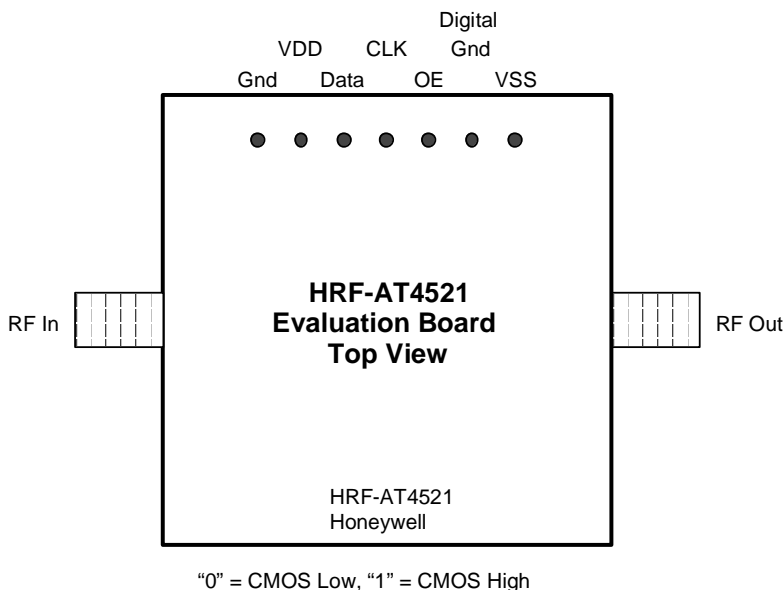

Performance Curves

Insertion Loss

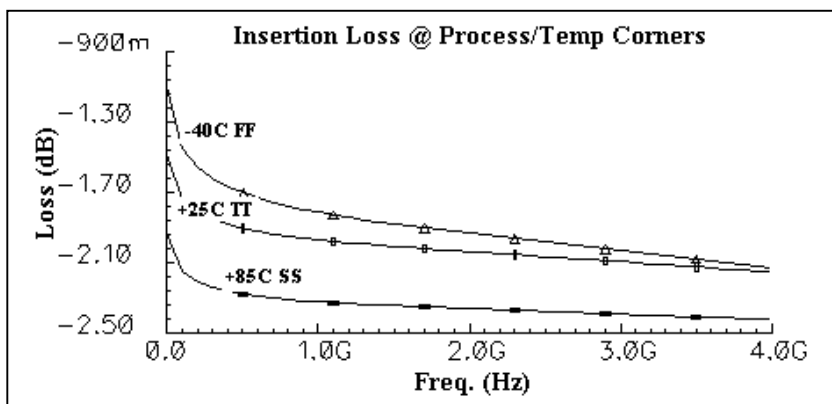

This Insertion Loss curve represents the Min/Max conditions for the "0" pass state versus all processing and temperature conditions. The Min case is at -40C with the "Fast" processing conditions. The Max case is at +85C with the "Slow" processing conditions. All other combinations fall within that band. The typical 25C case is labeled +25C TT.

Return Loss

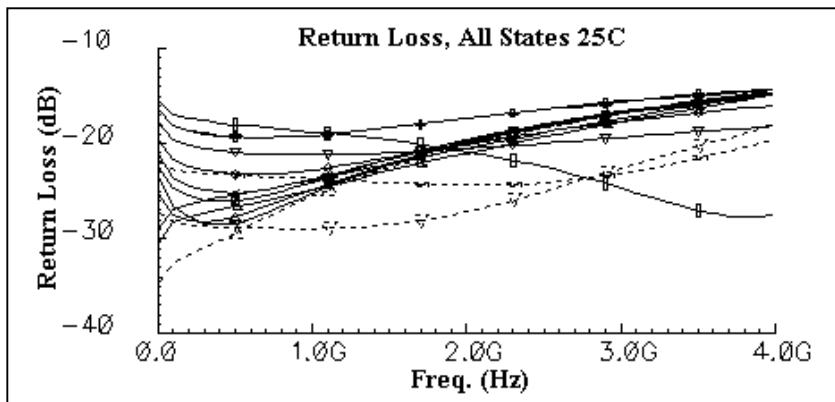

This Return Loss set of curves represents the combination of all Return Loss cases for all attenuation settings. All cases are better than -14dB Return Loss at 4GHz.

Attenuation State Accuracy

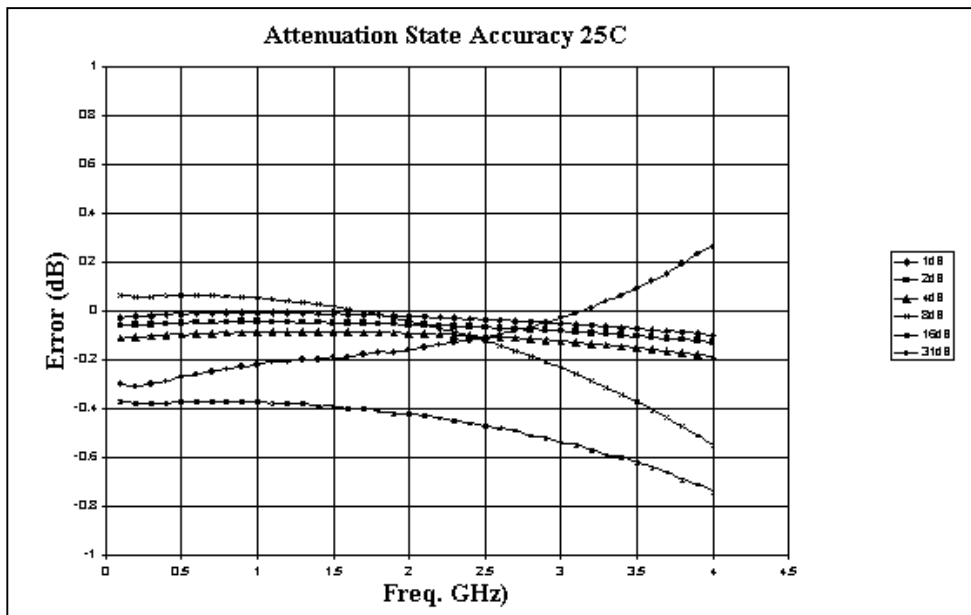

The Attenuation Accuracy curve with vertical axis of $\pm 1\text{dB}$ shows all states better than $\pm 0.5\text{dB}$ to 2GHz and better than $\pm 0.8\text{dB}$ to 4GHz.

Compression

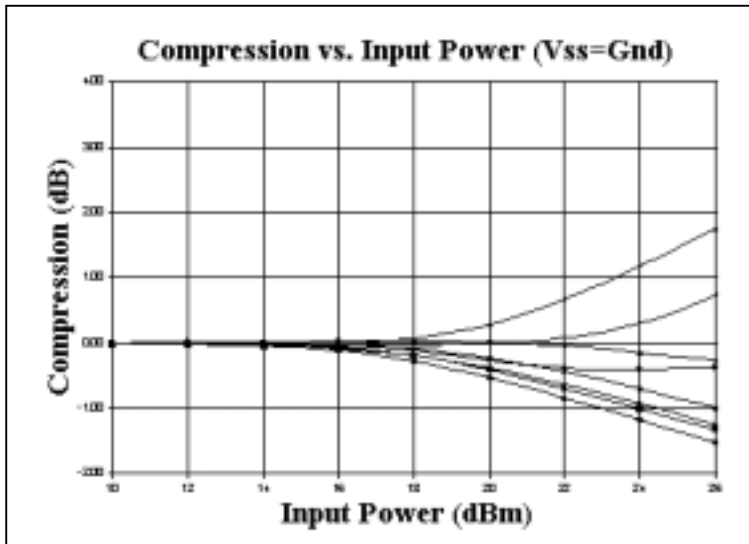

The P1dB curve shows all states with a P1dB compression at approximately 23dB input power. The conditions for this curve are Vdd = +5.0v and Vss = 0v. For higher P1dB compression values, supply Vss with a negative voltage as shown in the next curve.

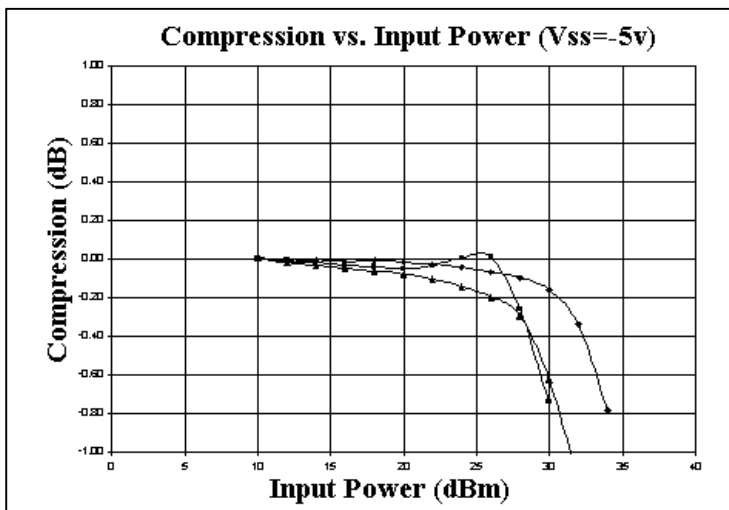

The P1dB curve shows all states with a P1dB compression at approximately 31dB input power. The conditions for this curve are Vdd = +5.0v and Vss = -5.0v.

Ordering Information

Ordering Number	Delivery Method	Units Per Shipment
HRF-AT4521-B	In Chip Tubes	Customer Specific, Usually Minimum Of 50 Per Chip Tube
HRF-AT4521-TR HRF-AT4521-E	On Tape And Reel ³ On Individual Engineering Evaluation Board	Customer Specific One Board Per Box

(Note 3) Call Honeywell for details

LPCC™ is a registered Trademark of ASAT Ltd.

Honeywell reserves the right to make changes to improve reliability, function or design. Honeywell does not assume any liability arising out of the application or use of any product or circuit described herein; neither does it convey any license under its patent rights nor the rights of others.

SUNSTAR 商斯达实业集团是集研发、生产、工程、销售、代理经销、技术咨询、信息服务等为一体的高科技企业，是专业高科技电子产品生产厂家，是具有 10 多年历史的专业电子元器件供应商，是中国最早和最大的仓储式连锁规模经营大型综合电子零部件代理分销商之一，是一家专业代理和分销世界各大品牌 IC 芯片和电子元器件的连锁经营综合性国际公司，专业经营进口、国产名厂名牌电子元件，型号、种类齐全。在香港、北京、深圳、上海、西安、成都等全国主要电子市场设有直属分公司和产品展示展销窗口门市部专卖店及代理分销商，已在全国范围内建成强大统一的供货和代理分销网络。我们专业代理经销、开发生产电子元器件、集成电路、传感器、微波光电元器件、工控机/DOC/DOM 电子盘、专用电路、单片机开发、MCU/DSP/ARM/FPGA 软件硬件、二极管、三极管、模块等，是您可靠的一站式现货配套供应商、方案提供商、部件功能模块开发配套商。商斯达实业公司拥有庞大的资料库，有数位毕业于著名高校——有中国电子工业摇篮之称的西安电子科技大学（西军电）并长期从事国防尖端科技研究的高级工程师为您精挑细选、量身订做各种高科技电子元器件，并解决各种技术问题。

微波光电部专业代理经销高频、微波、光纤、光电元器件、组件、部件、模块、整机；电磁兼容元器件、材料、设备；微波 CAD、EDA 软件、开发测试仿真工具；微波、光纤仪器仪表。欢迎国外高科技微波、光纤厂商将优秀产品介绍到中国、共同开拓市场。长期大量现货专业批发高频、微波、卫星、光纤、电视、CATV 器件：晶振、VCO、连接器、PIN 开关、变容二极管、开关二极管、低噪晶体管、功率电阻及电容、放大器、功率管、MMIC、混频器、耦合器、功分器、振荡器、合成器、衰减器、滤波器、隔离器、环行器、移相器、调制解调器；光电子元件和组件：红外发射管、红外接收管、光电开关、光敏管、发光二极管和发光二极管组件、半导体激光二极管和激光器组件、光电探测器和光接收组件、光发射接收模块、光纤激光器和光放大器、光调制器、光开关、DWDM 用光发射和接收器件、用户接入系统光收发器件与模块、光纤连接器、光纤跳线/尾纤、光衰减器、光纤适配器、光隔离器、光耦合器、光环行器、光复用器/转换器；无线收发芯片和模组、蓝牙芯片和模组。

更多产品请看本公司产品专用销售网站：

商斯达中国传感器科技信息网：<http://www.sensor-ic.com/>

商斯达工控安防网：<http://www.pc-ps.net/>

商斯达电子元器件网：<http://www.sunstare.com/>

商斯达微波光电产品网：[HTTP://www.rfoe.net/](http://www.rfoe.net/)

商斯达消费电子产品网：<http://www.icasic.com/>

商斯达实业科技产品网：<http://www.sunstars.cn/> 微波元器件销售热线：

地址：深圳市福田区福华路福庆街鸿图大厦 1602 室

电话：0755-82884100 83397033 83396822 83398585

传真：0755-83376182 (0) 13823648918 MSN: SUNS8888@hotmail.com

邮编：518033 E-mail:szss20@163.com QQ: 195847376

深圳赛格展销部：深圳华强北路赛格电子市场 2583 号 电话：0755-83665529 25059422

技术支持：0755-83394033 13501568376

欢迎索取免费详细资料、设计指南和光盘；产品凡多，未能尽录，欢迎来电查询。

北京分公司：北京海淀区知春路 132 号中发电子大厦 3097 号

TEL: 010-81159046 82615020 13501189838 FAX: 010-62543996

上海分公司：上海市北京东路 668 号上海赛格电子市场 D125 号

TEL: 021-28311762 56703037 13701955389 FAX: 021-56703037

西安分公司：西安高新开发区 20 所(中国电子科技集团导航技术研究所)

西安劳动南路 88 号电子商城二楼 D23 号

TEL: 029-81022619 13072977981 FAX:029-88789382