

# M155



## Low-Cost Dual-Frequency

This low-cost “blister-type” transducer combines two popular fishfinding frequencies in one housing. Its design is easier and less costly to install than magneto-restrictive transducers requiring steel tanks. The dual-frequency 28 kHz and 200 kHz models offer high and low-frequencies for species specific fishfinding. The single-frequency 38 kHz model features a highly-effective, thirteen-element array that has excellent, deep-water, fishfinding performance.

## Options

- Temperature sensor
- Impedance to customer specifications using matching transformer

## External-Mount 1 - 1.2 kW

### Applications

- Commercial fishing vessels
- Shallow to deep-water fishfinding



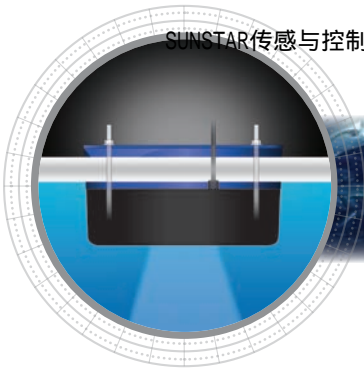

### Features

- Low-ringing, low-sidelobe, 28 kHz array allows fishermen to see bottom structure clearly and to easily discriminate between bottom structure and target fish
- Narrow-beam, low-ringing, 200 kHz ceramic provides clear bottom detail and can detect small bait fish
- Fairing vertically orients sound beams for stronger return echoes resulting in optimal sonar performance
- Stuffing tubes are available to form a watertight conduit for cable routing and are available in a variety of materials to match all hull types
- Can be mounted as an in-hull in a fiberglass hull for precise echosounding—even at speeds over 20 knots (23 MPH)
- Fairing is easy-to-cut and will not swell or rot
- Streamlined shape minimizes drag
- All mounting hardware included
- Seamless, SEALCAST™, urethane housing for long life underwater





## Technical Information

Frequencies	Configuration	Beamwidth (@-3 dB)	RMS Power (W)	FOM (dB)	Q	Series Impedance (R-jX)
28 kHz-G	 A	24° x 37°	1 kW	-20	9	60-j0(t)
28 kHz-G	 B	24° x 37°	1 kW	-17	9	150-j0(t)
38 kHz-D	 C	11° x 21°	1.2 kW	-10	6	70-j0(t)
200 kHz-AWq	 D	6°	1 kW	-15	10	100-j160(t)

### Technical Data—28 kHz-G

TVR in dB re 1μPa/Volt at 1 m

RVR in dB re 1 Volt/μPa

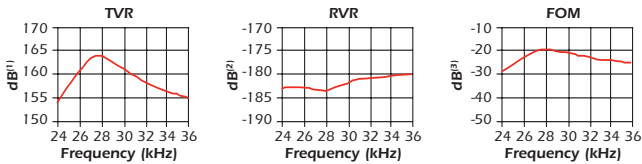

### Directivity Pattern—28 kHz-G

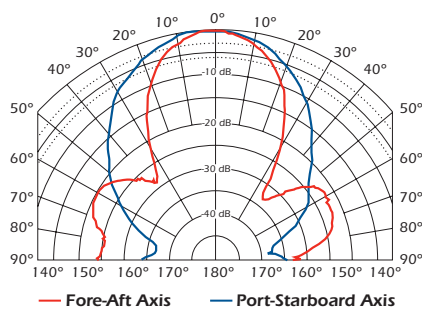

### SPECIFICATIONS

**Weight:** Varies depending on configuration (Call for weight)

**Acoustic Window:** Urethane

**Material Housing:** Cast urethane

### DIMENSIONS

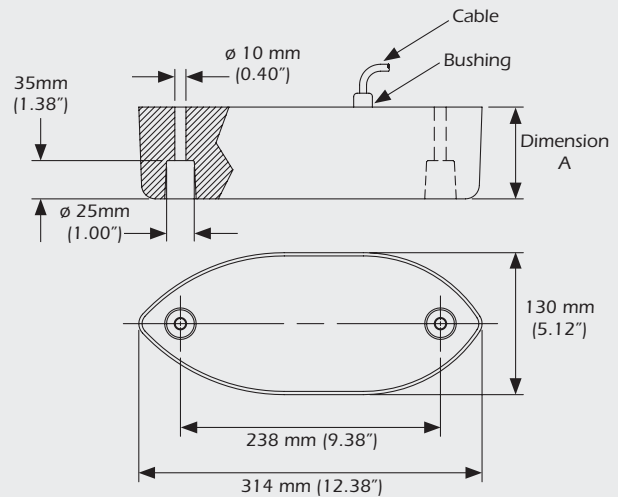

Configuration	Dimension A
C	76 mm (3.00")
A, B, & D	84 mm (3.31")