

EW-612B

Shipped in packet-tape reel(3000pcs/Reel)

EW-612B is composed of a Ultra-high sensitive InSb Hall element and a signal processing IC chip in a package.

Bipolar Hall Effect Latch

Supply Voltage 3~26.4V

Hall Element Continuous Excitation

High Sensitivity Bop:3mT

Output With Pull-up Resistor

SMT

Notice:It is requested to read and accept "IMPORTANT NOTICE" written on the back of the front cover of this catalogue.

Operational Characteristics

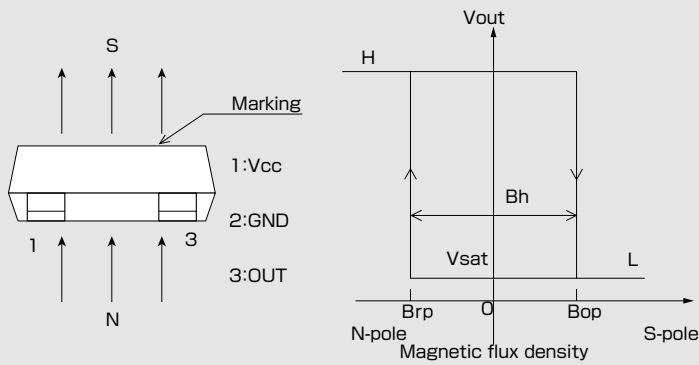

Absolute Maximum Ratings (Ta=25°C)

Item	Symbol	Limit	Unit
Supply Voltage	V_{CC}	26.4 ^(*)	V
Output H Voltage	$V_{O(off)}$	V_{CC}	V
Output L Current	I_{sink}	10	mA
Operating Temperature Range	T_{opr}	-40 ~ 115	°C
Storage Temperature Range	T_{stg}	-40 ~ 125	°C

(*) Please refer to Supply Voltage Derating Curve.

Functional Block Diagram

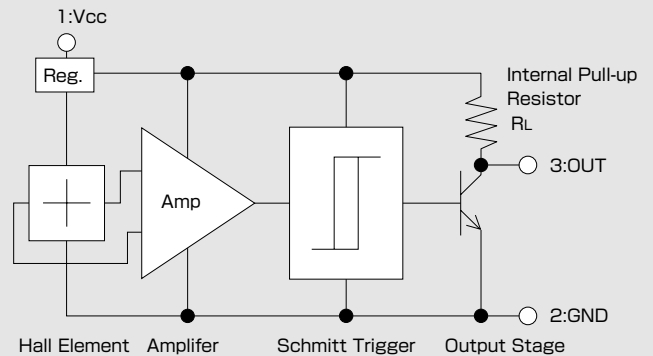

Magnetic and Electrical Characteristics (Ta=25°C)

Item	Symbol	Conditions	Min.	Typ.	Max.	Unit
Supply Voltage	V_{CC}		3	12	26.4	V
Operating Point	B_{OP}	$V_{CC}=12V$	1	3	6	mT
Release Point	B_{rp}	$V_{CC}=12V$	-6	-3	-1	mT
Hysteresis	B_h	$V_{CC}=12V$	2	6		mT
Output Saturation Voltage	V_{sat}	$V_{CC}=12V, OUT="L"$			0.4	V
Supply Current	I_{CC}	$V_{CC}=12V, OUT="H"$		5	6	mA
Output Down Voltage	V_d	$V_{CC}=12V, OUT="H"$			20	mV
Internal Load Resistance	R_L		7	10	13	kΩ

1 [mT]=10 [Gauss]

•Please be aware that our products are not intended for use in life support equipment, devices, or systems. Use of our products in such applications requires the advance written approval of our sales staff.
 Certain applications using semiconductor devices may involve potential risks of personal injury, property damage, or loss of life. In order to minimize these risks, adequate design and operating safeguards should be provided by the customer to minimize inherent or procedural hazards. Inclusion of our products in such applications is understood to be fully at the risk of the customer using our devices or systems.

●Package (Unit:mm)

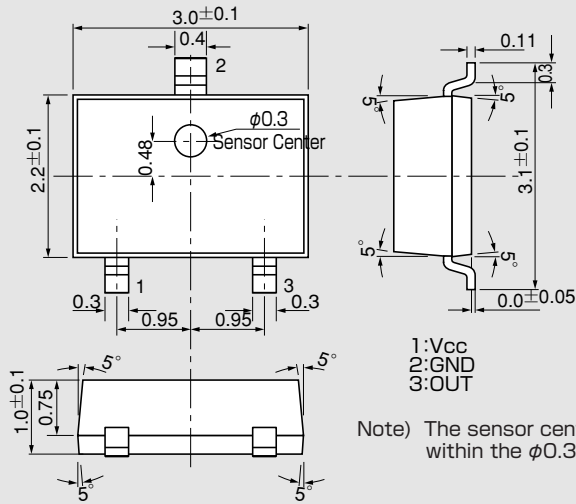

●(For reference only)Land Pattern (Unit:mm)

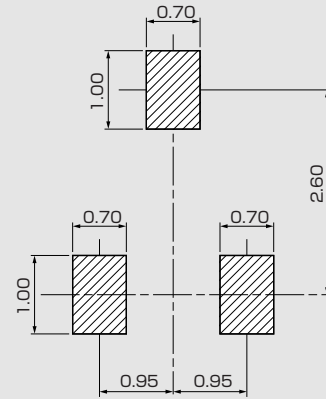

●Supply Voltage

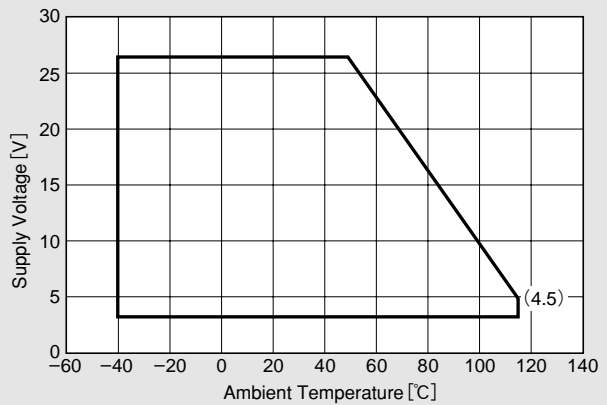

●Temperature Dependence of Bop, Brp

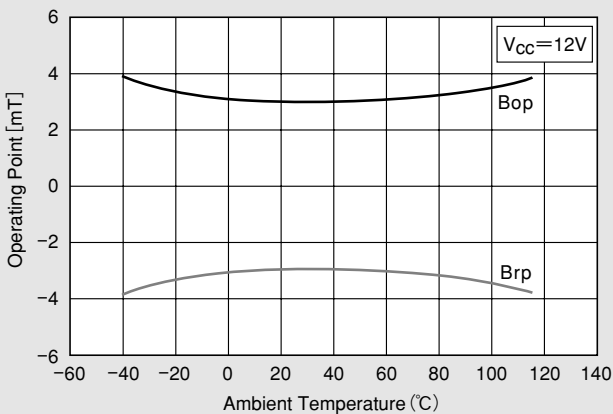

●Supply Voltage Dependence of Bop, Brp

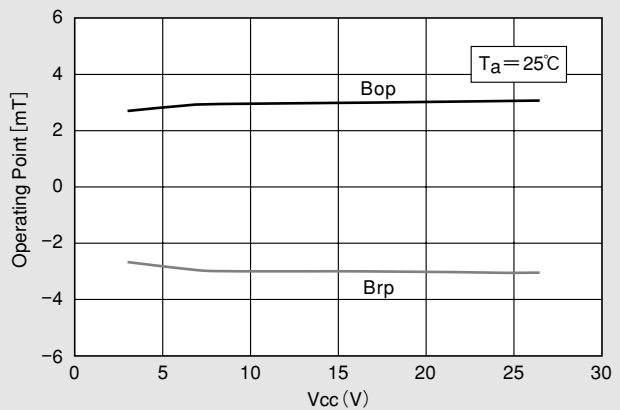

IMPORTANT NOTICE

- These products and their specifications are subject to change without notice. When you consider any use or application of these products, please make inquiries the sales office of Asahi Kasei Microdevices Corporation (AKM) or authorized distributors as to current status of the products.
- Descriptions of external circuits, application circuits, software and other related information contained in this document are provided only to illustrate the operation and application examples of the semiconductor products. You are fully responsible for the incorporation of these external circuits, application circuits, software and other related information in the design of your equipments. AKM assumes no responsibility for any losses incurred by you or third parties arising from the use of these information herein. AKM assumes no liability for infringement of any patent, intellectual property, or other rights in the application or use of such information contained herein.
- Any export of these products, or devices or systems containing them, may require an export license or other official approval under the law and regulations of the country of export pertaining to customs and tariffs, currency exchange, or strategic materials.
- AKM products are neither intended nor authorized for use as critical components^{Note1)} in any safety, life support, or other hazard related device or system^{Note2)}, and AKM assumes no responsibility for such use, except for the use approved with the express written consent by Representative Director of AKM. As used here:
 - Note1) A critical component is one whose failure to function or perform may reasonably be expected to result, whether directly or indirectly, in the loss of the safety or effectiveness of the device or system containing it, and which must therefore meet very high standards of performance and reliability.
 - Note2) A hazard related device or system is one designed or intended for life support or maintenance of safety or for applications in medicine, aerospace, nuclear energy, or other fields, in which its failure to function or perform may reasonably be expected to result in loss of life or in significant injury or damage to person or property.
- It is the responsibility of the buyer or distributor of AKM products, who distributes, disposes of, or otherwise places the product with a third party, to notify such third party in advance of the above content and conditions, and the buyer or distributor agrees to assume any and all responsibility and liability for and hold AKM harmless from any and all claims arising from the use of said product in the absence of such notification.

June 2, 2010

SUNSTAR实业集团是集研发、生产、工程、销售、代理经销、技术咨询、信息服务等为一体的高科技企业，是专业高科技电子产品生产厂家，是具有10多年历史的专业电子元器件供应商，是中国最早和最大的仓储式连锁规模经营大型综合电子零部件代理分销商之一，是一家专业代理和分销世界各大品牌IC芯片和电子元器件的连锁经营综合性国际公司。在香港、北京、深圳、上海、西安、成都等全国主要电子市场设有直属分公司和产品展示展销窗口门市部专卖店及代理分销商，已在全国范围内建成强大统一的供货和代理分销网络。我们专业代理经销、开发生产电子元器件、集成电路、传感器、微波光电元器件、工控机/DOC/DOM电子盘、专用电路、单片机开发、MCU/DSP/ARM/FPGA软件硬件、二极管、三极管、模块等，是您可靠的一站式现货配套供应商、方案提供商、部件功能模块开发配套商。专业以现代信息产业（计算机、通讯及传感器）三大支柱之一的传感器为主营业务，专业经营各类传感器的代理、销售生产、网络信息、科技图书资料及配套产品设计、工程开发。我们的专业网站——**中国传感器科技信息网（全球传感器数据库）www.SENSOR-IC.COM** 服务于全球高科技生产商及贸易商，为企业科技产品开发提供技术交流平台。欢迎各厂商互通有无、交换信息、交换链接、发布寻求代理信息。欢迎国外高科技传感器、变送器、执行器、自动控制产品厂商介绍产品到**中国**，共同开拓市场。本网站是关于各种传感器-变送器-仪器仪表及工业自动化大型专业网站，深入到工业控制、系统工程计 测计量、自动化、安防报警、消费电子等众多领域，把最新的传感器-变送器-仪器仪表买卖信息，最新技术供求，最新采购商，行业动态，发展方向，最新的技术应用和市场资讯及时的传递给广大科技开发、科学研究、产品设计人员。本网站已成功为石油、化工、电力、医药、生物、航空、航天、国防、能源、冶金、电子、工业、农业、交通、汽车、矿山、煤炭、纺织、信息、通信、IT、安防、环保、印刷、科研、气象、仪器仪表等领域从事科学研究、产品设计、开发、生产制造的科技人员、管理人员、和采购人员提供满意服务。 **我公司专业生产、代理、经销、销售各种传感器、变送器、敏感元器件、开关、执行器、仪器仪表、自动化控制系统：专门从事设计、生产、销售各种传感器、变送器、各种测控仪表、热工仪表、现场控制器、计算机控制系统、数据采集系统、各类环境监控系统、专用控制系统应用软件以及嵌入式系统开发及应用等工作。如热敏电阻、压敏电阻、温度传感器、温度变送器、湿度传感器、湿度变送器、气体传感器、气体变送器、压力传感器、压力变送、称重传感器、物（液）位传感器、物（液）位变送器、流量传感器、流量变送器、电流（压）传感器、溶氧传感器、霍尔传感器、图像传感器、超声波传感器、位移传感器、速度传感器、加速度传感器、扭距传感器、红外传感器、紫外传感器、火焰传感器、激光传感器、振动传感器、轴角传感器、光电传感器、接近传感器、干簧管传感器、继电器传感器、微型电泵、磁敏（阻）传感器、压力开关、接近开关、光电开关、色标传感器、光纤传感器、齿轮测速传感器、时间继电器、计数器、计米器、温控仪、固态继电器、调压模块、电磁铁、电压表、电流表等特殊传感器。同时承接传感器应用电路、产品设计和自动化工程项目。**

欢迎索取免费详细资料、设计指南和光盘；产品凡多，未能尽录，欢迎来电查询。

更多产品请看本公司产品专用销售网站：

中国传感器科技信息网：<http://www.sensor-ic.com/>工控安防网：<http://www.pc-ps.net/>

电子元器件网：<http://www.sunstare.com/>微波光电产品网：[HTTP://www.rfoe.net/](http://www.rfoe.net/)

消费电子产品网：<http://www.icasic.com/>军工产品网：<http://www.junpinic.com/>

实业科技产品网：<http://www.sunstars.cn/>传感器销售热线：

电话：0755-83607652 83376489 83376549 83370250 83370251

传真：0755-83376182 (0) 13902971329 MSN: SUNS8888@hotmail.com

邮编：518033 E-mail: szss20@163.com QQ: 195847376

技术支持：0755-83394033 13501568376