

GP1A05E

OPIC Photointerrupter with Connector

■ Features

1. 3-pin connector terminal
2. High sensing accuracy (Slit width : 0.5mm)
3. Wide gap between light emitter and detector (5mm)

■ Applications

1. Copiers
2. Printers
3. Facsimiles

■ Absolute Maximum Ratings (Ta=25°C)

Parameter	Symbol	Rating	Unit
Supply voltage	V _{CC}	-0.5 to +8	V
*1 Low level output current	I _{OL}	50	mA
*2 Operating temperature	T _{opr}	-20 to +75	°C
*2 Storage temperature	T _{stg}	-40 to +85	°C

*1 Collector current of output transistor

*2 The connector should be plugged in/out at normal temperature.

■ Outline Dimensions

(Unit : mm)

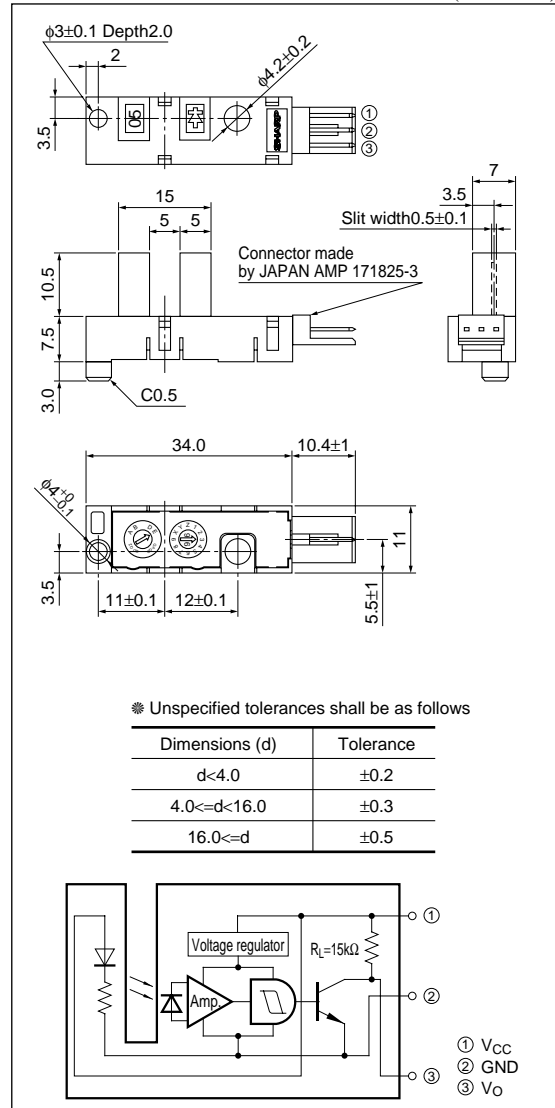

* "OPIC" (Optical IC) is a trademark of the SHARP Corporation.

An OPIC consists of a light-detecting element and signal-processing circuit integrated onto a single chip.

■ Electro-optical Characteristics

($V_{CC}=5V, T_a=25^{\circ}C$)

Parameter	Symbol	Conditions	MIN.	TYP.	MAX.	Unit
Operating supply voltage	V_{CC}		4.5	—	5.5	V
Low level supply current	I_{CCL}	Light beam uninterrupted	—	—	30	mA
Low level output voltage	V_{OL}	Light beam uninterrupted, $I_{OL}=16mA$	—	—	0.35	V
High level supply current	I_{CCH}	Light beam interrupted	—	—	30	mA
High level output voltage	V_{OH}	Light beam interrupted	$V_{CC} \times 0.9$	—	—	V
*3 Response frequency	f	*4	—	—	3 000	Hz

*3 Refer to Fig.1

*4 No DC output is allowed.

Fig.1 Response Frequency

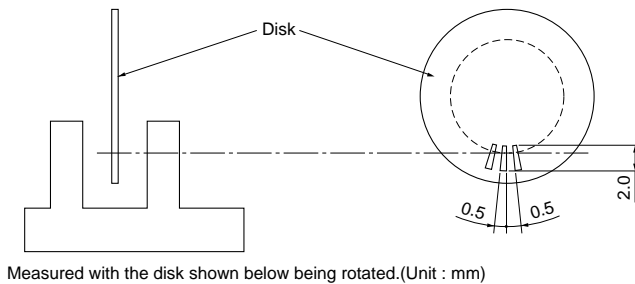

Fig.2 Low Level Output Current vs. Ambient Temperature

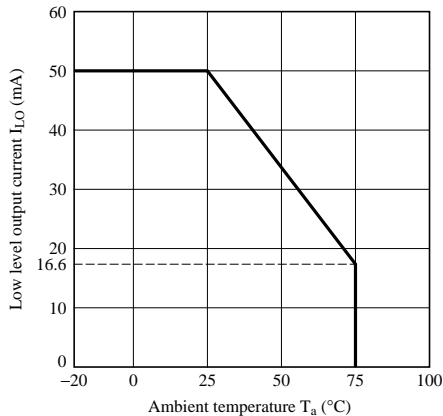

Fig.3 Low Level Output Voltage vs. Low Level Output Current

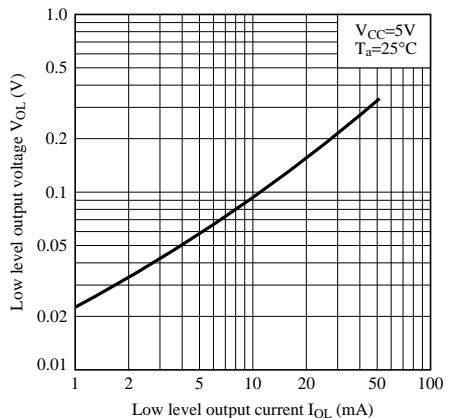

Fig.4 Low Level Output Voltage vs. Ambient Temperature

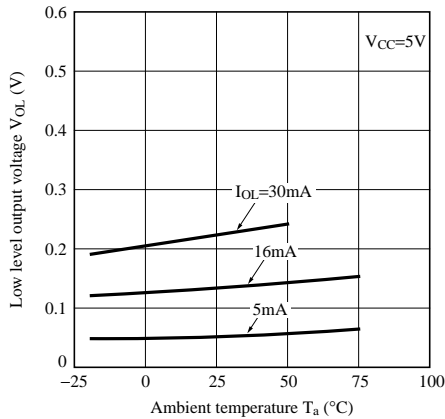

Fig.5 Supply Current vs. Supply Voltage

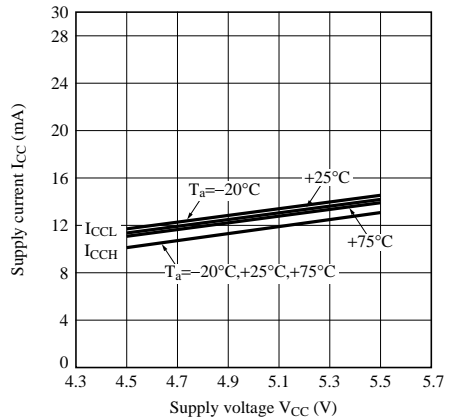

Fig.6 Detecting Position Characteristics (1)

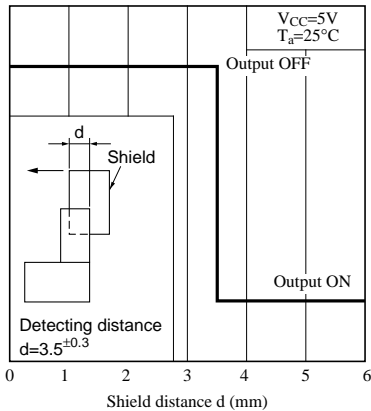
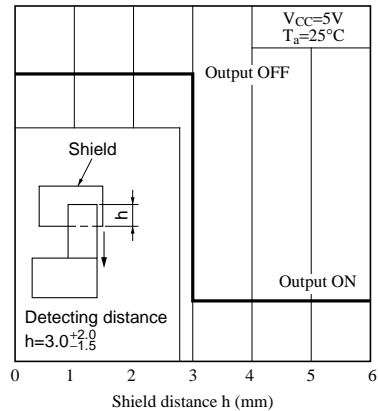

Fig.7 Detecting Position Characteristics (2)



Recommended Connectors on the Inserted Side

Recommended connectors on the inserted side for GP1A05E is same as GP1A05's and GP1A05A's.

Precautions for Use

- It is recommended that a by-pass capacitor of more than 0.01 μ F be added between V_{CC} and GND near the device in order to stabilize power supply line.
- Please don't carry out immersion cleaning or ultrasonic cleaning to avoid keeping solvent inside case of this device.
- Remove dust or stains, using an air blower or a soft cloth moistened in cleaning solvent.
However, do not perform the above cleaning using a soft cloth with cleaning solvent in the marking portion.
In this case, use only the following type of cleaning solvent used for wiping off :
Ethyl alcohol, Methyl alcohol, Isopropyl alcohol,
When the cleaning solvents except for specified materials are used, please consult us.
- As for other general cautions, refer to the chapter "Precautions for Use."

NOTICE

- The circuit application examples in this publication are provided to explain representative applications of SHARP devices and are not intended to guarantee any circuit design or license any intellectual property rights. SHARP takes no responsibility for any problems related to any intellectual property right of a third party resulting from the use of SHARP's devices.
- Contact SHARP in order to obtain the latest device specification sheets before using any SHARP device. SHARP reserves the right to make changes in the specifications, characteristics, data, materials, structure, and other contents described herein at any time without notice in order to improve design or reliability. Manufacturing locations are also subject to change without notice.
- Observe the following points when using any devices in this publication. SHARP takes no responsibility for damage caused by improper use of the devices which does not meet the conditions and absolute maximum ratings to be used specified in the relevant specification sheet nor meet the following conditions:
 - (i) The devices in this publication are designed for use in general electronic equipment designs such as:
 - Personal computers
 - Office automation equipment
 - Telecommunication equipment [terminal]
 - Test and measurement equipment
 - Industrial control
 - Audio visual equipment
 - Consumer electronics
 - (ii) Measures such as fail-safe function and redundant design should be taken to ensure reliability and safety when SHARP devices are used for or in connection with equipment that requires higher reliability such as:
 - Transportation control and safety equipment (i.e., aircraft, trains, automobiles, etc.)
 - Traffic signals
 - Gas leakage sensor breakers
 - Alarm equipment
 - Various safety devices, etc.
 - (iii) SHARP devices shall not be used for or in connection with equipment that requires an extremely high level of reliability and safety such as:
 - Space applications
 - Telecommunication equipment [trunk lines]
 - Nuclear power control equipment
 - Medical and other life support equipment (e.g., scuba).
- Contact a SHARP representative in advance when intending to use SHARP devices for any "specific" applications other than those recommended by SHARP or when it is unclear which category mentioned above controls the intended use.
- If the SHARP devices listed in this publication fall within the scope of strategic products described in the Foreign Exchange and Foreign Trade Control Law of Japan, it is necessary to obtain approval to export such SHARP devices.
- This publication is the proprietary product of SHARP and is copyrighted, with all rights reserved. Under the copyright laws, no part of this publication may be reproduced or transmitted in any form or by any means, electronic or mechanical, for any purpose, in whole or in part, without the express written permission of SHARP. Express written permission is also required before any use of this publication may be made by a third party.
- Contact and consult with a SHARP representative if there are any questions about the contents of this publication.

SUNSTAR实业集团是集研发、生产、工程、销售、代理经销、技术咨询、信息服务等为一体的高科技企业，是专业高科技电子产品生产厂家，是具有 10 多年历史的专业电子元器件供应商，是中国最早和最大的仓储式连锁规模经营大型综合电子零部件代理分销商之一，是一家专业代理和分销世界各大品牌IC芯片和电子元器件的连锁经营综合性国际公司。在香港、北京、深圳、上海、西安、成都等全国主要电子市场设有直属分公司和产品展示展销窗口门市部专卖店及代理分销商，已在全国范围内建成强大统一的供货和代理分销网络。我们专业代理经销、开发生产电子元器件、集成电路、传感器、微波光电元器件、工控机/DOC/DOM电子盘、专用电路、单片机开发、MCU/DSP/ARM/FPGA软件硬件、二极管、三极管、模块等，是您可靠的一站式现货配套供应商、方案提供商、部件功能模块开发配套商。专业以现代信息产业（计算机、通讯及传感器）三大支柱之一的传感器为主营业务，专业经营各类传感器的代理、销售生产、网络信息、科技图书资料及配套产品设计、工程开发。我们的专业网站——**中国传感器科技信息网（全球传感器数据库）www.SENSOR-IC.COM** 服务于全球高科技生产商及贸易商，为企业科技产品开发提供技术交流平台。欢迎各厂商互通有无、交换信息、交换链接、发布寻求代理信息。欢迎国外高科技传感器、变送器、执行器、自动控制产品厂商介绍产品到 中国，共同开拓市场。本网站是关于各种传感器-变送器-仪器仪表及工业自动化大型专业网站，深入到工业控制、系统工程计 测计量、自动化、安防报警、消费电子等众多领域，把最新的传感器-变送器-仪器仪表买卖信息，最新技术供求，最新采购商，行业动态，发展方向，最新的技术应用和市场资讯及时的传递给广大科技开发、科学研究、产品设计人员。本网站已成功为石油、化工、电力、医药、生物、航空、航天、国防、能源、冶金、电子、工业、农业、交通、汽车、矿山、煤炭、纺织、信息、通信、IT、安防、环保、印刷、科研、气象、仪器仪表等领域从事科学研究、产品设计、开发、生产制造的科技人员、管理人员、和采购人员提供满意服务。 **我公司专业生产、代理、经销、销售各种传感器、变送器、敏感元器件、开关、执行器、仪器仪表、自动化控制系统：专门从事设计、生产、销售各种传感器、变送器、各种测控仪表、热工仪表、现场控制器、计算机控制系统、数据采集系统、各类环境监控系统、专用控制系统应用软件以及嵌入式系统开发及应用等工作。如热敏电阻、压敏电阻、温度传感器、温度变送器、湿度传感器、湿度变送器、气体传感器、气体变送器、压力传感器、压力变送、称重传感器、物（液）位传感器、物（液）位变送器、流量传感器、流量变送器、电流（压）传感器、溶氧传感器、霍尔传感器、图像传感器、超声波传感器、位移传感器、速度传感器、加速度传感器、扭距传感器、红外传感器、紫外传感器、火焰传感器、激光传感器、振动传感器、轴角传感器、光电传感器、接近传感器、干簧管传感器、继电器传感器、微型电泵、磁敏（阻）传感器、压力开关、接近开关、光电开关、色标传感器、光纤传感器、齿轮测速传感器、时间继电器、计数器、计米器、温控仪、固态继电器、调压模块、电磁铁、电压表、电流表等特殊传感器。同时承接传感器应用电路、产品设计和自动化工程项目。**

欢迎索取免费详细资料、设计指南和光盘；产品凡多，未能尽录，欢迎来电查询。

更多产品请看本公司产品专用销售网站：

中国传感器科技信息网：<http://www.sensor-ic.com/>工控安防网：<http://www.pc-ps.net/>

电子元器件网：<http://www.sunstare.com/>微波光电产品网：[HTTP://www.rfoe.net/](http://www.rfoe.net/)

消费电子产品网：<http://www.icasic.com/>军工产品网：<http://www.junpinic.com/>

实业科技产品网：<http://www.sunstars.cn/>传感器销售热线：

电话：0755-83607652 83376489 83376549 83370250 83370251

传真：0755-83376182 (0) 13902971329 MSN: SUNS8888@hotmail.com

邮编：518033 E-mail:szss20@163.com QQ: 195847376

技术支持：0755-83394033 13501568376