

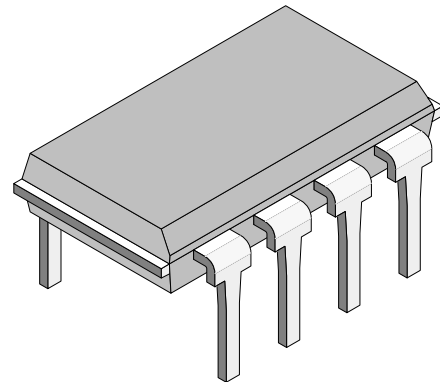


Silicon PIN Photodiode Array

Description

S268P is a silicon PIN photodiode array in a inline configuration.

Three single photodiode chips with a common cathode are mounted in a waterclear 8 pin dual in line package. Each chip measures 3mm by 3mm and provides a radiant sensitive area of 7.5 mm².



94 8684

Features

- Three photodiodes with common cathode
- Fast response times
- Small junction capacitance
- High photo sensitivity
- Large radiant sensitive area ($A = 3 \times 7.5 \text{ mm}^2$)
- Wide angle of half sensitivity $\varphi = \pm 65^\circ$
- Suitable for visible and near infrared radiation

Applications

High speed and high sensitive PIN photodiode array for industrial applications, measuring and control

Absolute Maximum Ratings

$T_{\text{amb}} = 25^\circ\text{C}$

Parameter	Test Conditions	Symbol	Value	Unit
Reverse Voltage		V_R	60	V
Power Dissipation	$T_{\text{amb}} \leq 25^\circ\text{C}$	P_V	215	mW
Junction Temperature		T_j	100	$^\circ\text{C}$
Storage Temperature Range		T_{stg}	-55...+100	$^\circ\text{C}$
Soldering Temperature	$t \leq 3 \text{ s}$, mounted on plated, printed board	T_{sd}	260	$^\circ\text{C}$
Thermal Resistance Junction/Ambient		R_{thJA}	350	K/W

S268P**Vishay Telefunken****Basic Characteristics** $T_{amb} = 25^{\circ}\text{C}$

Parameter	Test Conditions	Symbol	Min	Typ	Max	Unit
Breakdown Voltage	$I_R = 100 \mu\text{A}, E = 0$	$V_{(BR)}$	60			V
Reverse Dark Current	$V_R = 10 \text{V}, E = 0$	I_{ro}		2	30	nA
Diode Capacitance	$V_R = 0 \text{V}, f = 1 \text{MHz}, E = 0$	C_D		70		pF
	$V_R = 3 \text{V}, f = 1 \text{MHz}, E = 0$	C_D		25	40	pF
Open Circuit Voltage	$E_e = 1 \text{mW/cm}^2$	V_o		350		mV
Temp. Coefficient of V_o	$E_e = 1 \text{mW/cm}^2$	TK_{V_o}		-2.6		mV/K
Short Circuit Current	$E_A = 1 \text{klx}$	I_k		70		μA
	$E_e = 1 \text{mW/cm}^2, \lambda = 950 \text{nm}$	I_k		47		μA
Temp. Coefficient of I_k	$E_A = 1 \text{mW/cm}^2, \lambda = 950 \text{nm}$	TK_{I_k}		0.1		%/K
Reverse Light Current	$E_A = 1 \text{klx}, V_R = 5 \text{V}$	I_{ra}		75		μA
	$E_e = 1 \text{mW/cm}^2, \lambda = 950 \text{nm}, V_R = 5 \text{V}$	I_{ra}	40	50		μA
Reverse Light Current Ratio of Two Diodes					1:1.2	
Angle of Half Sensitivity		ϕ		± 65		deg
Wavelength of Peak Sensitivity		λ_p		900		nm
Range of Spectral Bandwidth		$\lambda_{0.5}$		600...1050		nm
Noise Equivalent Power	$V_R = 10 \text{V}, \lambda = 950 \text{nm}$	NEP		4×10^{-14}		$\text{W}/\sqrt{\text{Hz}}$
Rise Time	$V_R = 10 \text{V}, R_L = 1 \text{k}\Omega, \lambda = 820 \text{nm}$	t_r		100		ns
Fall Time	$V_R = 10 \text{V}, R_L = 1 \text{k}\Omega, \lambda = 820 \text{nm}$	t_f		100		ns

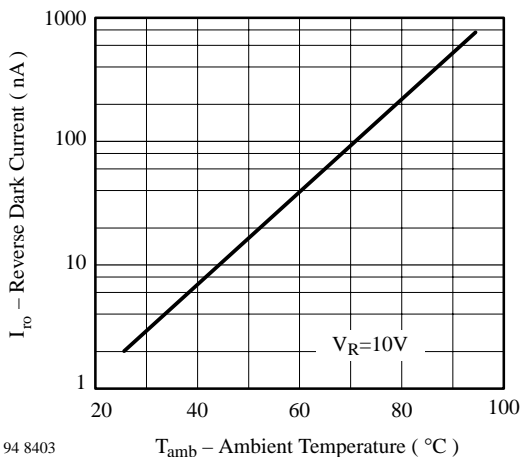
Typical Characteristics ($T_{amb} = 25^{\circ}\text{C}$ unless otherwise specified)

Figure 1. Reverse Dark Current vs. Ambient Temperature

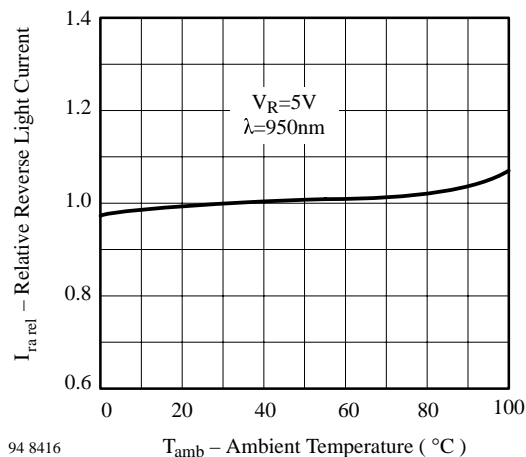
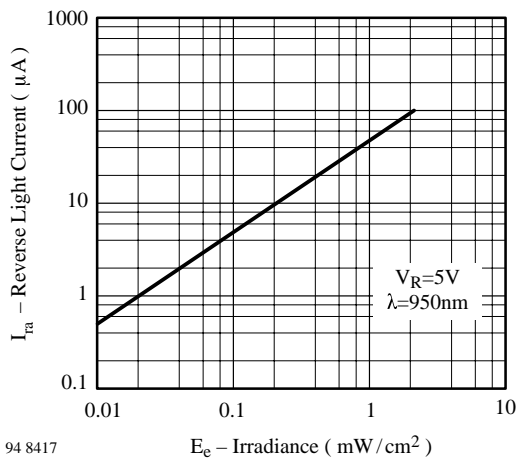
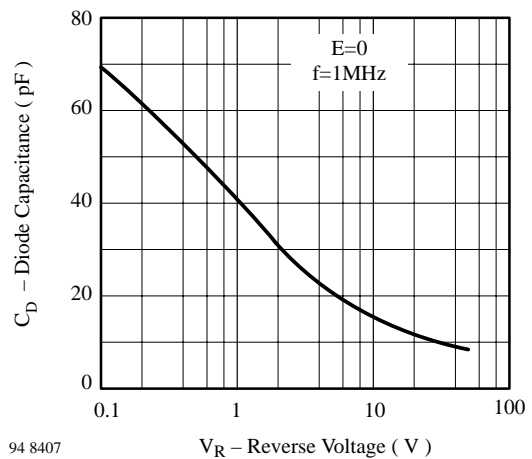


Figure 2. Relative Reverse Light Current vs. Ambient Temperature



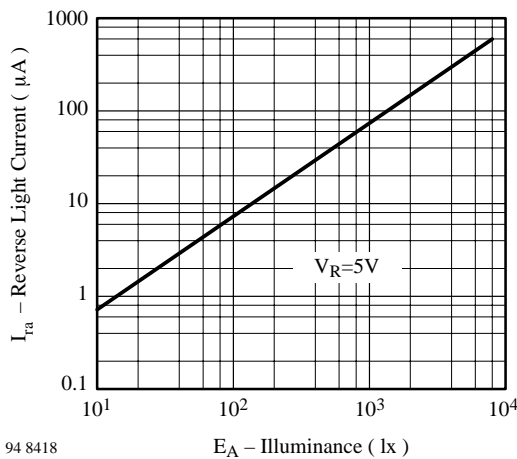
94 8417

Figure 3. Reverse Light Current vs. Irradiance



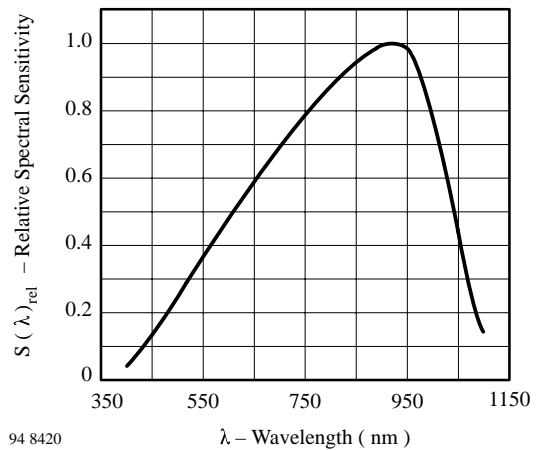
94 8407

Figure 6. Diode Capacitance vs. Reverse Voltage



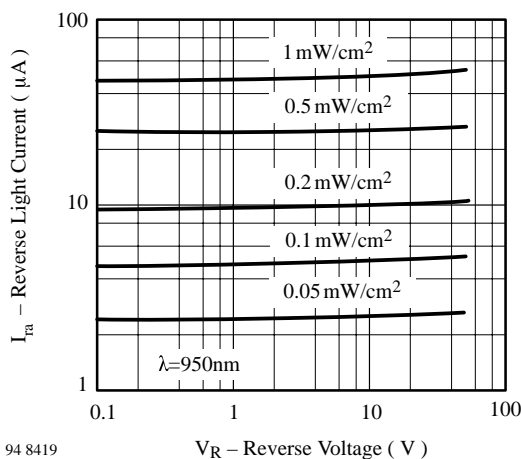
94 8418

Figure 4. Reverse Light Current vs. Illuminance



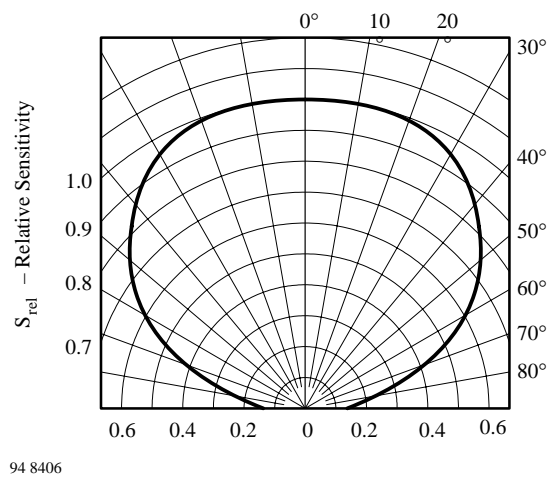
94 8420

Figure 7. Relative Spectral Sensitivity vs. Wavelength



94 8419

Figure 5. Reverse Light Current vs. Reverse Voltage



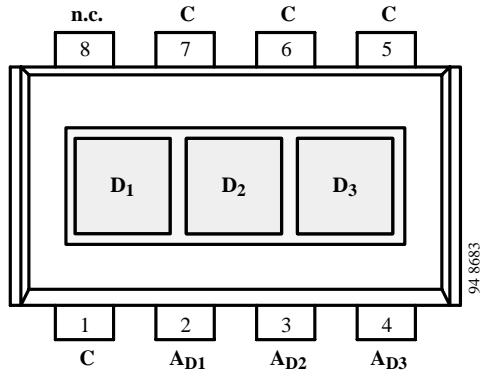
94 8406

Figure 8. Relative Radiant Sensitivity vs. Angular Displacement

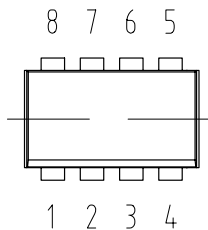
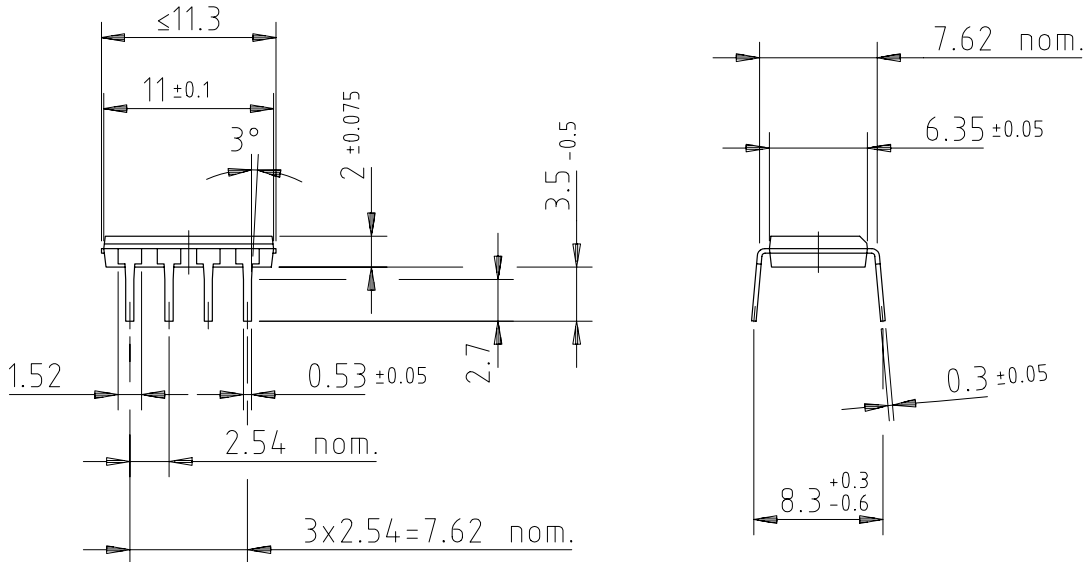
S268P



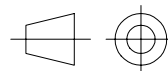
Vishay Telefunken



Dimensions in mm



96 12185



technical drawings
according to DIN
specifications



Ozone Depleting Substances Policy Statement

It is the policy of **Vishay Semiconductor GmbH** to

1. Meet all present and future national and international statutory requirements.
2. Regularly and continuously improve the performance of our products, processes, distribution and operating systems with respect to their impact on the health and safety of our employees and the public, as well as their impact on the environment.

It is particular concern to control or eliminate releases of those substances into the atmosphere which are known as ozone depleting substances (ODSs).

The Montreal Protocol (1987) and its London Amendments (1990) intend to severely restrict the use of ODSs and forbid their use within the next ten years. Various national and international initiatives are pressing for an earlier ban on these substances.

Vishay Semiconductor GmbH has been able to use its policy of continuous improvements to eliminate the use of ODSs listed in the following documents.

1. Annex A, B and list of transitional substances of the Montreal Protocol and the London Amendments respectively
2. Class I and II ozone depleting substances in the Clean Air Act Amendments of 1990 by the Environmental Protection Agency (EPA) in the USA
3. Council Decision 88/540/EEC and 91/690/EEC Annex A, B and C (transitional substances) respectively.

Vishay Semiconductor GmbH can certify that our semiconductors are not manufactured with ozone depleting substances and do not contain such substances.

We reserve the right to make changes to improve technical design and may do so without further notice.

Parameters can vary in different applications. All operating parameters must be validated for each customer application by the customer. Should the buyer use Vishay-Telefunken products for any unintended or unauthorized application, the buyer shall indemnify Vishay-Telefunken against all claims, costs, damages, and expenses, arising out of, directly or indirectly, any claim of personal damage, injury or death associated with such unintended or unauthorized use.

Vishay Semiconductor GmbH, P.O.B. 3535, D-74025 Heilbronn, Germany
Telephone: 49 (0)7131 67 2831, Fax number: 49 (0)7131 67 2423