

Model TR2 - Tru-Trac™ Encoder with Rack and Pinion Gearing

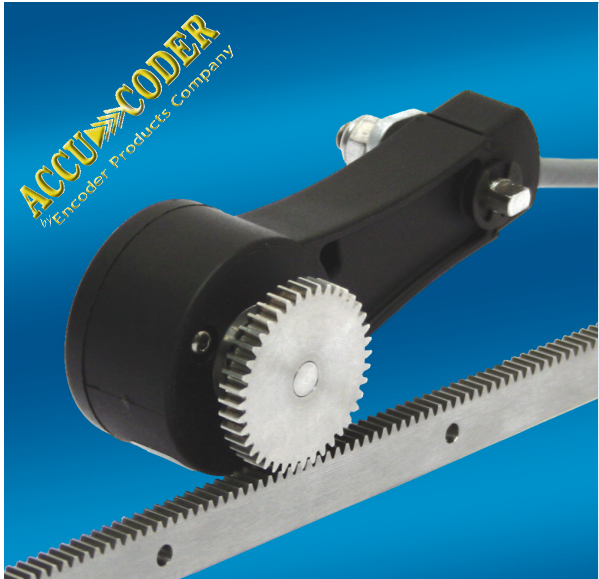

Features

- Encoder With Rack And Pinion Gear Integrated Into One Compact Unit
- Easily Installed In A Vertical, Horizontal, Or Upside-Down Orientation
- Operates At Speeds Up To 400 Feet Per Minute
- Spring Loaded Torsion Arm Eliminates Gear Backlash
- Integrated Module Simplifies Your System Design, Reducing Cost

Backlash B-Gone! At last, a linear encoder solution with no back-lash or slippage. The NEW TR2 Tru-Trac™ is a versatile solution for tracking velocity, position, or distance in almost any application, featuring an integrated encoder with a rack and pinion gear assembly. Using the Rack and Pinion gear system, encoder readings can be obtained with repeatable positioning, providing excellent accuracy. Racks can be ordered in varying lengths, and with the accessory spacer block, multiple lengths of rack can be joined for easy installation. Due to the spring loaded torsion arm, which provides simple to adjust torsion load, the TR2 has all the flexibility and maneuverability of the original TR1 Tru-Trac™. It has the ability to be installed in a horizontal, vertical, or upside down position. The threaded shaft on the pivot axis is field reversible, providing mounting access from either side, and the durable conductive composite housing material will eliminate static build up. With so many configuration options in a simple integrated encoder solution, it is easy to see that the TR2 is on the right track for success!

Common Applications

X-Y Tables, Gantry Systems, Packaging Machinery, Cut-To-Length, Printing, Labeling, Document Handling, Machine Shop Equipment

Model TR2 - Tru-Trac™ Ordering Guide

Blue type indicates price adder options. Not all configuration combinations may be available. Contact Customer Service for details.

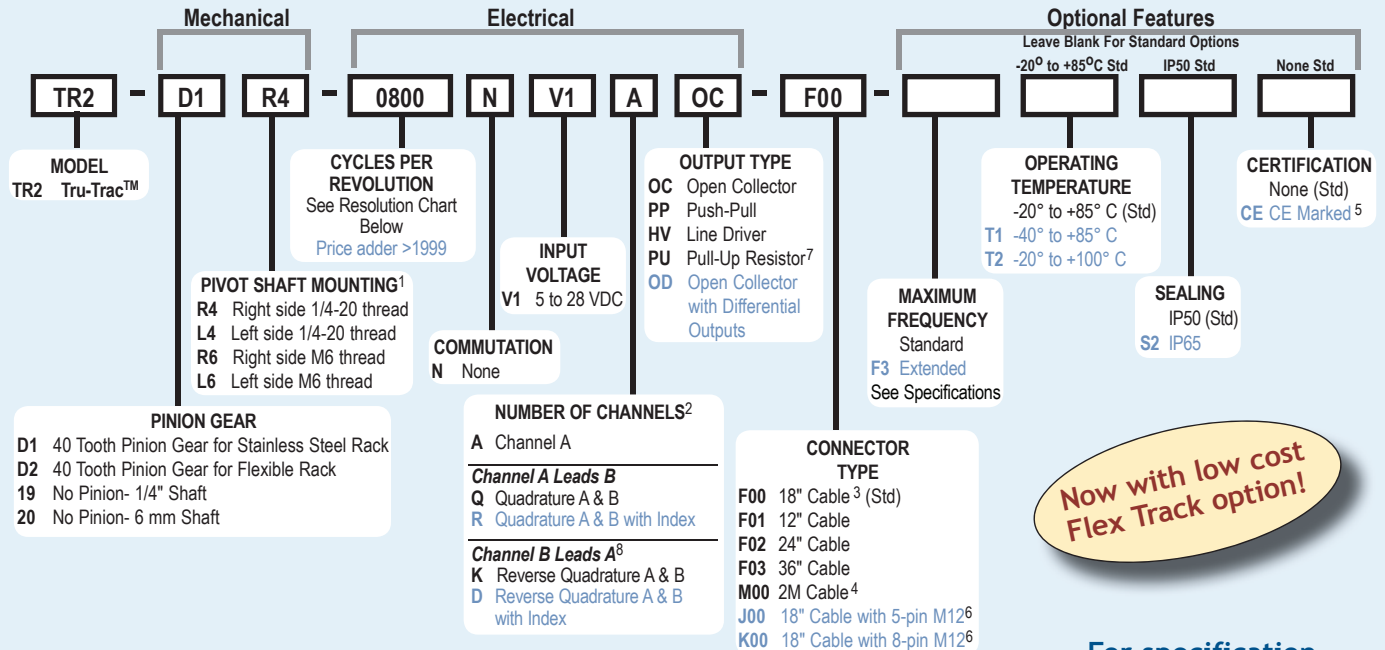

Now with low cost Flex Track option!

For specification assistance call
Customer Service at
1-800-366-5412

Model TR2 - Tru-Trac™ CPR Options

Red resolutions are common. See resolution charts for more information.

0001 thru 0189*	0198	0200	0250	0256
0300	0315	0360	0400	0512
0580	0600	0750	0800	1000
1125	1200	1250	1500	1800
2048	2500	2540	3000	3600
4096	5000	6000	7200	8192
				10,000

New CPR values are periodically added to those listed. Contact Customer Service to determine all currently available values. Special disk resolutions are available upon request and may be subject to a one time NRE fee.

NOTES:

- 1 See mechanical drawing. Shaft is reversible in the field.
- 2 Contact Customer Service for non-standard index gating or phase relationship options.
- 3 For non-standard English cable lengths enter 'F' plus cable length expressed in feet. Example: F06 = 6 feet of cable. Frequency above 300 kHz standard cable lengths only.
- 4 For non-standard metric cable lengths enter 'M' plus cable length expressed in meters. Example: M06 = 6 meters of cable.
- 5 Please refer to Technical Bulletin TB100: **When to Choose the CE Option** at www.encoder.com.
- 6 5-pin not available with Line Driver (HV) output. Additional cables lengths available.
- 7 With Input Voltage above 16 VDC, operating temperature is limited to 85° C.
- 8 Reverse Quadrature not available with PU output type.

Model TR2 - Tru-Trac™ Encoder with Rack and Pinion Gearing

Model TR2 - Tru-Trac™ Specifications

Electrical

- Input Voltage.....4.75 to 28 VDC max for temperatures up to 85° C
4.75 to 24 VDC for temperatures between 85° C to 100° C
- Input Current.....100 mA max (65 mA typical) with no output load
- Output Format.....Incremental - Two square waves in quadrature with channel A leading B for clockwise shaft rotation, as viewed from the wheel side. See *Waveform Diagrams* below.
- Output Types.....Open Collector- 20 mA max per channel
Push-Pull- 20 mA max per channel
Pull-Up- Open collector with 2.2K ohm Pull-Up 20mA max per channel
Line Driver- 20 mA max per channel (Meets RS 422 at 5 VDC supply)
- IndexOnce per revolution. 0190 to 10,000 CPR:
Gated to output A. 0001 to 0189 CPR:
Ungated
See *Waveform Diagrams* at right.
- Max. FrequencyStandard Frequency Response is 200 kHz for CPR 1 to 2540
500 kHz for CPR 2541 to 5000
1 MHz for CPR 5001 to 10,000
Extended Frequency Response (optional) is 300 kHz for CPR 2000, 2048, 2500, & 2540
- Noise ImmunityTested to BS EN61000-6-2; BS EN50081-2; BS EN61000-4-2; BS EN61000-4-3; BS EN61000-4-6, BS EN500811
- Quadrature67.5° electrical or better is typical, 54°
- Edge Separationelectrical minimum at temperatures > 99° C
- Waveform Symmetry.....180° (±18°) electrical (single channel encoder)
- AccuracyWithin 0.017° mechanical or 1 arc-minute from true position. (for CPR>189)

Mechanical

- Radial Shaft Load ..5 lb max. Rated load of 2 to 3 lb for bearing life of 1.2 x 10¹⁰ revolutions
- Axial Shaft Load.....5 lb max. Rated load of 2 to 3 lb for bearing life of 1.2 x 10¹⁰ revolutions
- Starting Torque.....IP50 0.05 oz-in
IP65 0.4 oz-in
- Electrical Conn.....18" cable (foil and braid shield, 24 AWG conductors), 5- or 8-pin M12 (12 mm) in-line connector with 18" cable (braid shield)
- MountingPivot shaft can be mounted from either side of the Tru-Trac™ housing, and is reversible in the field. Specify 1/4-20 or M6 threads
- Housing.....Stainless steel fibers in a high temperature nylon composite
- Weight.....5 oz typical

Environmental

- Operating Temp.....-20° to +85° C for standard models
-40° to +85° C for low temperature option
-20° to +100° C for high temperature option
- Storage Temp.....-25° to +85° C
- Humidity.....98% RH non-condensing
- Vibration.....10 g @ 58 to 500 Hz
- Shock80 g @ 11 ms duration
- SealingIP50 standard; IP65 available

Model TR2 - Tru-Trac™

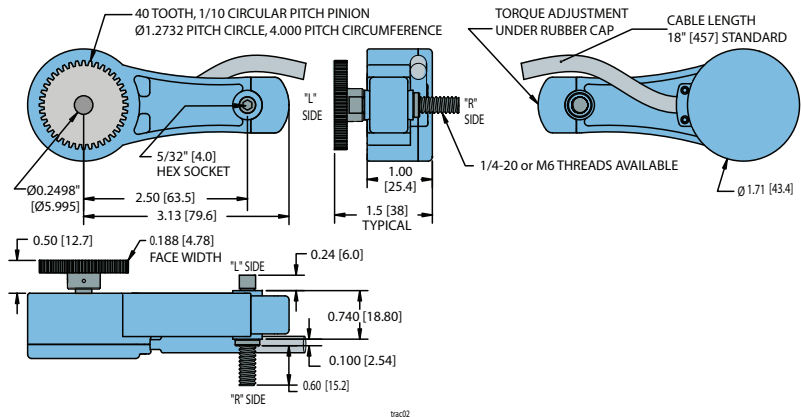

All dimensions are in inches with a tolerance of ±0.005" or ±0.01" unless otherwise specified. Metric dimensions are given in brackets [mm].

Resolutions- English Units

Inches Per Pulse	Pulses Per Inch	Disc Cycles Per Revolution
0.01	100	400
0.005	200	800
0.004	250	1000
0.002	500	2000
0.001	1000	2000*
0.0005	2000	2000**
0.0004	2500	2500**
0.0002	5000	2500***
0.0001	10,000	2500****

*Requires 2x external quadrature counting
**Requires 4x external quadrature counting
***Requires 2x Interpolation
****Requires 4x Interpolation

Waveform Diagram

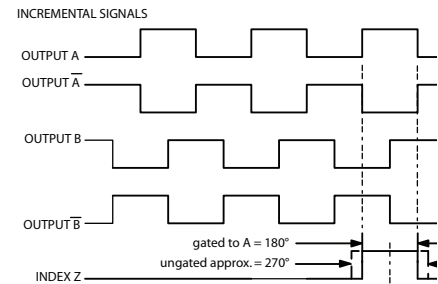

Waveform shown with optional complementary signals A, B, Z for HV and OD outputs only.

Resolutions- Metric Units

mm Per Pulse	Pulses Per mm	Disc Cycles Per Revolution
0.04	25	2540
0.02	50	2540*
0.01	100	2540**

*Requires 2x external quadrature counting
**Requires 4x external quadrature counting

Wiring Table

Function	Cable Wire Color	5-pin M12**	8-pin M12**
Com	Black	3	7
+VDC	White	1	2
A	Brown	4	1
A'	Yellow	--	3
B	Red	2	4
B'	Green	--	5
Z	Orange	5	6
Z'	Blue	--	8
Shield	Bare *	--	--

* CE Option: Cable shield (bare wire) is connected to internal case.
** Non-CE Option: Cable shield is connected to M12 connector body.
CE Option: Cable shield is connected to M12 connector body, and internal case.

Accessory Angle Mounting Bracket for TR2 Tru-Trac™ can be ordered separately as part # 140104
Dimensional drawing available at www.encoder.com

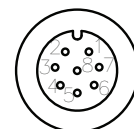
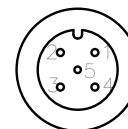

Model TR2 - Tru-Trac™ Encoder with Rack and Pinion Gearing

Model TR2 - Tru-Trac™ Specifications for Stainless Steel & Flexible Rack

Mechanical - Stainless Steel Rack

Max Linear Speed... 400 Feet Per Minute. Speeds over 200 FPM require lubricant, such as MoS₂ paste, to reduce gearing wear. Higher speeds may be achievable, contact Customer Service.

Rack

Material 303 Stainless Steel
Gearing Tolerance... AGMA 10, 20 degree pressure angle teeth
Accuracy ±0.0005 inch/inch max accumulated error
Repeatability ±0.0001 inch

Mechanical - Flexible Rack

Max Linear Speed... 200 Feet Per Minute

Rack Material Acetal
Gearing Geometry .. 20° pressure angle teeth
Accuracy ±0.002 inch/inch max accumulated error
Repeatability ±0.001 inch for Flexible Rack

Model TR2 - Tru-Trac™ Applications

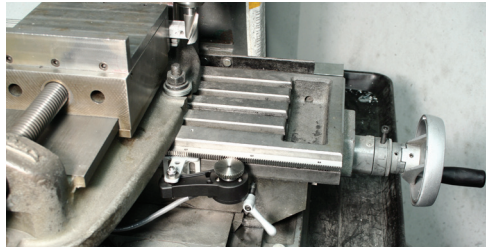

Racks and Accessories for the TR2 (Rack Must Be Ordered Separately)

Part #	Length
176216	12" for Stainless Steel
176217	24" for Stainless Steel
176218	36" for Stainless Steel
176219	Spacer Block for Stainless Steel
161546	2 meter flexible rack
161548	Flexible rack clamps 10 pk (with M4x0.7 x 1) mm Phillips pan head machine screws.
161547	1 meter guide rail for flexible rack (does not work with 176220 gear)
140104	Angle Mounting Bracket
176220	40 Tooth Pinion Gear for use with Stainless Steel Rack
176302	40 Tooth Pinion Gear for use with Flexible Rack

See drawings for rack dimensions. For lengths over 36", order multiple pieces of stainless steel rack or the flexible option. A spacer block must be used to accurately join two or more pieces of rack. See Technical Bulletin TB-522 or TB-523 for details.

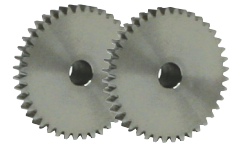

Additional Pinion Gears for TR2 Tru-Trac™ can be ordered separately as part # 176220 (stainless steel rack) or # 176302 (flexible rack).

Model TR2 - Tru-Trac™ Stainless Steel Rack

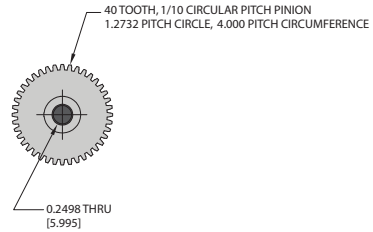
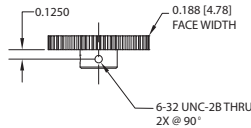

PRECISION AGMA 10 PINION FOR RIGID RACK

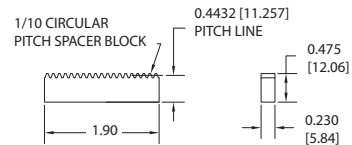
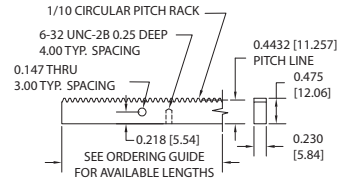

Model TR2 - Tru-Trac™ Flexible Rack

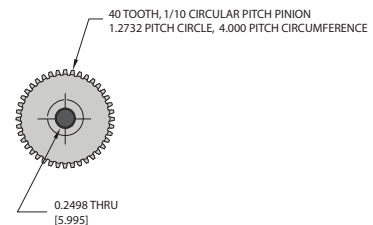
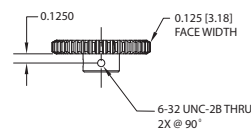

0.125 FACE WIDTH PINION FOR FLEXIBLE RACK

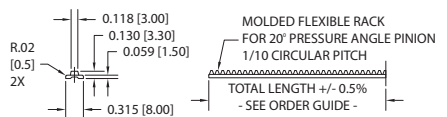

MOLDED FLEXIBLE RACK FOR 20° PRESSURE ANGLE PINION 1/10 CIRCULAR PITCH TOTAL LENGTH +/- 0.5% - SEE ORDER GUIDE -