

A2TPMI[®] 23S

Thermopile with integrated signal processing circuit in SMD housing



Description

The Excelitas A2TPMI[®] is a versatile infrared thermopile sensor with an integrated configurable ASIC for signal processing and ambient temperature compensation. This integrated infrared module senses the thermal radiation emitted by objects and converts this to an analog voltage.

The A2TPMI is delivered fully factory calibrated and adapted to the customer specification. Therefore only three pins are necessary for operation: object output voltage, 5 V supply voltage, and ground.

As compared to discrete sensors, the integrated sensor modules of the A2TPMI series feature several advantages:

- Internal offset correction of the amplifier.
- A factory calibrated ambient temperature sensor that allows for precise internal ambient temperature compensation.
- The amplification of the highly sensitive thermopile signal in the micro- to millivolt range is performed by a high resolution programmable low noise chopper amplifier.
- Two configurable comparators can optionally be used to enhance the functionality. This allows employing the A2TPMI as a temperature dependent switch for alarm purposes.

- Due to integration of sensor and electronic into the housing, the A2TPMI is robust and insensitive to environmental influences like pcb contamination (leakage currents), humidity and electromagnetic interference.

The compact ceramic SMD housing additionally offers a range of advantages over a classical TO-housing:

- Automated assembly is possible.
- Smaller size
- Superior thermal properties, allowing the sensor to operate reliably in challenging environments with thermal gradients and ambient temperature changes.

Features and Benefits

- Smart thermopile sensor with integrated signal processing.
- Can be adapted to your specific measurement task.
- Integrated, calibrated ambient temperature sensor.
- Output signal ambient temperature compensated.
- Fast reaction time.
- Different optics and IR filters available.
- Digital serial interface for calibration and adjustment purposes.
- Analog front end / back end, digital signal processing.
- E²PROM for configuration and data storage.
- Configurable comparator with high / low signal for remote temperature threshold control.
- Small SMD package.

Applications

- Miniature remote non-contact temperature measurement (pyrometer).
- Temperature dependent switch for alarm or thermostatic applications.
- Residential, commercial, automotive, and industrial climate control.
- Household appliances featuring a remote temperature control like microwave oven, toaster, hair dryer.
- Temperature control in laser printers and copiers.

Table of Contents

Functional Diagram	3
Absolute Maximum Ratings	3
Electrical Characteristics	4
AC Characteristics	4
Thermopile Characteristics	4
V_{Tobj} / V_{Tamb} Characteristics	4
Optical Characteristics	4
Soldering	4
Packaging Information	4
Quality Statement	4
Liability Policy	4

Functional Diagram

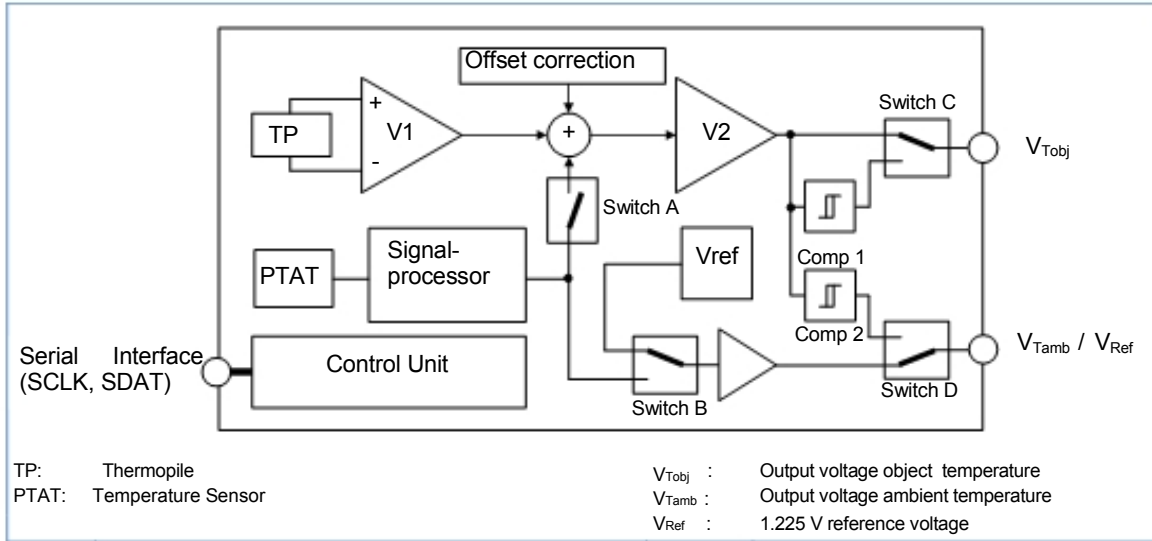

Absolute Maximum Ratings

Parameter	Min	MAX
Supply voltage V_{DD}	-0.3 V	+6.5 V
Storage temperature range ^{Note 1)}	-40° C	100° C
Operating temperature range	-25° C	100° C
Voltage at all inputs and outputs ^{Note 2)}	-0.3 V	$V_{DD} + 0.3 V$
Current at input pins ^{Note 2)}		+/- 5 mA
ESD tolerance ^{Note 3)}		2.5 kV

Note 1: Extension to 120° C for limited periods of several minutes possible.

Note 2: Limiting input pin current is only necessary for input voltages that exceed absolute maximum input voltage ratings. **Note**

3: Human body model, 1.5 kΩ in series with 100 pF. All pins rated per method 3015.7 of MIL-STD-883.

Static-sensitive device. Unused devices must be stored in conductive material. Protect devices from static discharge and static fields. Stresses above those listed under “Absolute maximum ratings” may cause permanent damage to the device. Exposure to absolute maximum rating conditions for extended periods may affect device reliability. Precautions should be taken to avoid reverse polarity of power supply. Reversed polarity of power supply results in a destroyed unit.

Do not expose the sensors to aggressive detergents such as freon, trichlorethylen, etc.

Optical windows (e.g. filter, lens) may be cleaned with alcohol and a cotton swab.

Electrical Characteristics

Symbol	Parameter	Min	Typ	Max	Unit	Conditions
Power Supply						
V _{DD}	Supply voltage	4.5	5	5.5	V	
I _{DD}	Supply current		1.5	2	mA	R _L > 1 MΩ
Outputs V_{Tobj} / V_{Tamb}						
VO	Output voltage swing	0.25		V _{DD} - 0.25 V	V	I _{out} : -100 μA ... +100 μA
RO	Output resistance			100	Ω	
RL	Resistive output load	50			kΩ	
CL	Capacitive output load		100	500	pF	
ISC	Output short circuit current		6		mA	Sourcing
			13		mA	Sinking
Serial Interface SDAT, SCLK						
V _{oL}	Low level output voltage			0.5	V	Output current ≤ 2 mA
V _{oH}	High level output voltage	V _{DD} - 0.6 V			V	Output current ≥ 2 mA
Reference Voltage						
V _{Ref}	Reference voltage	1.223	1.225	1.227	V	R _L > 1 MΩ, T _{amb} = 25° C
TC _{VRef}	Temperature coefficient of reference voltage		±30	±100	ppm K ⁻¹	

Unless otherwise indicated, all limits specified for T_{amb} = 25° C, V_{DD} = +5 V

AC Characteristics

Symbol	Parameter	Min	Typ	Max	Unit	Conditions
I _{NN}	V1 Input referred voltage noise			120	nV/√Hz	rms value
t _{strt}	Response time after power on			1	s	
t _{lat}	Latency time for V _{Tobj}			75	ms	
t _{resp}	Response time		90	150	ms	

Unless otherwise indicated, all limits specified for T_{amb} = 25° C, V_{DD} = +5 V

Thermopile Characteristics

Symbol	Parameter	Min	Typ	Max	Unit	Conditions
2-type chip						
S	Sensitive (absorber) area		0,2		mm ²	
N	Noise voltage		42		nV/√Hz	
τ	Time constant		15		ms	

V_{Tobj} / V_{Tamb} Characteristics

The V_{Tobj} and the V_{Tamb} characteristics of thermopile sensors depend not only on object and ambient temperature but on several other factors like object size to spot size relation, ambient temperature compensation behaviour or optical filter characteristics. Therefore it is not possible to specify a general V_{Tobj} and V_{Tamb} characteristic. Those characteristics will be specified application specific in a separate customer specification.

Optical Characteristics

Symbol	Parameter	Min	Typ	Max	Unit	Conditions
	Field of view		120		degree	At 50% relative output signal
	Optical axis		0	+/- 10	degree	

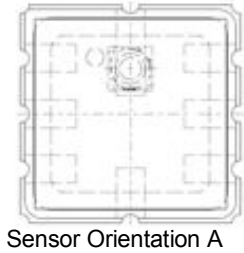
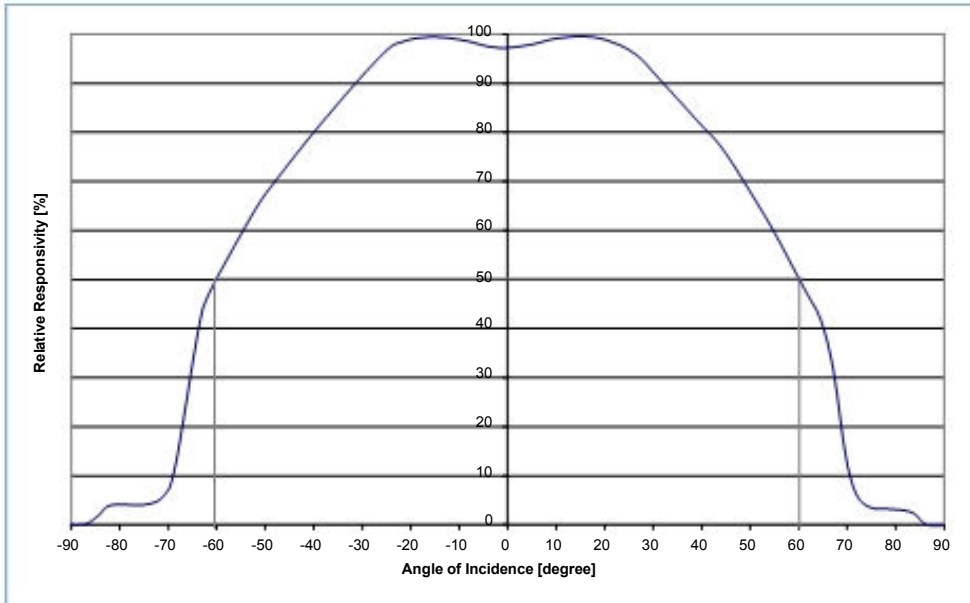

Figure 1 Typical Field of View Curve (Sensor Orientation A)

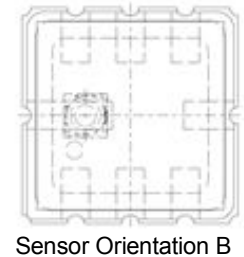
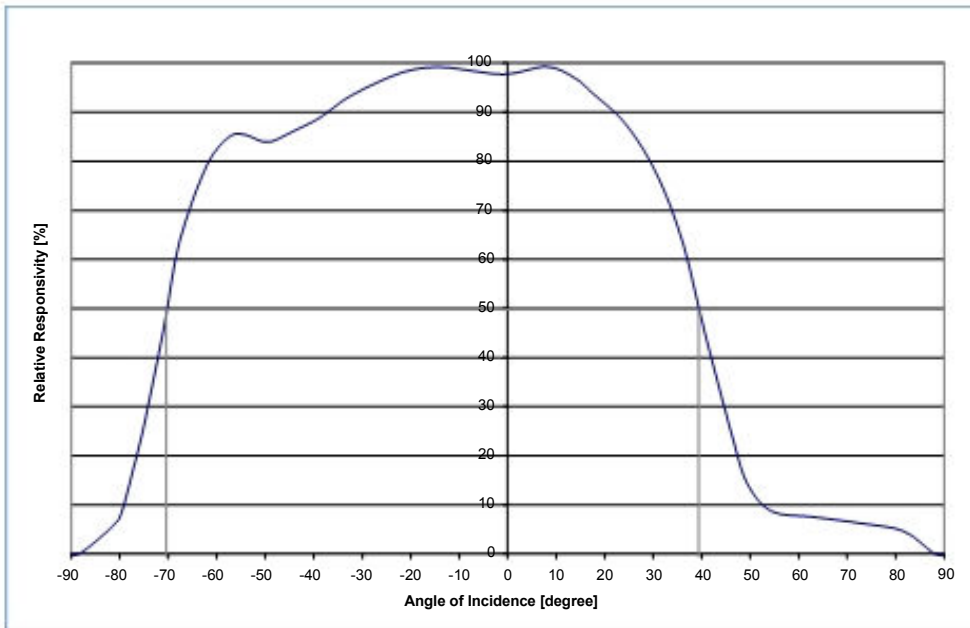

Figure 2 Typical Field of View Curve (Sensor Orientation B)

Symbol	Parameter	Min	Typ	Max	Unit	Conditions
T _A	Average transmittance	75	> 77		%	Wavelength range from 7.5 μm to 13.5 μm
T _A	Average transmittance			< 0.5	%	Wavelength range < 5 μm
λ (5 %)	Cut on wavelength	5.2	5.5	5.8	μm	At 25°C

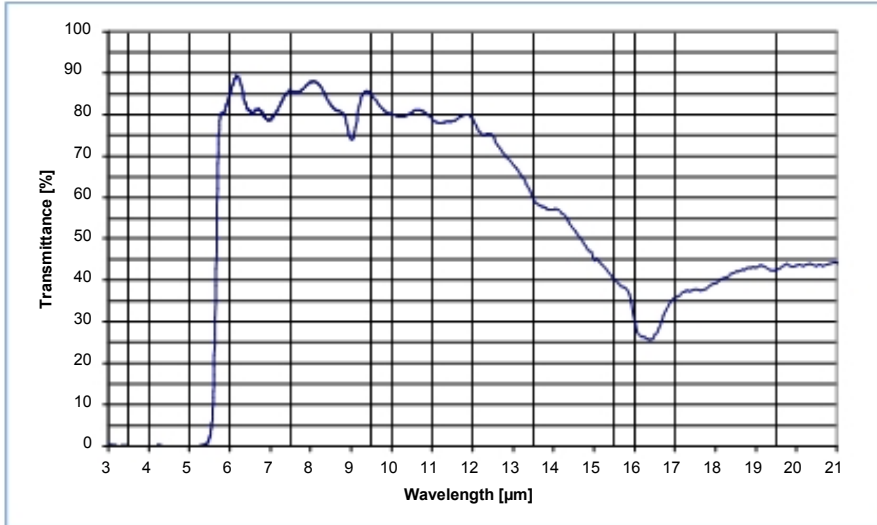

Figure 3 Transmission Curve for Excelitas Standard Filter

Soldering

The A2TPMI 23S is a lead-free component and fully complies with the RoHS regulations, especially with existing roadmaps of lead-free soldering. Reflow soldering is recommended. A typical lead free reflow profile is shown in figure 4. Specific reflow soldering parameters depend on the solder alloy used. The device meets MSL3 at 245 °C according to JEDEC standard.

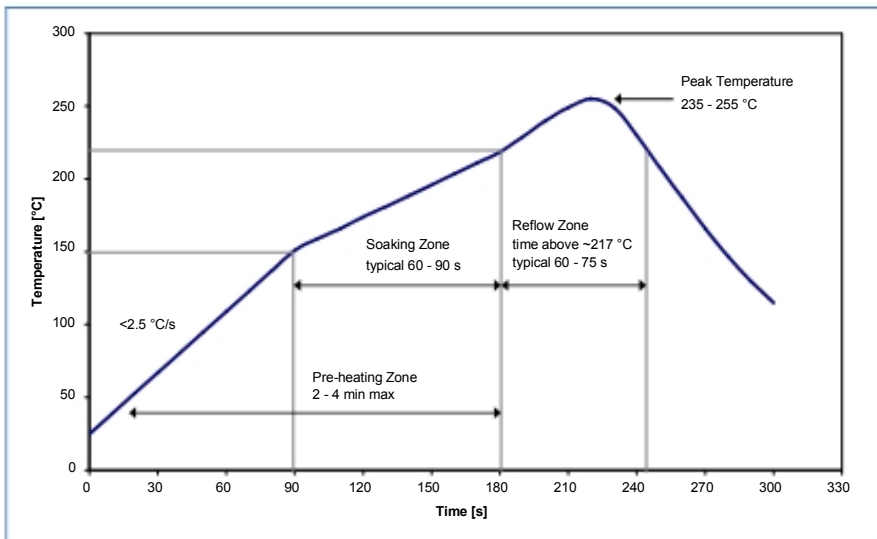

Figure 4 Typical Lead Free Reflow Profile

Packaging Information

<p>TP-Chip Cavity</p> <p>5.0±0.15</p> <p>1.46</p> <p>0.36</p> <p>5.0±0.15</p>	<p>1.8±0.25</p>
<p>VSS</p> <p>VDD</p> <p>ATPM</p> <p>SDAT</p> <p>SCLK</p> <p>ATEMP</p> <p>1.27±0.15</p> <p>1.27±0.15</p> <p>2.54±0.15</p> <p>0.64±0.15</p> <p>2.08±0.15</p>	

Quality Statement

Excelitas is an ISO 9001:2002 and ISO/TS 16949:2002 certified manufacturer. All devices employing PCB assemblies are manufactured according to IPC-A-610 guidelines.

Liability Policy

The contents of this document are subject to change without notice and customers should consult with Excelitas sales representatives before ordering. Customers considering the use of Excelitas thermopile devices in applications where failure may cause personal injury or property damage, or where extremely high levels of reliability are demanded, are requested to discuss their concerns with Excelitas sales representatives before such use. The Company's responsibility for damages will be limited to the repair or replacement of defective product. As with any semiconductor device, thermopile sensors or modules have a certain inherent rate of failure. To protect against injury, damage or loss from such failures, customers are advised to incorporate appropriate safety design measures into their product.

Excelitas Technologies
22001 Dumberry Road
Vaudreuil-Dorion, Québec
Canada J7V 8P7
Telephone: (+1) 450-424-3300
(+1) 866-574-6786 (toll-free)
Fax: (+1) 450-424-3345
generalinquiries@excelitas.com

European
Wenzel-Jaksch-Strasse 31
65199 Wiesbaden, Germany
Telephone: (+49)611-492-247
Fax: (+49)611-492-170

Asia
47 Ayer Rajah Crescent #06-12
Singapore 139947
Telephone: (+65)6775-2022
(+65)67704-366
Fax: (+65)6775-1008

EXCELITAS
TECHNOLOGIES

For a complete listing of our global offices, visit www.excelitas.com
©2011 Excelitas Technologies Corp. All rights reserved. The Excelitas logo and design are registered trademarks of Excelitas Technologies Corp. TPMI® is a trademark of Excelitas Technologies or its subsidiaries in the United States and other countries. All other trademarks not owned by Excelitas Technologies or its subsidiaries that are depicted herein are the property of their respective owners. Excelitas reserves the right to change this document at any time without notice and disclaims liability for editorial, pictorial or typographical errors.
600260_01 DTS0408