

MICRO SWITCH General Technical Bulletin No. 13

LOW ENERGY SWITCHING

Table of Contents

	Page
INTRODUCTION.....	3
LOW ENERGY SWITCHING.....	3
MECHANICAL PERFORMANCE.....	4
Plunger Movement Characteristics.....	4
Plunger Force vs. Plunger Position.....	5
Circuit Terminology.....	5
ELECTRICAL PERFORMANCE.....	6
Insulation Resistance.....	6
Dielectric Strength.....	6
Switch Resistance.....	6
Contact Resistance.....	7
Load Resistance.....	7
Measurement of Switch Resistance.....	7
Switch Resistance in Application.....	8
Role of Contamination in Switch Resistance.....	9
Common Contact Materials.....	10
Common Contact Configurations.....	11
Switch Life.....	12
GENERAL APPLICATION GUIDELINES.....	13
Storage, Installation, and Maintenance.....	13
Design.....	14
Environment.....	15
SUMMARY.....	15

INTRODUCTION

In today's age of low energy control, electromechanical switches are more frequently interfacing directly with computers and other low energy driven hardware. Switching low energy loads presents a unique challenge as compared to switching higher energy loads and at times requires an alternative switch design.

The purpose of this bulletin is to provide general information about mechanical and electrical performance of electromechanical switches, along with application guidelines for using electromechanical switches in low energy applications.

LOW ENERGY SWITCHING

Low energy switching can be described as using a switch to control any component(s) of a circuit where the load that the contacts will switch will not cause an arc to form between the contacts. Common names for these types of circuits are thermocouple load, dry circuit, logic level, etc.

The primary concern in the area of low energy switching is contact contamination. Since low energy loads do not arc or burn the contact surface, they also do not arc or burn off the contaminants that may reside on the contact surface. These contaminants may cause erratic switch resistance and can stop current flow. Pay special attention to the General Application Guidelines if the switch is to be used in a low energy application.

MECHANICAL PERFORMANCE

Plunger Movement Characteristics of a Basic Switch

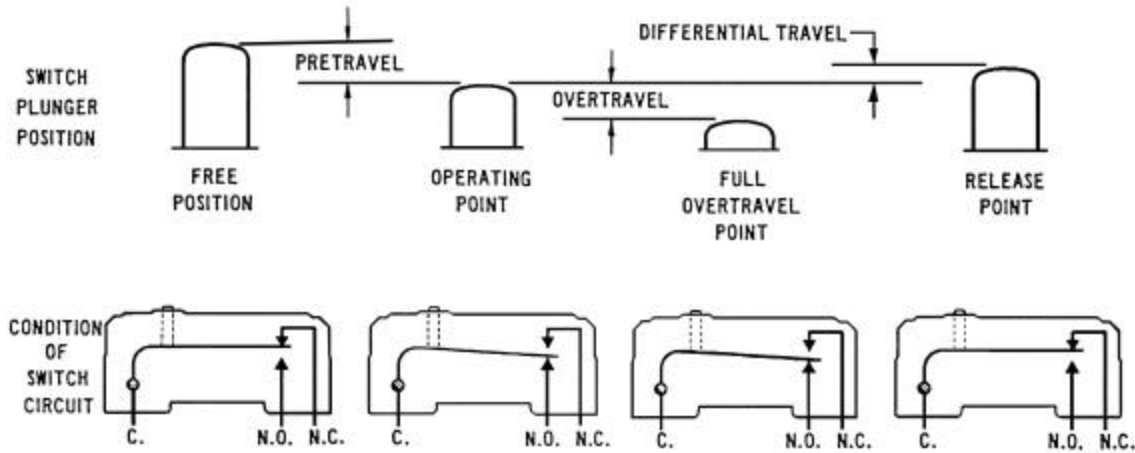

Free Position: Switch plunger is fully released and common contact is against normally closed contact.

Pretravel: Distance from free position to operating point.

Operating Point: Common contact transfers from normally closed contact to normally open contact.

Overtravel: Distance plunger travels past operating point.

Full Overtravel Point: Point at which further plunger depression is prevented by switch mechanism.

Release Point: Common contact transfers from normally open contact to normally closed contact.

Differential Travel: Distance between operating point and release point.

Operating Force: Force required to depress switch plunger to operating point.

Full Overtravel Force: Force required to depress switch plunger to full overtravel point.

Release force: Force required to allow the plunger to return to release point.

The movement of the switch plunger from the free position through the release point is considered one **cycle** of switch operation.

Plunger Force vs. Plunger Position

The graph at the right represents the relationship between plunger travel and plunger force and is of interest when the mechanism used to operate the switch is a force-sensitive device such as a dead weight, a thermostatic bimetal or a gas-filled bellows.

For data on a specific switch type, contact the- MICRO SWITCH Application Center at 1-800-537-6945.

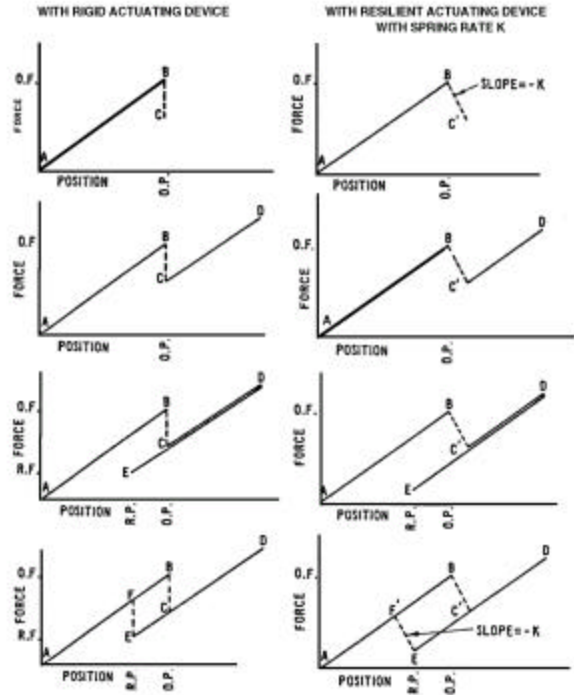

Circuitry Terminology

Pole: The number of completely separate circuits that can pass through the switch at one time.

Throw: The number of different circuits that each pole can control.

Break: The number of pairs of separated contacts the switch introduces into each circuit it opens.

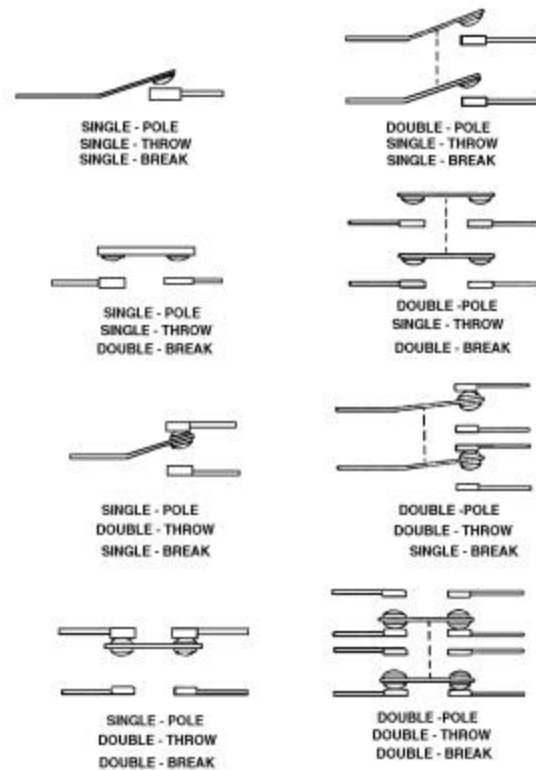

ELECTRICAL PERFORMANCE

Insulation Resistance Applied voltage divided by the current is the electrical resistance of the insulation. For new switches at commonly used voltages, insulation resistance usually exceeds 100,000 megohms between non-connected terminals and between terminals and switch housing. The voltage does put an electrical stress on the material but does not damage it unless the potential exceeds the dielectric strength of the switch.

Dielectric Strength Dielectric strength is the highest electrical potential that an insulating material can withstand without breaking down, i.e., dielectric breakdown. New switches usually have dielectric strength of over 1000 volts with leakage current less than 500 microamps. When the voltage exceeds the dielectric strength, the insulating material is permanently damaged.

Insulation Resistance and Dielectric Strength

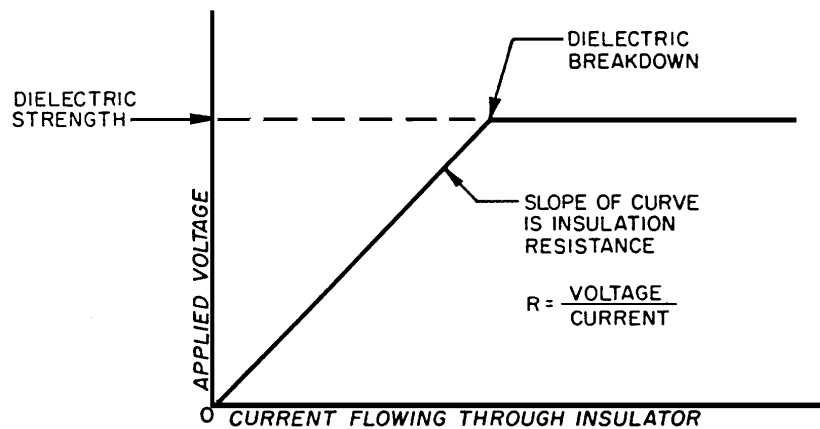

Switch Resistance Switch Resistance is the total resistance of the conducting path between the wiring terminals of the switch.

Sources of Switch Resistance

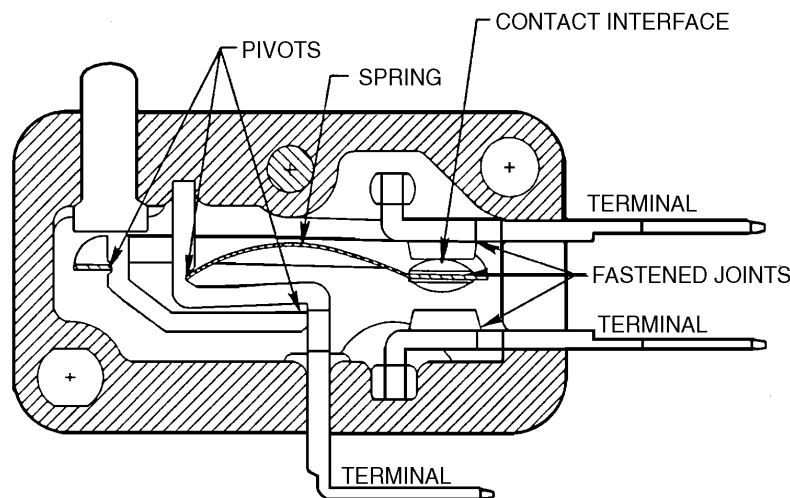

Typical Pattern of Switch Resistance versus Plunger Position at 6 Volts DC, 0.1 Ampere

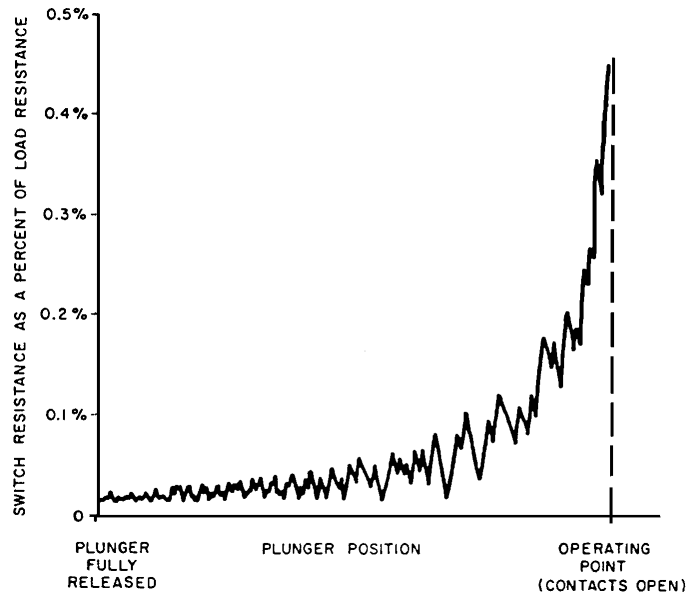

Contact Resistance: The resistance between a pair of closed contacts.

Load Resistance: Load resistance affects contact resistance in the following way; if the circuit voltage exceeds the softening or melting voltage of the contact material, the material softens or melts due to I^2R heating. See table below for softening and melting voltage of silver and gold.

Material	Approximate Softening Voltage	Approximate Melting Voltage
Silver	.09 Volt	.37 Volt
Gold	.08 Volt	.43 Volt

If the metal at the contact interface softens or melts, the cross-sectional area of the conducting path between the contacts will depend upon the current. The size of this cross-sectional area determines contact resistance. The higher the current, the greater the cross-sectional area of the bridge and the lower its resistance. If the softening voltage is not reached, the contact resistance is independent of current.

Measurement of

Switch Resistance: Switch resistance should be measured by voltage drop using the same voltage and current as in the circuit in which the switch is to be used. This can be accomplished by connecting the switch in a series circuit consisting of a power supply of the specified voltage, a variable resistor and ammeter.

Connections for Measurement of Switch Resistance

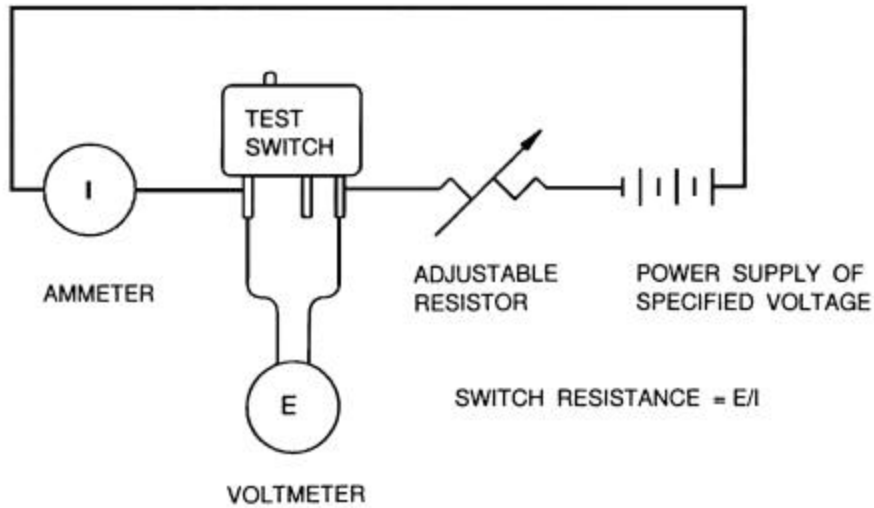

Switch Resistance

in Application: In the application of snap-acting switches, if the source voltage is at least .5 volts, contact material almost always softens, or melts slightly, at the interface, and switch resistance becomes a function of current. This leads to the following practical consequences:

1. In low current circuits, switch resistance tends to be relatively high. However, low current circuits usually have high resistance load components. The resistance of the switch usually is such a small part of the total resistance of the circuit that switch resistance is not a problem.
2. High current circuits usually have low-resistance load components. In high current circuits however, switch resistance tends to be low. Again, the resistance is such a small part of the total resistance of the circuit that switch resistance is not a problem.

At source voltages of 0.5 volt or greater, the resistance of a switch during its life will rarely exceed 1% of the load resistance. If source voltage is less than 0.5 volt, switch resistance may or may not be a function of current, depending upon the amount of the source voltage that appears across the contacts.

In general, the maximum allowable switch resistance of a specific application can be defined as follows: For DC circuits, the maximum allowable switch resistance equals the line voltage divided by the minimum allowable current, minus the load resistance. For AC circuits, the maximum allowable switch resistance equals the line voltage divided by minimum allowable current, multiplied by the power factor and minus the load resistance.

For example, consider a switch in series with a relay coil:

- 24 VDC, 5000 ohm coil, operate .004 amp, release .0025 amp.
- Without the switch in the circuit, $I=.0048$
- With the switch in circuit, coil will operate at $I=.004$. Switch resistance will do no harm if it does not reduce the .0048 amp to less than .004 amp
- Total resistance that will allow .004 amp flow = $R = V/I = 24 \text{ volts}/.004 \text{ amp} = 6000 \text{ ohms}$
- Therefore, maximum allowable switch resistance = 6000 ohms - 5000 ohms or 1000 ohms

Role of Contamination in Switch Resistance:

There are two general classifications for switch contaminants, particles and films. Particles can be crushed solids that enter the switch during application or assembly. Particles deposit on the contact surface, are crushed between the contacts and can become embedded in the contact material due to contact force. Particles can cause erratic contact during wipe and roll of contacts and, if large or extensive enough, can stop current flow.

Films are the second type of switch contaminant, which can be broken into two parts, organic and inorganic. Inorganic films, such as silver oxides or silver sulfides, do not typically cause switch resistance problems at the contacts. Silver oxide is conductive, so it does not represent a problem. Silver sulfide films are brittle and are punctured mechanically due to contact force and wiping action.

There are several types of contaminants that can create organic films and cause resistance problems. The most common are flux, organic vapors, and silicones. Flux enters the switch cavity by vapor or is carried into the switch cavity by a cleaning solvent. Flux will increase switch resistance and can stop current flow. To avoid flux contamination: avoid use of activated flux; use flux sparingly; use flux core solder; do not allow liquid flux or flux vapor to enter the switch; use a soldering temperature of approximately 550° F (288° C); and, do not use solvents on or near switches - they carry flux residue and other contaminants into the switch. It is not necessary to remove flux residue from terminals.

Organic materials, especially organic vapors, can decompose in the arc or I^2R heating of the material at the interface between the closed contacts. Carbonaceous deposits can build up over time on the contact surface and increase the switch resistance.

Silicon is an inorganic element found in many materials. Silicone is an organic material commonly found in oils, greases, mold release, cleaning sprays, and potting material. Silica (SiO₂), commonly referred to as glass, is transformed from silicone in the presence of electrical energy. Silicones enter the switch as vapor and over time, based on load, rate of actuation, and amount of silicone present, transform into silica. These silica deposits can raise switch resistance and stop current flow. Every precaution should be taken in the application to prevent silicone from coming in contact with the inner switch cavity.

Common Contact

Materials:

- **Fine silver.** 1.6 ohms/cm, low cost, if kept clean, there is no lower load limit.
- **24 karat gold.** 2.36 ohm/cm, high cost, limited to use in applications with little or no arc energy because of its ductility.
- **Gold Alloys.** Different properties depending on the alloy.
- **Gold clad over silver.** If the load is low energy, it is carried through gold. If the load is arcing, it burns away the gold and is carried through silver contacts. However, a switch that has seen an arcing load should not be used for a low energy load.
- **Silver Cadmium Oxide.** Designed for use in power loads, not recommended for use in loads less than .5 amp and/or 12 volts.

The following graph can be used as a *general* guide for the selection of contact material. The graph indicates 1st choice, 2nd choice, etc. for each current range. Note, the current represented on the X axis is steady-state. Inrush currents from motor loads and lamp loads can be 6 to 10 times steady state current.

General Guide to the Selection of Contact Material

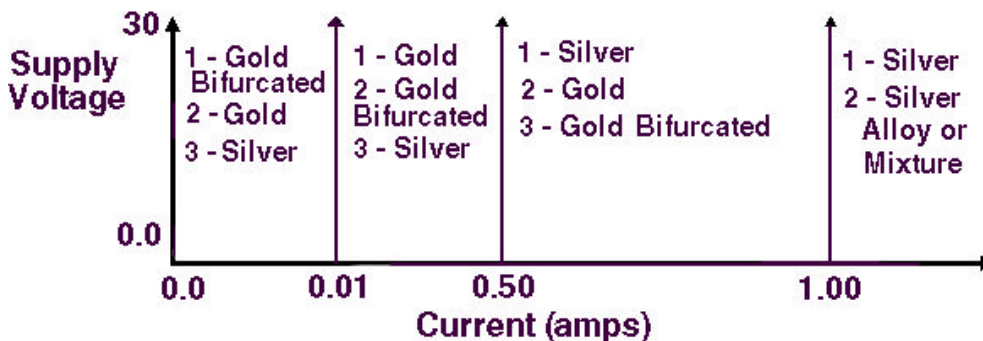

Common Contact Configurations:

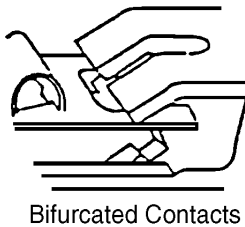
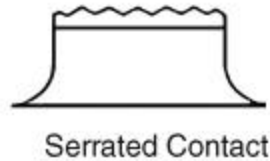

Smooth contact. Common contact configuration

Serrated contact. The top surface of the contact can be serrated to provide a series of peaks and valleys. When the switch is operated the raised areas (peaks) tend to scruff or scrape over the mating contact surface. This self-cleaning discourages buildups of films or particulate foreign material on the raised areas. Even when the minute particles are not totally removed, they tend to drop into the valleys where they are less likely to contaminate the contact interface. Serrated contacts have been effective in improving electrical continuity in applications ranging from power duty loads to low current requirements.

Bifurcated contacts. The most effective system developed to date. Bifurcated contacts offer some of the same benefits as described for serrated contacts in addition to providing parallel redundancy.

Redundancy can also be provided by connecting two or more switches in parallel and actuating them at the same time.

NOTE: Not all contact configurations are available on all switch types. For more information regarding the availability of different contact configurations on specific switch types, contact the MICRO SWITCH Application Center at 1-800-537-6945.

Switch Life: Mechanical life: The life of a switch with no electrical load present.

Electrical life: The life of a switch when switching an electrical load.

The following graph demonstrates the life of switch at different electrical loads. Switch life depends on such criteria as electrical load, environment, switch mechanism, and other factors particular to the application. As electrical load increases, switch life decreases. Below 1 amp, the electrical life approaches the mechanical life of the switch. For available test data, contact the MICRO SWITCH Application Center at 1-800-537-6945.

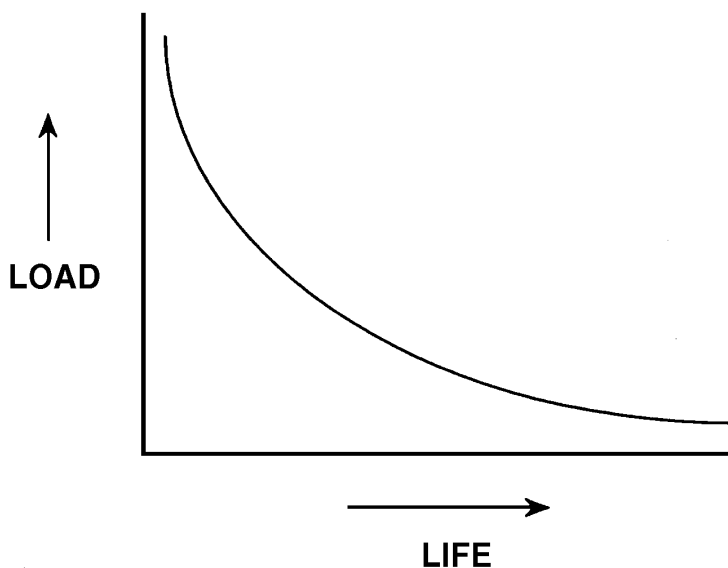

GENERAL APPLICATION GUIDELINES

Storage, Installation, and Maintenance

- Store switch in a clean, reasonably dry environment that does not exceed the rated temperature of the switch.
- Install the switch carefully:
 - ◆ Do not drill, sand or otherwise modify the switch.
 - ◆ Do not overtighten mounting screws. Review packing sheet instructions carefully.
 - ◆ If mounting the switch with an adhesive, use extreme care to avoid contaminating the switch interior.
 - ◆ Avoid the use of silicone materials to prevent silicone from coming in contact with the interior of the switch. If this is not possible, in low energy applications, use a sealed switch.
 - ◆ When soldering leads to terminals, use non-activated flux core solder and a soldering temperature of about 550° F (288° C).
 - ◆ Do not use solvents on switches.
 - ◆ Do not use commercial contact cleaners on snap-action switches.
 - ◆ Do not paint over switch after installation.
 - ◆ Do not connect opposite polarity between normally open and closed terminals. When this is done, and when the arc persists after the contacts are fully apart, a short circuit is established through the arc and hence through the switch.
- Chemicals used during maintenance cleaning can degrade switch materials. If the switch cannot be easily removed prior to cleaning and the types of chemicals used for cleaning are known, contact the MICRO SWITCH Application Center at 1-800- 537-6945 for fluid compatibility data.

Design

- For advice regarding the choice of a switch for a specific application, contact the MICRO SWITCH Application Center at 1-800-537-6945.
- If low price is an important factor, silver contacts may help reach the objective.
- All snap acting electromechanical switches have contact bounce. When the contact closes it bounces, causing the switch to open and close for a period of microseconds before staying closed. If contact bounce will be a problem, the circuit must be buffered. The circuit can be buffered with additional electronic circuitry or with software.
- If the load is below melting voltage, gold or gold alloys can be used for an added measure of safety.
- Actuate the switch as closely as possible to the extremes of its plunger travel without applying excess force that might damage the switch. For force data, contact the MICRO SWITCH Application Center, 1-800-537-6945.
- Decide, based on accurate technical information, whether a switch resistance specification is needed and whether its additional cost is justified. If so, on the basis of end use, specify: the voltage, current, plunger position, sequence of actuation, and measurement, and maximum allowable switch resistance.
- When to give switch resistance special attention:
 - ◆ When the switch controls a circuit at less than 0.5 volts.
 - ◆ When several switches must be connected in series.
 - ◆ When a switch is likely to be exposed to contaminating particles or fumes.
 - ◆ When an occasional switch closure with the switch resistance exceeding 1% of the load resistance will have negative consequences.
- Design the circuit so the switch sees voltage well above the softening voltage of the contact material, e.g., 0.08 volt for gold, 0.09 volt for silver.
- Design low voltage circuits with a minimum number of switches in series.
- Design the switch circuit to be as insensitive to normal variations of switch resistance as possible.

If additional assurance of low and stable resistance is desired, use bifurcated contacts or connect two or more switches in parallel and actuate them at the same time.

Customers should test the switch under conditions simulating end use to verify that it performs as required in the application.

Environment

- Protect unsealed switches from contamination by particles and fumes.
- Switches can be sealed to help prevent contamination from entering them. Some common levels of sealing are: dust resistant, drip-proof, water resistant, resilient, and hermetic. In general, the more critical the application and the harsher the environment, the more stringent the seal requirements.
- If the switch is unsealed and a low energy load is involved, a thorough understanding of the environment is required to choose the correct contact material and configuration. Contact the MICRO SWITCH Application Center at 1-800-537-6945, for help in choosing the proper material
- If the environment of an unsealed switch contains a significant amount of sulfides (such as decaying organic matter, cardboard, or vulcanized rubber) and moisture, gold or gold-plated contacts can help.
- If an alien film contaminant (such as paint spray or oil mist) can reach the contacts, gold won't help. Use a sealed switch.

SUMMARY

Contact material, contact configuration, and the degree of environmental protection are important considerations when low energy switching is required. They must be considered, along with other application variables, to determine the proper switch for the application. The most reliable and cost-effective solution to any switch application results from a partnership between the user and Honeywell's MICRO SWITCH Division.

For further technical information and assistance in determining your total switching requirements, contact MICRO SWITCH:

1-800-537-6945 USA
1-800-737-3360 Canada
1-815-235-6847 International

FAX

1-815-235-6545 USA

INTERNET

<http://www.sensing.honeywell.com>
info@micro.honeywell.com

Honeywell

MICRO SWITCH
Honeywell Inc.
11 West Spring Street
Freeport, Illinois 61032



Helping You Control Your World



SUNSTAR自动化 <http://www.sensor-ic.com/> TEL: 0755-83376489 FAX: 0755-83376182 E-MAIL: szss20@163.com