

## Cables

### For Force, Torque and Strain Sensors

Charge mode, high impedance piezoelectric measurement demands highly insulated coaxial cables and connectors to ensure an insulation resistance greater than  $10^{13} \Omega$  throughout the measuring chain. Only low noise coaxial cables that produce very little triboelectricity during movement may be used. The connectors must be robust, sealed and resistant to dirt.

Kistler connectors have been developed specifically to meet these requirements and are made of stainless steel. Unlike galvanized connectors they are therefore not subject to any wear, and measurement reliability and accuracy are improved. All Kistler connectors contain an O-ring seal at the cable end and the connection end.

Most Kistler sensors have a connection with a KIAG 10-32 or M4 male thread. Connectors with a swivel nut and versions with an integral thread are available for both variants. The one-piece body of the connectors with an integral thread can be welded to the sensor in order to ensure that, for example when the sensor is firmly mounted, the screw connection cannot work loose. For the connection of connectors with an integral thread, cable and sensor must be able to rotate freely in relation to each other.

The selection chart shown on page 2 specifies the type numbers of the most commonly used connecting cables for force, torque and strain sensors. The individual types with available lengths are described on the following pages. The details of multiconductor and special application connecting cables may be found on the corresponding sensor data sheets. The abbreviation pos. stands for male and neg. for female connectors.

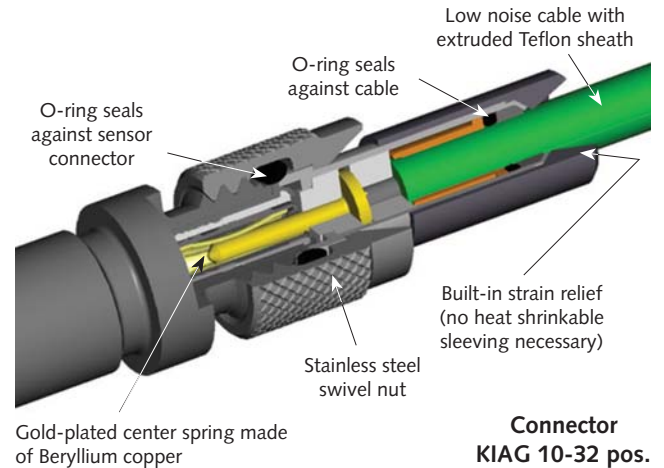

Fig. 1: Connector with swivel nut

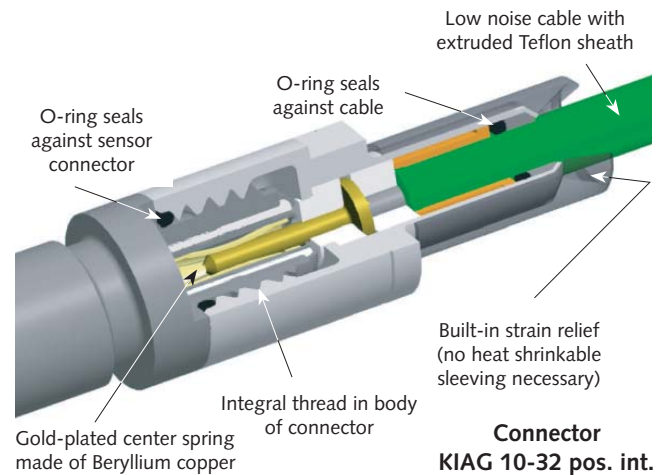

Fig. 2: Connector with integral thread

1631C\_000-346e-06.11

### Selection Chart for Connecting Cables

M4x0,35 pos.	M4x0,35 pos. int.	M4x0,35 pos. int. with pull-out thread M5	KIAG 10-32 pos.	KIAG 10-32 pos. int.	TNC pos.	
						M4x0,35 pos. int. 
<b>1655C...</b>			<b>1635C...</b> <b>1957A...</b>			KIAG 10-32 pos. 
	<b>1951A...</b> <b>1983AB...</b>			<b>1967A...</b> <b>1969A...</b> <b>1983AC...</b>		KIAG 10-32 pos. int. 
				<b>1943A...</b> <b>1945A...</b>		Mini-Coax neg. 
<b>1651C...</b>	<b>1923A...</b>		<b>1631C...</b> <b>1641B...</b>	<b>1939A...</b> <b>1983AD...</b>	<b>1609B...</b> <b>1610A...</b> <b>1619B...</b>	BNC pos. 
			<b>1633C...</b>	<b>1941A...</b>		TNC pos. 
		<b>1645C...</b>				Fischer Coax neg. KE 102A014-14 
				<b>1979A...</b>		Fischer Triax neg. KE 103A015-12 

### Selection Chart for Extension Cables

KIAG 10-32 neg.	Mini-Coax pos.	BNC neg.	BNC pos.	TNC pos.	
					KIAG 10-32 pos. 
<b>1637C...</b>					BNC pos. 
	<b>1937A...</b>	<b>1603B...</b>	<b>1601B...</b>		TNC pos. 
				<b>1615B...</b>	

1631C\_000-346e-06.11

**Type 1601B... Connecting Cable BNC**

Length (m) 0,5/1/2/5/10/20/sp ( $L_{min} = 0,1 \text{ m}/L_{max} = 50 \text{ m}$ )  
 Temperature range  $-25 \dots 70 \text{ }^\circ\text{C}$   
 Smallest possible bending radius 10 mm

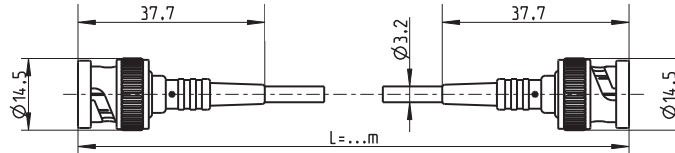

Cable plug BNC pos.  
 Degree of protection (EN60529) IP40  
 Cable PVC black  $\varnothing 3,2 \text{ mm}$   
 BNC pos. IP40

**Type 1603B... Extension Cable BNC**

Length (m) 2/5/10/20/50/sp ( $L_{min} = 0,1 \text{ m}/L_{max} = 50 \text{ m}$ )  
 Temperature range  $-25 \dots 70 \text{ }^\circ\text{C}$   
 Smallest possible bending radius 10 mm

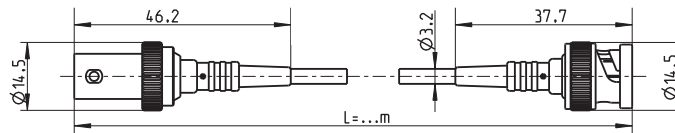

Cable plug BNC neg.  
 Degree of protection (EN60529) IP40  
 Cable PVC black  $\varnothing 3,2 \text{ mm}$   
 BNC pos. IP40

**Type 1609B... Connecting Cable for Sensors with TNC neg. Connector**

Length (m) 2/5/10/20/50/sp ( $L_{min} = 0,1 \text{ m}/L_{max} = 50 \text{ m}$ )  
 Temperature range  $-25 \dots 70 \text{ }^\circ\text{C}$   
 Smallest possible bending radius 10 mm

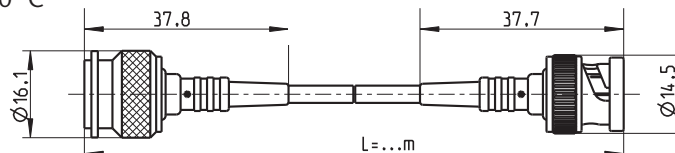

Cable plug TNC pos.  
 Degree of protection (EN60529) IP65  
 Cable PVC black  $\varnothing 3,2 \text{ mm}$   
 BNC pos. IP40

**Type 1610A... Connecting Cable for Sensors with TNC neg. Connector**

Length (m) 2/5/10/sp ( $L_{min} = 0,1 \text{ m}/L_{max} = 20 \text{ m}$ )  
 Temperature range  $-55 \dots 200 \text{ }^\circ\text{C}$   
 Smallest possible bending radius 5 mm

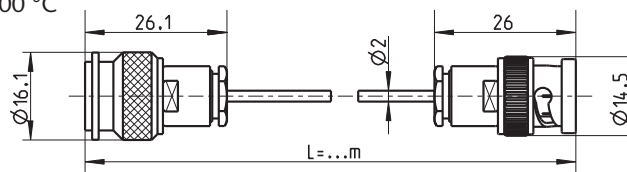

Cable plug TNC pos.  
 Degree of protection (EN60529) IP65  
 Cable PFA green  $\varnothing 2 \text{ mm}$   
 BNC pos. IP40

1631C\_000-346e-06.11

**Type 1615B... Connecting Cable TNC Armored**

Length (m) 5/sp ( $L_{min} = 1$  m/ $L_{max} = 10$  m)  
 Temperature range -25 ... 70 °C  
 Smallest possible bending radius 5 mm

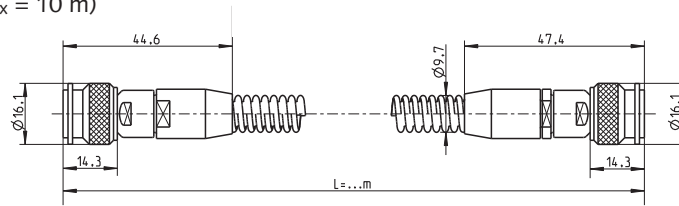

Cable plug TNC pos. Cable PVC black TNC pos.  
 Degree of protection (EN60529) IP65 with flexible stainless steel hose  $\varnothing 9,7$  mm IP65

**Type 1619B... Connecting Cable Armored for Sensors with TNC neg. Connector**

Length (m) 5/10/sp ( $L_{min} = 1$  m/ $L_{max} = 20$  m)  
 Temperature range -25 ... 70 °C  
 Smallest possible bending radius 5 mm

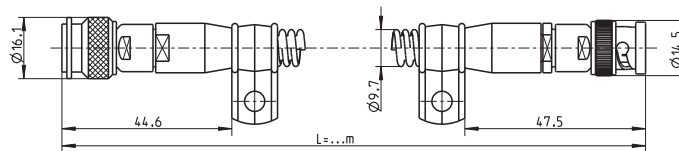

Cable plug TNC pos. Cable PVC black BNC pos.  
 Degree of protection (EN60529) IP65 with flexible stainless steel hose  $\varnothing 9,7$  mm IP40

**Type 1631C... Connecting Cable for Sensors with KIAG 10-32 neg. Connector**

Length (m) 0,5/1/2/3/5/10/20/sp ( $L_{min} = 0,1$  m/ $L_{max} = 50$  m)  
 Temperature range -55 ... 200 °C  
 Smallest possible bending radius 5 mm

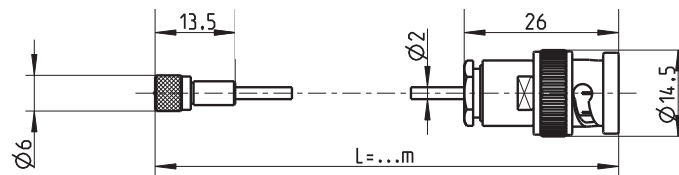

Cable plug KIAG 10-32 pos. Cable PFA green  $\varnothing 2$  mm BNC pos.  
 Degree of protection (EN60529) IP65 IP40

**Type 1633C... Connecting Cable for Sensors with KIAG 10-32 neg. Connector**

Length (m) 0,5/1/2/5/sp ( $L_{min} = 0,1$  m/ $L_{max} = 50$  m)  
 Temperature range -55 ... 200 °C  
 Smallest possible bending radius 5 mm

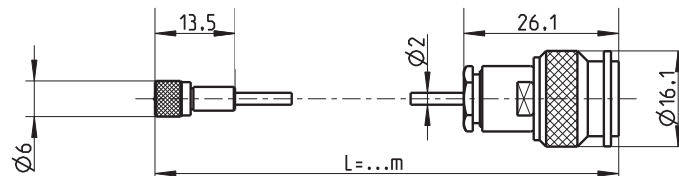

Cable plug KIAG 10-32 pos. Cable PFA green  $\varnothing 2$  mm TNC pos. 1813  
 Degree of protection (EN60529) IP65 IP65

1631C\_000-346e-06.11

**Type 1635C... Connecting Cable for Sensors with KIAG 10-32 neg. Connector**

Length (m) 0,5/1/2/5/10/sp ( $L_{min} = 0,1$  m/ $L_{max} = 15$  m)  
 Temperature range -55 ... 200 °C  
 Smallest possible bending radius 5 mm

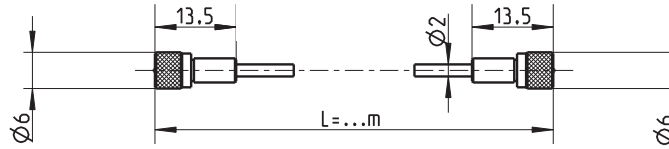

Cable plug KIAG 10-32 pos. Cable PFA green Ø2 mm KIAG 10-32 pos.  
 Degree of protection (EN60529) IP65 IP65

**Type 1637C... Extension Cable KIAG 10-32**

Length (m) 5/sp ( $L_{min} = 0,3$  m/ $L_{max} = 5$  m)  
 Temperature range -55 ... 200 °C  
 Smallest possible bending radius 5 mm

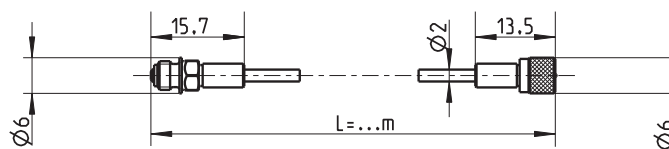

Cable plug KIAG 10-32 neg. Cable PFA green Ø2 mm KIAG 10-32 pos.  
 Degree of protection (EN60529) IP65 IP65

**Type 1641B... Connecting Cable for Sensors with KIAG 10-32 neg. Connector**

Length (m) 0,5/1/2/5/sp ( $L_{min} = 0,1$  m/ $L_{max} = 50$  m)  
 Temperature range -55 ... 200 °C  
 Smallest possible bending radius 5 mm

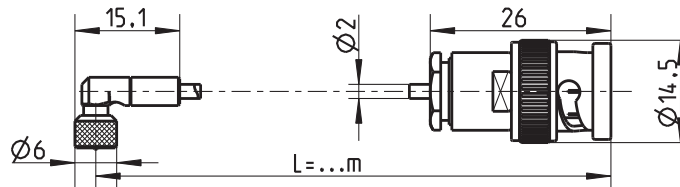

Cable plug KIAG 10-32 pos. (90°) Cable PFA green Ø2 mm BNC pos.  
 Degree of protection (EN60529) IP65 IP40

**Type 1645C... Connecting Cable for Sensors with M4x0,35 neg. Connector, Connector with M5 Pull-Out Thread**

Length (m) 0,2/0,4/0,6/0,8/sp ( $L_{min} = 0,1$  m/ $L_{max} = 5$  m)  
 Temperature range -55 ... 200 °C  
 Smallest possible bending radius 5 mm

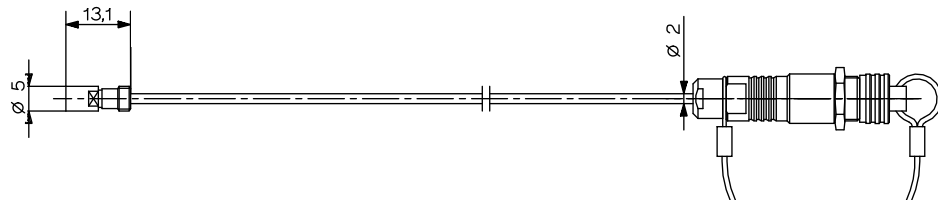

Cable plug M4x0,35 pos. int. Cable PFA green Ø2 mm Fischer Coax neg. KE 102A014-14  
 Degree of protection (EN60529) IP65 IP65

1631C\_000-346e-06.11

**Type 1651C... Connecting Cable for Sensors with M4x0,35 neg. Connector**

Length (m) 0,5/1/2/5/10/sp ( $L_{min} = 0,3$  m/ $L_{max} = 10$  m)  
 Temperature range -55 ... 200 °C  
 Smallest possible bending radius 5 mm

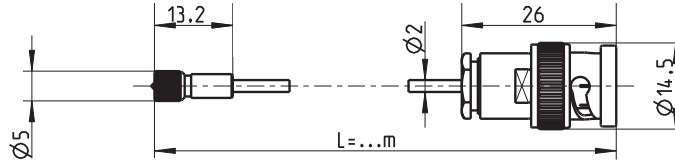

Cable plug M4x0,35 pos. Cable PFA green  $\varnothing$  2 mm BNC pos.  
 Degree of protection (EN60529) IP65 IP40

**Type 1655C... Connecting Cable for Sensors with M4x0,35 neg. Connector**

Length (m) 1/2/sp ( $L_{min} = 0,3$  m/ $L_{max} = 10$  m)  
 Temperature range -55 ... 200 °C  
 Smallest possible bending radius 5 mm

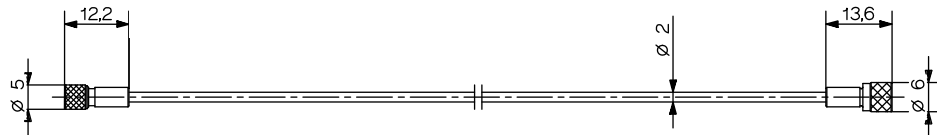

Cable plug M4x0,35 pos. Cable PFA green  $\varnothing$ 2 mm KIAG 10-32 pos.  
 Degree of protection (EN60529) IP65 IP65

**Type 1923A... Connecting Cable for Sensors with M4x0,35 neg. Connector**

Length (m) 1/sp ( $L_{min} = 0,1$  m/ $L_{max} = 5$  m)  
 Temperature range -55 ... 200 °C  
 Smallest possible bending radius 5 mm

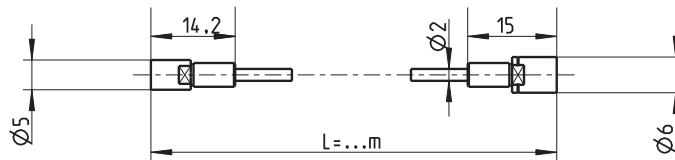

Cable plug M4x0,35 pos. int. Cable PFA green  $\varnothing$ 2 mm KIAG 10-32 pos. int.  
 Degree of protection (EN60529) IP65 IP65

**Type 1926A... Connecting Cable for Sensors with M4x0,35 neg. Connector**

Length (m) 0,8/sp ( $L_{min} = 0,1$  m/ $L_{max} = 10$  m)  
 Temperature range -55 ... 200 °C  
 Smallest possible bending radius 5 mm



Cable plug M4x0,35 pos. int. Cable PFA green  $\varnothing$ 2 mm M4x0,35 pos.  
 Degree of protection (EN60529) IP65 IP65

1631C\_000-346e-06.11

**Type 1937A... Connecting and Test Cable, Mini Coax**

Length (m) 1/sp ( $L_{min} = 0,1$  m/ $L_{max} = 10$  m)  
 Temperature range  $-55 \dots 200$  °C  
 Smallest possible bending radius 5 mm

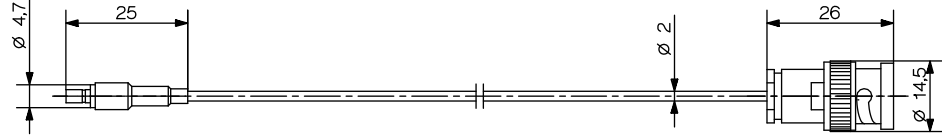

Cable plug Mini-Coax pos. Cable PFA green  $\varnothing 2$  mm BNC pos.  
 Degree of protection (EN60529) IP40 IP40

**Type 1939A... Connecting Cable for Sensors with KIAG 10-32 neg. Connector**

Length (m) 1/2/3/sp ( $L_{min} = 0,1$  m/ $L_{max} = 20$  m)  
 Temperature range  $-55 \dots 200$  °C  
 Smallest possible bending radius 5 mm

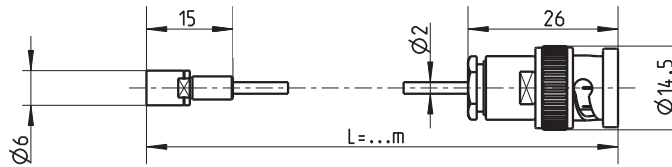

Cable plug KIAG 10-32 pos. int. Cable PFA green  $\varnothing 2$  mm BNC pos.  
 Degree of protection (EN60529) IP65 IP40

**Type 1941A... Connecting Cable for Sensors with KIAG 10-32 neg. Connector**

Length (m) 1/2/3/sp ( $L_{min} = 0,1$  m/ $L_{max} = 20$  m)  
 Temperature range  $-55 \dots 200$  °C  
 Smallest possible bending radius 5 mm

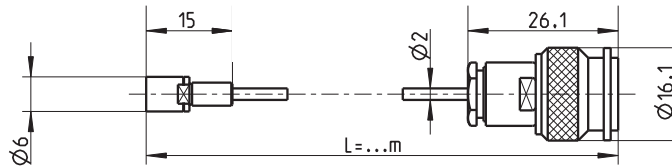

Cable plug KIAG 10-32 pos. int. Cable PFA green  $\varnothing 2$  mm TNC pos.  
 Degree of protection (EN60529) IP65 IP65

**Type 1943A... Connecting Cable for Sensors with KIAG 10-32 neg. Connector**

Length (m) 1/2/3/sp ( $L_{min} = 0,1$  m/ $L_{max} = 10$  m)  
 Temperature range  $-55 \dots 200$  °C  
 Smallest possible bending radius 5 mm

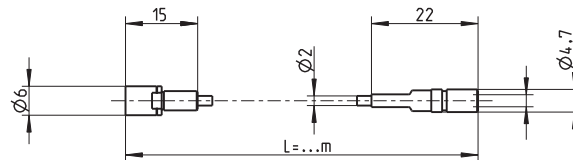

Cable plug KIAG 10-32 pos. int. Cable PFA green  $\varnothing 2$  mm Mini-Coax neg.  
 Degree of protection (EN60529) IP65 IP40

1631C\_000-346e-06.11



**Type 1945A... Connecting Cable for Sensors with KIAG 10-32 neg. Connector**

The fact that this cable is very thin makes it highly suitable for use in molds.

Length (m) 1/2/sp ( $L_{min} = 0,1 \text{ m} / L_{max} = 5 \text{ m}$ )  
 Temperature range  $-55 \dots 200 \text{ }^\circ\text{C}$   
 Smallest possible bending radius 3 mm

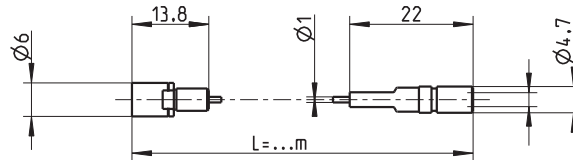

Cable plug KIAG 10-32 pos. int. Cable PFA blue  $\varnothing 1 \text{ mm}$  Mini-Coax neg.  
 Degree of protection (EN60529) IP65 IP65 IP40

**Type 1951A... High Temperature Connecting Cable for Sensors with M4x0,35 neg. Connector**

Length (m) 0,4/sp ( $L_{min} = 0,1 \text{ m} / L_{max} = 5 \text{ m}$ )  
 Temperature range  $-55 \dots 300 \text{ }^\circ\text{C}$   
 Smallest possible bending radius 8 mm

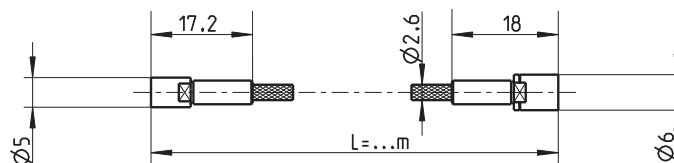

Cable plug M4x0,35 pos. int. Cable Kapton® with stainless steel sheathed  $\varnothing 2,6 \text{ mm}$  KIAG 10-32 pos. int.  
 Degree of protection (EN60529) IP65 IP65 IP65

**Type 1957A... Connecting Cable for Sensors with KIAG 10-32 neg. Connector**

Length (m) 1/sp ( $L_{min} = 0,1 \text{ m} / L_{max} = 10 \text{ m}$ )  
 Temperature range  $-55 \dots 200 \text{ }^\circ\text{C}$   
 Smallest possible bending radius 10 mm

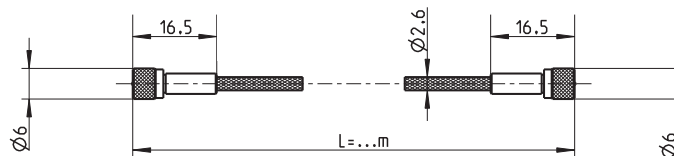

Cable plug KIAG 10-32 pos. Cable PFA green KIAG 10-32 pos.  
 Degree of protection (EN60529) IP65 with stainless steel sheathed  $\varnothing 2,6 \text{ mm}$  IP65

**Type 1967A... Connecting Cable for Sensors with KIAG 10-32 neg. Connector**

Length (m) 1/sp ( $L_{min} = 0,5 \text{ m} / L_{max} = 10 \text{ m}$ )  
 Temperature range  $-55 \dots 200 \text{ }^\circ\text{C}$   
 Smallest possible bending radius 10 mm

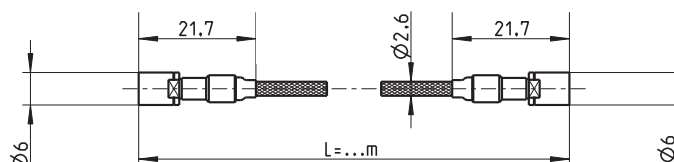

Cable plug KIAG 10-32 pos. int. Cable PFA green KIAG 10-32 pos. int.  
 Degree of protection (EN60529) IP65 ground-isolated, stainless steel sheathed  $\varnothing 2,6 \text{ mm}$  IP65

1631C\_000-346e-06.11



**Type 1969A... Connecting Cable for Sensors with KIAG 10-32 neg. Connector**

Length (m) 1/sp ( $L_{min} = 0,5$  m/ $L_{max} = 10$  m)  
 Temperature range  $-55 \dots 200$  °C  
 Smallest possible bending radius 10 mm

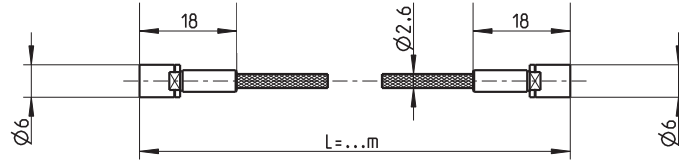

Cable plug KIAG 10-32 pos. int. Cable PFA green KIAG 10-32 pos. int.  
 Degree of protection (EN60529) IP65 with stainless steel sheathed  $\varnothing 2,6$  mm IP65

**Type 1979A... Connecting Cable for Sensors with KIAG 10-32 neg. Connector, incl. Clamping Angle for Cable Coupling**

Length (m) 1/sp ( $L_{min} = 0,1$  m/ $L_{max} = 20$  m)  
 Temperature range  $-55 \dots 200$  °C  
 Smallest possible bending radius 13,2 mm

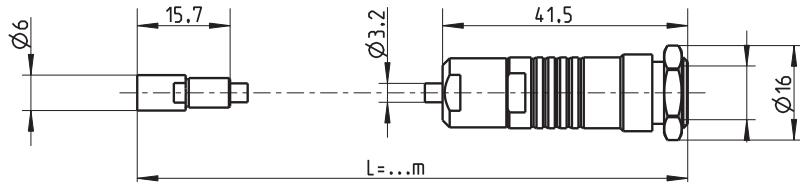

Cable plug KIAG 10-32 pos. int. Cable Viton®  $\varnothing 3,2$  mm Fischer Triax neg. KE 103A015-12  
 Degree of protection (EN60529) IP65 IP65

**Type 1983AB... Connecting Cable for Sensors with M4x0,35 neg. Connector**

With protective cap vulcanized to the cable at the sensor end. Welding the connection provides a permanent seal. Suitable for use in the vicinity of oils, emulsions, cooling lubricants, etc.

Length (m) 0,5/1/1,5/2/3/5  
 Temperature range  $-55 \dots 200$  °C  
 Smallest possible bending radius 5 mm

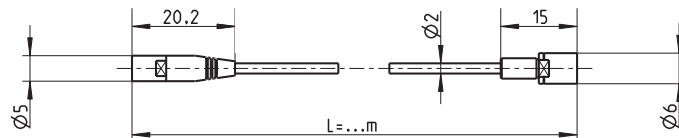

Cable plug M4x0,35 pos. int. Cable Viton®  $\varnothing 2$  mm KIAG 10-32 pos. int.  
 Degree of protection (EN60529) IP65 connection screwed IP67 connection welded IP65

1631C\_000-346e-06.11

**Type 1983AC... Connecting Cable for Sensors with KIAG 10-32 neg. Connector**

With protective cap vulcanized to the cable at the sensor end. Welding the connection provides a permanent seal. Suitable for use in the vicinity of oils, emulsions, cooling lubricants, etc.

Length (m) 0,5/1/1,5/2/3  
 Temperature range -55 ... 200 °C  
 Smallest possible bending radius 5 mm

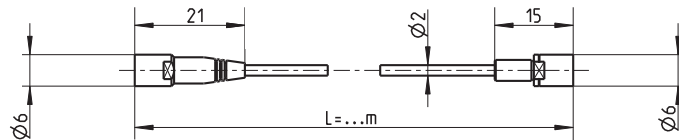

Cable plug	KIAG 10-32 pos. int.	Cable Viton® ø2 mm	KIAG 10-32 pos. int.
Degree of protection (EN60529)	IP65 connection screwed IP67 connection welded		IP65

**Type 1983AD... Connecting Cable for Sensors with KIAG 10-32 neg. Connector**

With protective cap vulcanized to the cable at the sensor end. Welding the connection provides a permanent seal. Suitable for use in the vicinity of oils, emulsions, cooling lubricants, etc.

Length (m) 2/5/sp (L<sub>min</sub> = 0,1 m/L<sub>max</sub> = 5 m)  
 Temperature range -55 ... 200 °C  
 Smallest possible bending radius 5 mm

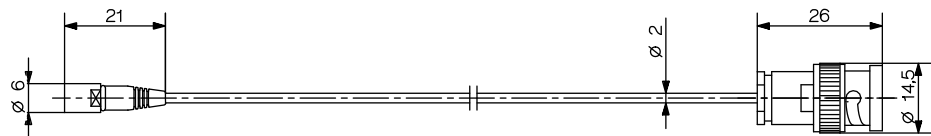

Cable plug	KIAG 10-32 pos. int.	Cable Viton® ø2 mm	BNC pos.
Degree of protection (EN60529)	IP65 connection screwed IP67 connection welded		IP40

1631C\_000-346e-06.11

**Cable Koaxial      Technical Data**

**PFA blue**                      **ø1,0 mm**  
 Temperature range      -55 ... 200 °C  
 Capacitance                      94 pF/m  
 Smallest possible  
 bending radius              3 mm



Construction                      Silver-plated copper alloy center conductor (1), PTFE dielectric (2) with semiconducting coating (3), silver-plated copper wire braid (4) and blue PFA sheath (5).

**PFA green**                      **ø2,0 mm**  
 Temperature range      -55 ... 200 °C  
 Capacitance                      96 pF/m  
 Smallest possible  
 bending radius              5 mm



Construction                      Copper- and silver-plated steel wire center conductor (1), PTFE dielectric (2) with semiconducting coating (3), silver-plated copper wire braid (4) and extruded green PFA sheath (5).

**PFA green**                      **with Stainless Steel Sheathing, ø2,6 mm**  
 Temperature range      -55 ... 200 °C  
 Capacitance                      100 pF/m  
 Smallest possible  
 bending radius              10 mm



Construction                      Copper- and silver-plated steel wire center conductor (1), PTFE dielectric (2) with semiconducting coating (3), silver-plated copper wire braid (4) and extruded green PFA sheath with stainless steel outer sheath (6).

**Kapton®**                      **with Stainless Steel Sheathing, ø2,6 mm**  
 Temperature range      -55 ... 300 °C  
 Capacitance                      105 pF/m  
 Smallest possible  
 bending radius              10 mm



Construction                      Nickel-plated copper wire center conductor (1), PI dielectric (2) wrapped with semiconducting tape (3), nickel-plated copper braid (4) and PI sheath (5) with stainless steel outer sheath (6).

1631C\_000-346e-06.11

**Cable Koaxial      Technical Data**

**Viton®**                    **ø2,0 mm**  
 Temperature range    -90 ... 200 °C  
 Capacitance            107 pF/m  
 Smallest possible     5 mm  
 bending radius



Construction            Silver-plated steel wire center conductor (1), extruded PTFE dielectric (2) with semiconducting coating (3), silver-plated copper wire braid (4) and oil-resistant FPM sheath (5).

**Viton®**                    **ø3,2 mm**  
 Temperature range    -90 ... 200 °C  
 Capacitance            100 pF/m  
 Smallest possible     10 mm  
 bending radius



Construction            Silver-plated steel wire center conductor (1), extruded PTFE dielectric (2) with semiconducting coating (3), silver-plated copper wire braid (4) and oil-resistant FPM sheath (5).

**PVC black**                **ø3,2 mm**  
 Temperature range    -25 ... 70 °C  
 Capacitance            100 pF/m  
 Smallest possible     10 mm  
 bending radius



Construction            Bare copper wire center conductor (1), polyethylene dielectric (2), PVC semiconductor (3), bare copper wire braid (4) and black PVC sheath (5).

**Acronyms**

FPM                      Fluoroelastomer (Viton®)  
 PFA                      Perfluoroalkoxy copolymer  
 PI                        Polyimide (Kapton®)  
 PTFE                    Polytetrafluoroethylene  
 PVC                      Polyvinyl chloride

Viton® is a registered Trademark of DuPont Performance Elastomers.  
 Kapton® is a registered Trademark of DuPont.

1631C\_000-346e-06.11

**General Notes**

**Insulation Resistance** During final inspection all cables and lengths are tested to ensure their insulation resistance exceeds  $\geq 10^{14} \Omega$ .

**Protective Caps** All connectors are supplied with protective caps to prevent ingress of moisture and dirt. It is advisable to always replace the cap when the cable is not in use.

**Degree of Protection** The IP degree of protection to EN60529 is tested with water. As oils, emulsions, cooling lubricants, etc, usually have a higher wetting and penetration capability, the degree of protection in contact with such fluids must be classified as being correspondingly lower.

**Bending Radius** The smallest permissible bending radius of coaxial cables depends on the application. The specified value relates to the connecting cable for a firmly mounted sensor being bent once only. For repeated bending the values must be at least doubled, and for flexible use and/or low-temperature applications trebled or more.

**Length Tolerance**

Cable length L (m)	Tolerance +.../-0 mm
<0,5	10
>0,5 ... 1,0	20
>1,0 ... 5,0	50
>5,0 ... 10,0	100
>10,0 ... 20,0	150
>20,0 ... 30,0	200
>30,0 ... 50,0	500
>50,0 ... 75,0	750
>75,0 ... 100,0	1 000

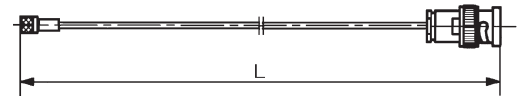

**Marking**

The type number and the length of the cable are specified on the pack. The detachable part of the label can be folded and used to mark the cable.

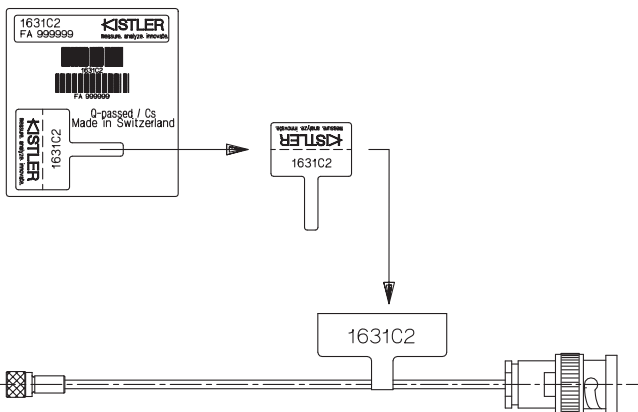

**Ordering Key**

**Length**

L = x standard length in m

Type 1631C

**Length**

L = sp  
(specify special length in order)

Type 1957Asp

The standard lengths of a particular type available and the range of possible special lengths are listed in the relevant section.

1631C\_000-346e-06.11