

# DAQ-System for DynoWare

Type 5697A...

## Data Acquisition System for Force Measurement

Data acquisition system for interfacing and controlling charge amplifiers and signal conditioners in general and cutting force applications using one or more component sensors and dynamometers. The system is connected via a USB 2.0 port and is controlled by the DynoWare program.

- Easy to install using USB 2.0 port
- Remote control of charge amplifier
- Powerful data acquisition system
- High sampling rate
- Trigger function

### Description

The DAQ system for DynoWare consists of a connection box and the DynoWare program. Up to two multichannel charge amplifiers, and hence two measuring chains, can be connected to the connection box.<sup>1)</sup> A 16-bit A/D converter digitizes the analog output data. The system is connected to the PC via a USB 2.0 port, control of the charge amplifier or signal conditioner is handled by the connection box via an RS-232C cable. Users have at their disposal an easy-to-use data acquisition system with a high sampling rate.

### Application

Type 5697A... DAQ system has been developed specifically for piezoelectric measuring systems and their charge amplifiers and signal conditioners. The excellent resolution of the system and its very high sampling frequency of up to 125 kS/s with 8 measuring channels enables customers to measure highly-dynamic processes and covers a very broad range of applications. When used in conjunction with the DynoWare package, the DAQ system comes into its own in general measuring and cutting force measurement applications.



### Technical Data

#### General Data

Dimensions	mm	208x70x249
Weight	kg	2,15
Operating temperature range	°C	0 ... 50
Min./max. temperature	°C	-10/60

#### Power Supply

Galvanic isolation (max. 40 V) between input voltage and supply voltage

Input voltage range	VDC	10 ... 36
Consumption	VA	≈5

#### A/D Conversion

Number of channels		28 <sup>1)</sup>
Resolution (per channel)	Bit	16
Input voltage ranges (configured through software)	V	±0,1/±0,2/±0,5 ±1/±2/±5/±10
Input voltage	V	max. ±20
Sampling frequency (configured through software)	kS/s	... 1 000
max. @ 1 channel	kS/s	1 000
max. @ 3 channels	kS/s	333
max. @ 8 channels	kS/s	125
max. @ 14 channels	kS/s	71

#### Interfaces

USB 2.0 (high-speed)		
USB In (uplink, to PC)	Type	B, female
USB Out (for HASP licence key)	Type	A, female

<sup>1)</sup> DynoWare Type 2825A and DynoWare Update Type 2825E currently only support the control of one multichannel charge amplifier on the connection box. A maximum of 28 channels can be acquired.

### Remote Control

(Digital input and 12 V supply)

Remote measure and trigger with 10 kΩ pullup to +5 V

Connector type		D-Sub 9f
Input level		
High (/Trigger Input/Measure Input)	VDC	<1,5
Low	VDC	<1
Supply	VDC	+12

Complies with EU Directive 200/108/EU and the EMC standards:  
 EN 61000-6-4 emitted interference, EN610006-2 noise immunity,  
 Product standards EN 61326-1 (class A+B)  
 EN60950-1 Safety (plug-in power supply)

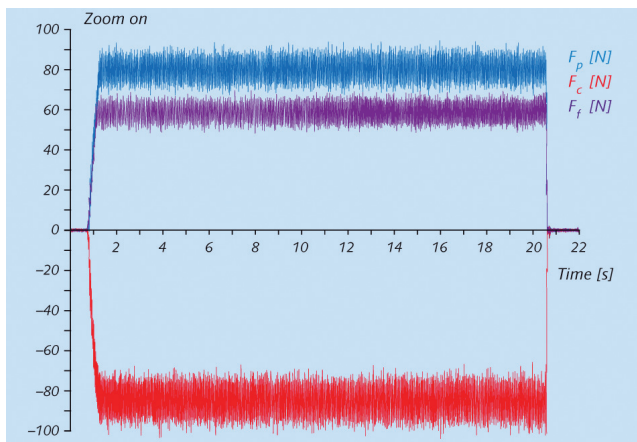

Fig. 1: Turning measuring data, captured by DynoWare

### DynoWare

DynoWare is the software program behind the measuring system. It captures the signals from the sensors and dynamometers, converts them into readable information and outputs the results in a presentable format. DynoWare is able to control charge amplifiers or signal conditioners remotely.

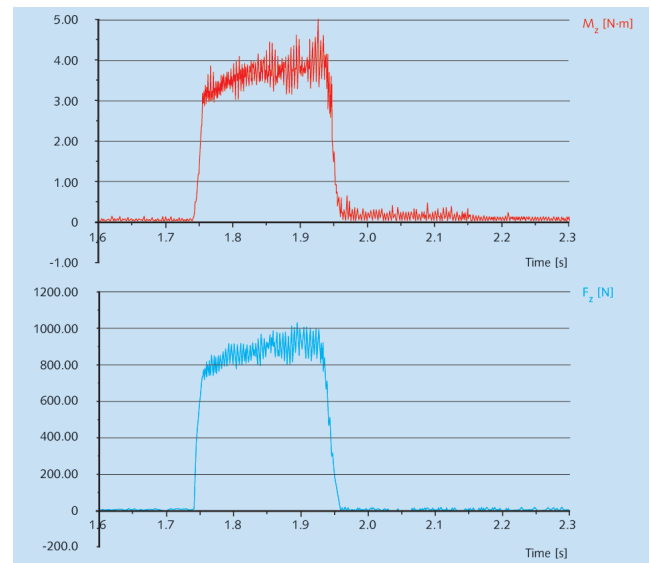

Fig. 3: Drilling measuring data, captured by DynoWare

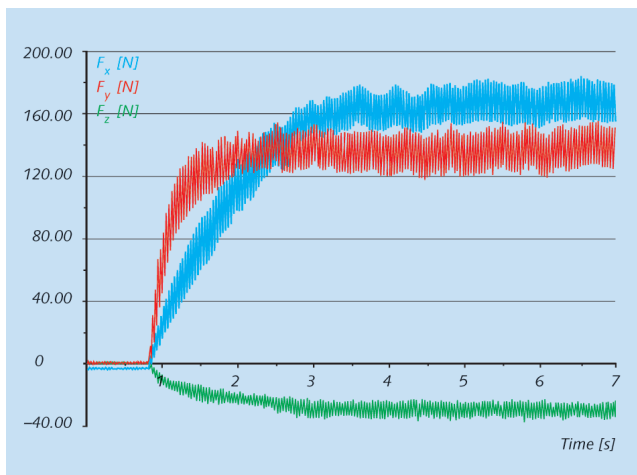

Fig. 2: Milling measuring data, captured by DynoWare

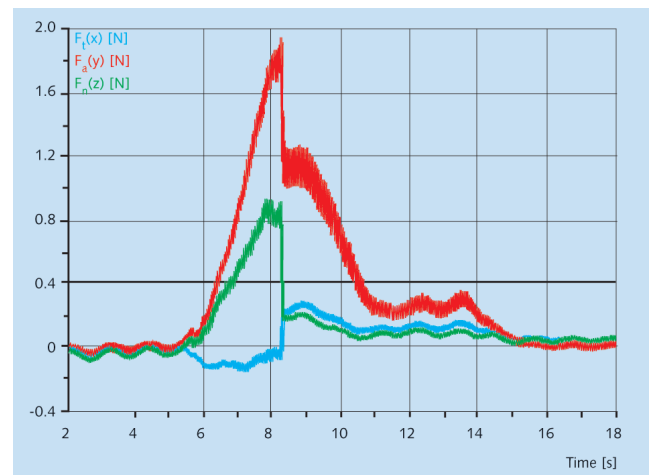

Fig. 4: Grinding disk breakage when grinding, measuring data captured by DynoWare

5697A\_000-745e-05.12

**Dimensions**

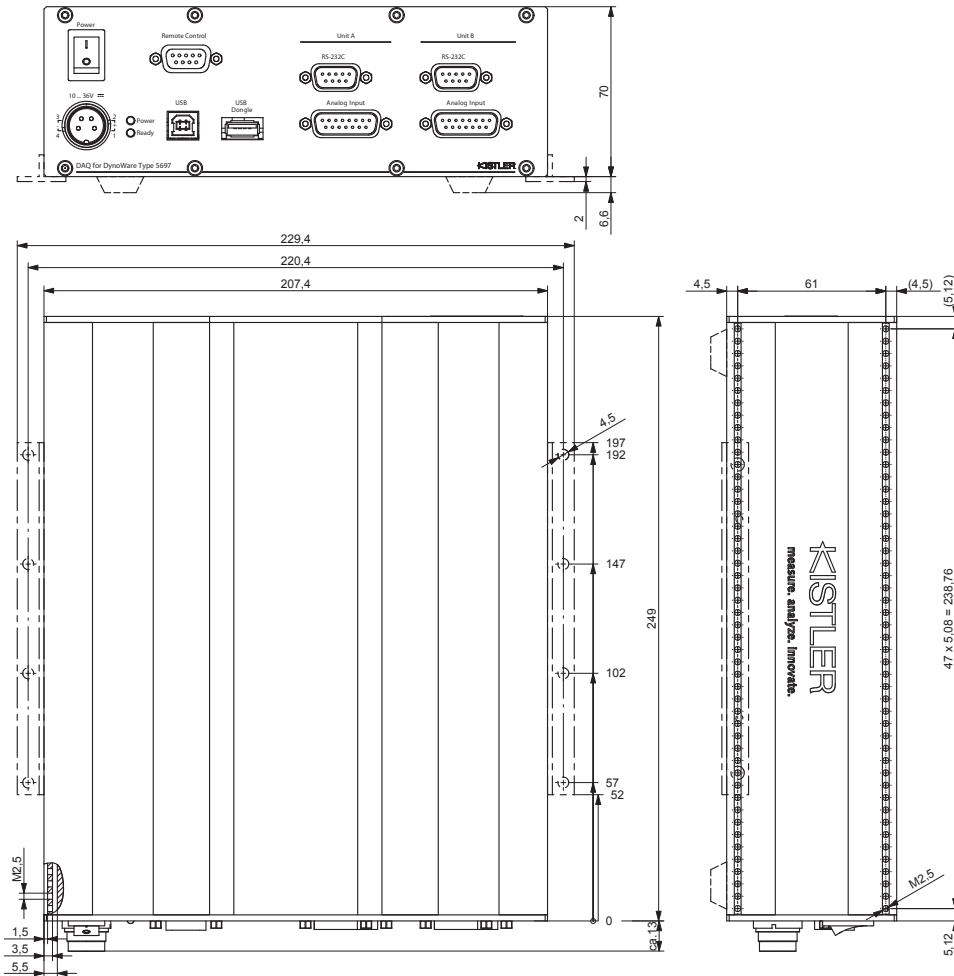

Fig. 5: Dimensions Type 5697A

**Typical Measuring Chain with DAQ-System Type 5697A1**

Dynamometer	Connecting cable, high resistant	Charge amplifier	Connecting cable	DAQ system	Notebook (customer) with DynoWare
Type 9129AA	Type 1677A5	Type 5070A	Type 1700A111A2 Type 1200A27	Type 5697A1	

5697A\_000-745e-05.12

**Cable Concept for DynoWare Type 2825A... with DAQ-System Typ 5697A**

**Connecting Cable for Measuring Signal**

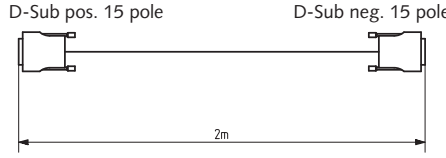
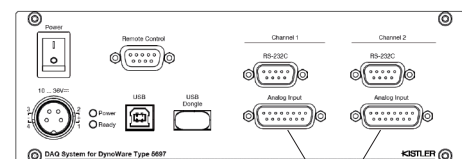
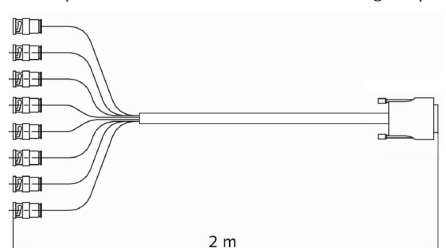
Signal Conditioner	Measuring Signal Connecting Cable	A/D Acquisition Card
Type 5017... 5019... 5070... 5080... 5223... 5237...	Type 1700A111A2 D-Sub pos. 15 pole      D-Sub neg. 15 pole 	Type 5697A  D-Sub pos. 15 pole
Type 5011... 5015... 5017... 5018... 5019... 5080... 5223... 5237... other products	Type 1700A113A2 8x BNC pos.      D-Sub neg. 15 pole 	

**Interface Cables**

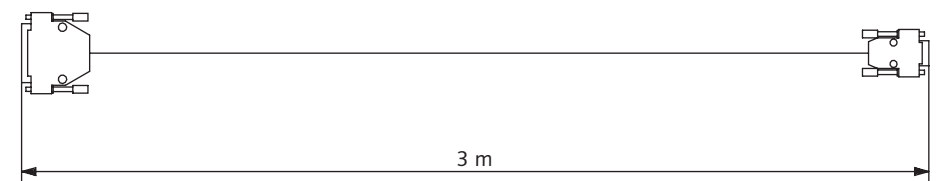
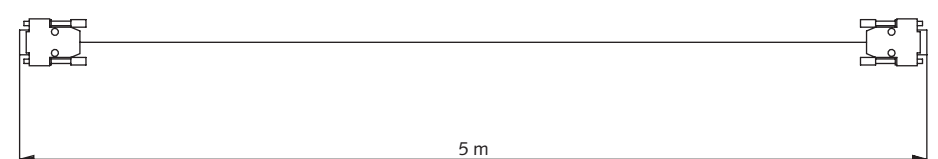
Signal Conditioner	RS-232C Interface Cable (Null Modem)
Type 5011Bx2 5017... 5019... 5223...	Type 1475A3 D-Sub pos. 25 pole      D-Sub neg. 9 pole 
Type 5015... 5018... 5070... 5080... 5237...	Type 1200A27 D-Sub pos. 9 pole      D-Sub neg. 9 pole 

5697A\_000-745e-05.12

### Analog Input

Pin	Function
1	Analog Channel 1
2	Analog Channel 2
3	Analog Channel 3
4	Analog Channel 4
5	Analog Channel 5
6	Analog Channel 6
7	Analog Channel 7
8	Analog Channel 8

Pin	Function
9	Analog GND
10	Analog Channel 9
11	Analog Channel 10
12	Analog Channel 11
13	Analog Channel 12
14	Analog Channel 13
15	Analog Channel 14

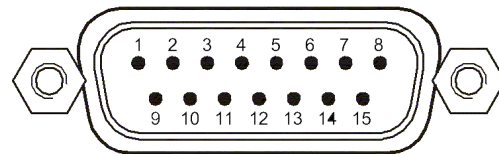

Fig. 6: 15 pole, male

### RS-232C

Pin	Function
1	n.c.
2	RxD
3	TxD
4	n.c.
5	GND

Pin	Function
6	n.c.
7	n.c.
8	n.c.
9	n.c.

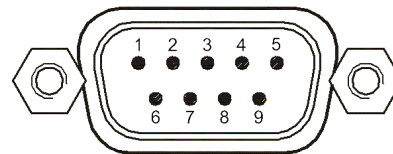

Fig 7: 9 pole, male

### Remote Control

Pin	Function
1	+12 VDC
2	GND
3	n.c.
4	/Trigger
5	/Measure

Pin	Function
6	GND
7	n.c.
8	n.c.
9	n.c.

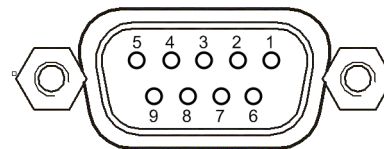

Fig. 8: 9 pole, female

### Power 10 ... 36 VDC

Pin	Function
1	10 ... 36 VDC
2	GND
3	GND
4	10 ... 36 VDC

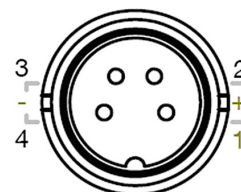

Fig. 9: M12, 4 pole, male

5697A\_000-745e-05.12

**System Requirements for DynoWare**

- Microsoft Windows® XP, Vista, Windows® 7 (32-bit/64-bit)
- At least 512 MB RAM
- At least 100 MB free disk space
- Adobe® Acrobat® Reader®
- Free USB 2.0 port

**Included Accessories**

**for Type 5697A1**

- USB 2.0 cable, l = 1,8 m
- Power supply unit, 100 ... 240 V~, 24 VDC/24 W
- DynoWare Software CD-ROM Full licence with HASP licence key
- Instruction Manual

**Type/Art. No.**

- 5.590.303
- 5.510.347
- 2825A-02-2
- 2825A\_002-195

**for Type 5697A2**

- USB 2.0 cable, l = 1,8 m
- Power supply unit, 100 ... 240 V~, 24 VDC/24 W
- DynoWare Software CD-ROM Update without HASP licence key
- Instruction Manual

**Type/Art. No.**

- 5.590.303
- 5.510.347
- 2825E-02-0
- 2825A\_002-195

**Optional Accessories**

- RS-232C cable, l = 5 m, null modem, DB-9P/DB-9S <sup>1)</sup> 1200A27
- or PC-Link cable RS-232C, l = 3 m, DB-25P/DB-9S <sup>1)</sup> 1475A3
- Measuring signal cable, D-Sub 15 pole, l = 2 m <sup>1)</sup> 1700A111A2
- Measuring signal cable, D-Sub 15 pole/8x BNC neg., l = 2 m <sup>1)</sup> 1700A113A2
- Inductive proximity switch D-Sub 9 pole, l = 5 m 2233B
- Installation kit, consisting of 2 mounting brackets and 4 fastening screws 7.511.339

**Ordering Key**

DAQ-System for DynoWare incl. DynoWare Software, full licence Type 2825A	1
DAQ-System for DynoWare incl. DynoWare Software, Update Type 2825E	2

Type 5697A

<sup>1)</sup> See data sheet DynoWare (2825A\_000-371)

Windows® is a registered trade mark of Microsoft Corporation.  
 Adobe® Acrobat® Reader® is a registered trade mark of Adobe.

5697A\_000-745e-05.12