



Pressure Sensors

QBE2000-P...

for liquid and gaseous media

- Piezo-resistive measuring system
- DC 0 ...10 V output signal
- Measurement unaffected by changes in temperature
- High temperature stability
- No mechanical aging or creepage
- External thread G $\frac{1}{2}$ "
- Excellent EMC characteristics

Use

The QBE2000-P... pressure sensors are suitable for the measurement of static and dynamic positive pressure in HVAC plant, particularly in hydraulic and pneumatic systems using liquid or gaseous media (steam applications).

Technical design

The QBE2000-P... pressure sensors operate on the piezo-resistive measuring principle. The ceramics diaphragm (thick-film hybrid technology) acquires the pressure through direct contact with the medium. The measurement is converted electronically into a linear output signal of DC 0...10 V.

Type summary

Type reference	Pressure range			Signal
	0...1 bar	0...100 kPa	0 ...14.5 psi	
QBE2000-P1	0...1 bar	0...100 kPa	0 ...14.5 psi	DC 0...10 V
QBE2000-P2	0...2 bar	0...200 kPa	0 ...29.0 psi	DC 0...10 V
QBE2000-P4	0...4 bar	0...400 kPa	0 ...58.0 psi	DC 0...10 V
QBE2000-P5	0...5 bar	0...500 kPa	0 ...72.5 psi	DC 0...10 V
QBE2000-P10	0...10 bar	0...1.0 MPa	0...145.0 psi	DC 0...10 V
QBE2000-P16	0...16 bar	0...1.6 MPa	0...232.0 psi	DC 0...10 V
QBE2000-P20	0...20 bar	0...2.0 MPa	0...290.0 psi	DC 0...10 V
QBE2000-P25	0...25 bar	0...2.5 MPa	0...362.6 psi	DC 0...10 V
QBE2000-P40	0...40 bar	0...4.0 MPa	0...580.0 psi	DC 0...10 V

Ordering

When ordering, please give name and type reference, e.g.:

Pressure sensor **QBE2000-P1**

Any accessories required must be ordered separately.

Equipment combinations

The QBE2000-P... pressure sensors can be combined with all devices or systems capable of processing the DC 0 ...10 V output signal from the pressure sensor.

Mechanical design

The QBE2000-P... pressure sensors are compact units and cannot be dismantled. No changes or adjustments are possible.

Accessories

AQB22.1 Fixing bracket for sensor (for remote mounting). For dimensions, refer to "Dimensions"

AQB51.1 Mounting kit comprising:

- 2 brass thread adapters, 2 x G¹/₈" , male
- 2 copper seals, 1/₈"
- 1 m copper tube with retaining nuts at each end, G¹/₈" female
- 1 thread adapter, G¹/₈" female to G¹/₂" female, with 1 copper seal, 1/₂"
- 1 thread adapter, G¹/₈" female to R¹/₂" male
- Mounting Instructions (no. 35 757)

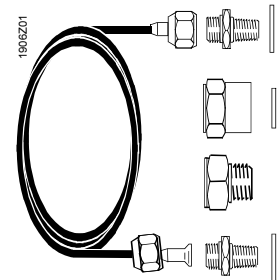

The components of the AQB51.1 mounting kit are supplied by SERTO, but the kit must be ordered from Siemens HVAC Products.

Other mounting arrangements can be ordered directly from the SERTO range.

Mounting notes

Mounting Instructions are enclosed with the sensor.

The QBE2000-P... sensors are designed for direct connection to screwed fittings with G¹/₂" threads. Appropriate measures must be taken to ensure a leak-proof fitting.

To provide for test measurements without leakage of the medium, it is strongly recommended that an appropriate test adapter and shutoff device be fitted.

Pressure measurement with liquids

The tapping point should be at the side, near the bottom of the pipe. Do not measure the pressure from the top of the pipe (where it may be affected by airlocks) or the bottom (where it may be affected by dirt). Always evacuate the system.

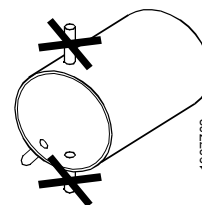

Pressure measurement with condensing gases

The tapping point should be at the top so that no condensate reaches the sensor.

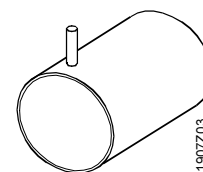

Remote mounting

If the temperature of medium is lower than $-40\text{ }^{\circ}\text{C}$ or higher than $+125\text{ }^{\circ}\text{C}$, the sensor should be fitted remotely, taking care that no condensate can reach the sensor.

For remote mounting, a fixing bracket AQB22.1 and mounting kit AQB51.1 can be delivered (refer to "Accessories").

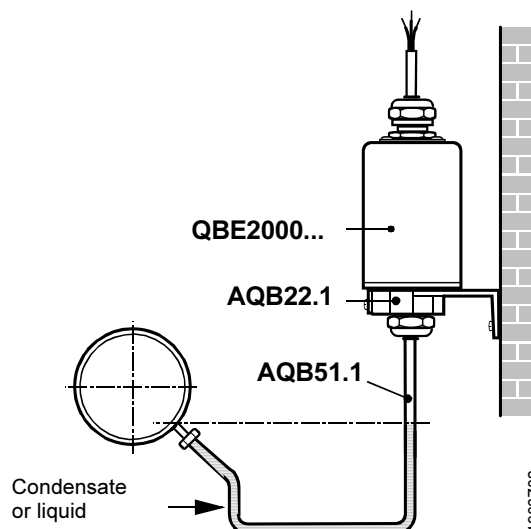

Technical data

Electrical interface	Power supply	with extra-low voltage only (SELV, PELV)
	Supply voltage	AC 24 V, 50...60 Hz or DC 16...33 V
	Max. voltage tolerance	$\pm 15\%$ at AC 24 V
	Current consumption	$< 4\text{ mA}$
	Output signal	DC 0 ... 10 V, $R_{Load} > 10\text{ k}\Omega$ (not galvanically separated, 3-wire connection, short-circuit proof and protected against polarity reversal)
Functional data	Application range	0...40 bar, refer to "Type summary"
	Accuracy:	(FS = Full Scale)
	Total of linearity, hysteresis and reproducibility	$< \pm 0.3\%$ FS
	Zero point offset voltage	$< 30\text{ mV}$
	Temperature drift:	balancing in bar
	TC zero point	$< \pm 0.015\%$ FS/K (typically)
	TC sensitivity	$< \pm 0.015\%$ FS/K (typically)
	Response time	$< 2\text{ ms}$
	Nominal pressure	relative pressure as in "Type summary" (measurement of difference from ambient pressure)
	Max. admissible pressure and rupture pressure	3 x scale end value of measuring range (FS) $< 4\text{ bar}$ 2.5 x scale end value of measuring range (FS) $> 4\text{ bar}$
	Media	neutral and slightly corrosive liquids and gases
	Admissible temperature of medium	$-40\text{...}+125\text{ }^{\circ}\text{C}$
	Maintenance	maintenance-free
Mounting position	Optional	
Protection	Protection standard	IP 67 to EN 60 529
Connections	Connecting cable	PVC, length 1.5 m, 3 x 0.25 mm ² stranded wires
	Screwed fitting	external thread G $\frac{1}{2}$ "

Environmental conditions	Operation to	IEC 721-3-3
	Climatic conditions Temperature Humidity	class 3K7 -40...+85 °C <95 % r.h.
	Storage/transport	
	Climatic conditions Temperature Humidity	-40...+85 °C <95 % r.h.
Standards	Electromagnetic compatibility	
	Immunity to	EN 61 000-6-2, EN 61 326-1
	Emissions to	EN 61 000-6-3, EN 55 022, EN 61 326-1
	CE conformity to EMC directive	89/336/EEC
Materials	CE conformity to Australian EMC Framework Radio Interference Emission Standard	Radio Communication Act 1992 AS/NZS 3548
	Base	stainless steel (1.4305)
	Measuring element	ceramics diaphragm
	Cover	stainless steel (1.4305)
Weight	Sealant	FPM fluor-caoutchouk (Viton) spec.
	Fixing bracket AQB22.1	die-cast aluminium
	Mounting kit AQB51.1	see "Accessories"
	Including packaging	0.24 kg

Internal diagram

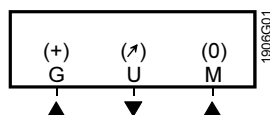

Legend

SBT terminal marking	Color of core	Meaning
G (+)	Brown	Supply voltage AC 24 V or DC 16 ... 33 V
U (↗)	Green	Output signal DC 0...10 V (signal ground GND)
M (0)	White	GND

Dimensions

QBE2000-P...

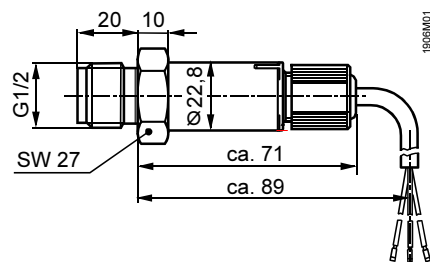

AQB22.1

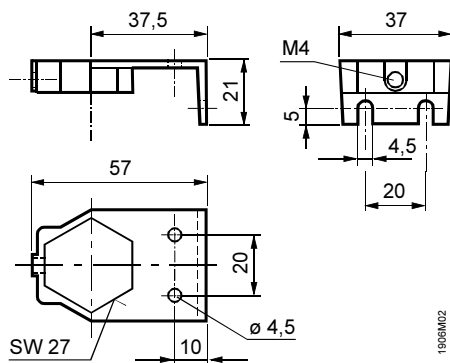

Dimensions in mm