

# COMPACT HIGH POWER RELAY

## 1 POLE—30 A (FOR AUTOMOTIVE APPLICATIONS)

### FBR56 SERIES

#### ■ FEATURES

- High power contact capacity  
(carrying current: 40 A/2 minutes, 30 A/1 hour)
- High heat resistance and extended operating voltage



#### ■ ORDERING INFORMATION

[Example]     $\frac{\text{FBR56}}{\text{(a)}} \quad \frac{\text{N}}{\text{(b)}} \quad \frac{\text{D12}}{\text{(c)}} \quad - \quad \frac{\text{W}}{\text{(d)}} \quad \frac{\text{**}}{\text{(e)}}$

(a)	Series Name	FBR56: FBR56 Series relay for 12 V battery (contact gap 0.4 mm)
(b)	Enclosure	N : Plastic sealed type
(c)	Nominal Voltage	D06 : 6 VDC D09 : 9 VDC D12 : 12 VDC
(d)	Contact Material	W : Silver-tin oxide indium N : Silver copper nickel
(e)	Custom Designation	To be assigned custom specification

**■ SPECIFICATIONS**

Item		Specifications	
Contact	Arrangement	1 form C	
	Material	Silver-tin oxide indium (-W type) Silver copper nickel (-N type)	
	Voltage Drop (resistance)	Maximum 100 mV (at 2 A 12 VDC)	
	Ratings	14 VDC 20 A (locked motor load) 14 VDC inrush 20 A, break 4 A (motor free load)	
	Maximum Carrying Current	40 A/2 minutes, 30 A/1 hour (25°C, 100% rated coil voltage)	
	Maximum Inrush Current	-W type: 60 A (reference) -N type: 40 A	
	Maximum Switching Current	40 A 16 VDC (reference)	
	Minimum Switching Load*1	-W type: 6 VDC, 1 A -N type: 6 VDC, 2 A (reference)	
Coil	Operating Temperature	-40°C to +85°C (no frost) (refer to the CHARACTERISTIC DATA)	
	Storage Temperature	-40°C to +100°C (no frost)	
Time Value	Operate (at nominal voltage)	Maximum 10 ms	
	Release (at nominal voltage)	Maximum 5 ms	
Life	Mechanical	10 × 10 <sup>6</sup> operations minimum	
	Electrical	100 × 10 <sup>3</sup> operations minimum (locked motor load) 1 × 10 <sup>6</sup> operations minimum (motor free load)	
Other	Vibration Resistance	10 to 55 Hz (double amplitude of 1.5 mm)	
	Shock Resistance	Misoperation	100 m/s <sup>2</sup>
		Endurance	1,000 m/s <sup>2</sup>
	Weight	Approximately 9.4 g	

\*1 Values when switching a resistive load at normal room temperature and humidity, and in a clean environment.  
The minimum switching load varies with the switching frequency and operating environment.

**■ COIL DATA CHART**

MODEL		Nominal voltage	Coil resistance (±10%) (at 20°C)	Must operate voltage	Thermal resistance
W contact	N contact				
FBR56ND06-W	FBR56ND06-N	6 VDC	42 Ω	3.6 VDC (at 20°C) 4.5 VDC (at 85°C)	77°C/W
FBR56ND09-W	FBR56ND09-N	9 VDC	95 Ω	5.4 VDC (at 20°C) 6.8 VDC (at 85°C)	
FBR56ND12-W	FBR56ND12-N	12 VDC	170 Ω	7.3 VDC (at 20°C) 9.2 VDC (at 85°C)	

## ■ PRINCIPAL APPLICATIONS

Application		Normal load current	Life x 10 <sup>3</sup>	Recommended model (Example)
For 12 V battery	Power Windows	20 to 30 A (switching at motor locking)	100	FBR56N□-W
	Automatic Door Lock	18 to 30 A/4 to 5 door (switching at motor locking)	100	FBR56N□-W
	Intermittent Wipers	INRUSH 15 to 30 A BREAK 2 to 8 A (motor free)	300	FBR56N□-N
	Tilt-Lock Wheel	INRUSH 15 A BREAK 2.5 A (motor free)	100	FBR56N□-W
	Sunroof	20 to 30 A (switching at motor locking)	100	FBR56N□-W
	Others	Car audio system, etc.	—	FBR56N□-W

## ■ CHARACTERISTIC DATA

### 1. MAXIMUM BREAK CAPACITY

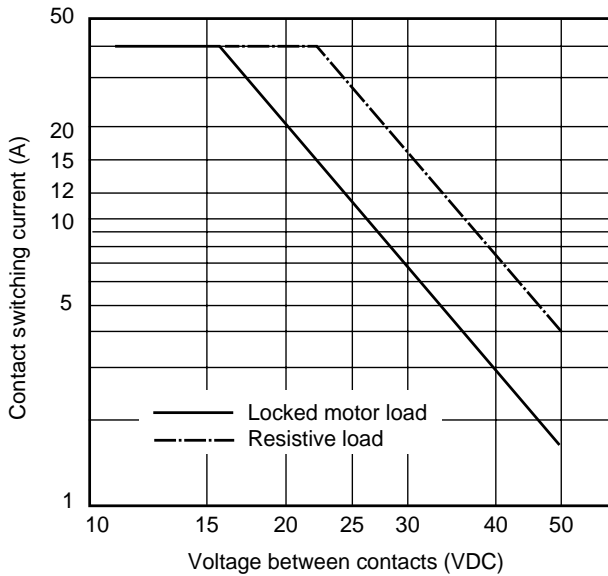

### 2. LIFE

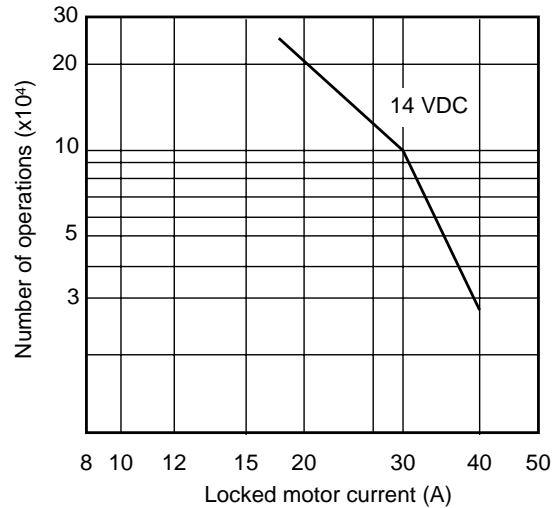

### 3. LIFE TEST (EXAMPLE)

- Test item  
14 V DC-20 A  
Motor lock  
200,000 operations minimum  
(FBR56 □-W type)

- Test circuit

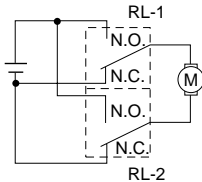

- Shift of pick-up and drop-out voltage

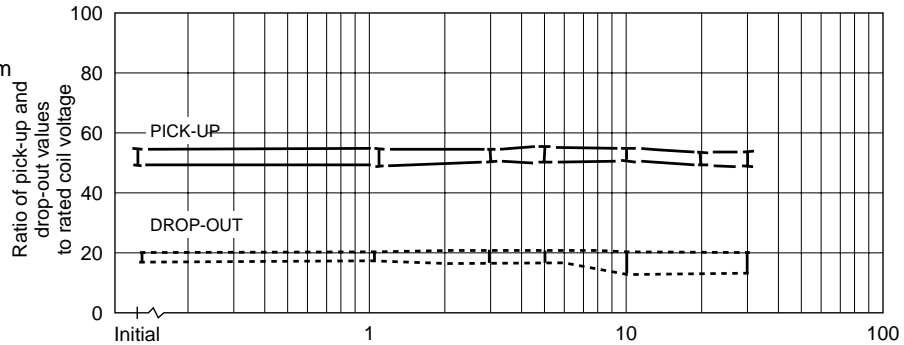

- Current wave form

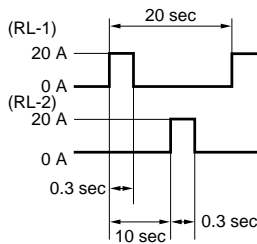

- Shift of contact resistance

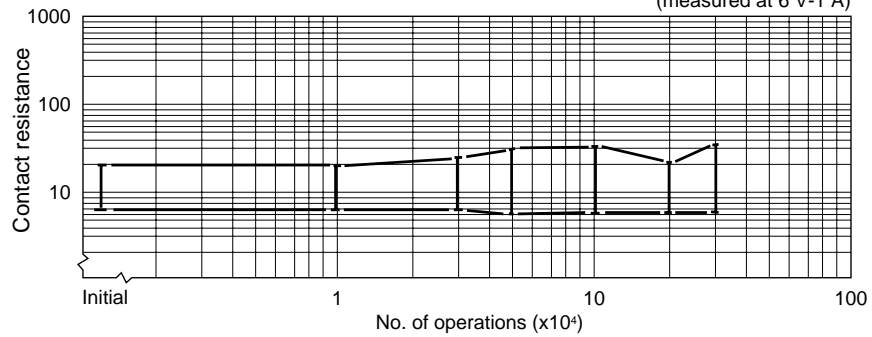

- Test item  
14 V DC-30 A  
Motor lock  
100,000 operations minimum  
(FBR56 □-W type)

- Test circuit

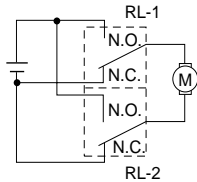

- Shift of pick-up and drop-out voltage

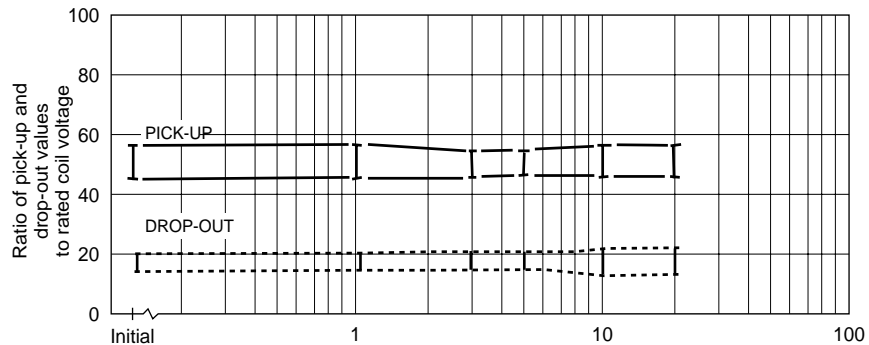

- Current wave form

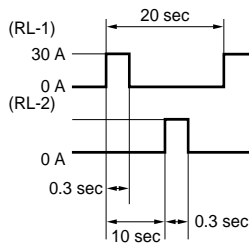

- Shift of contact resistance

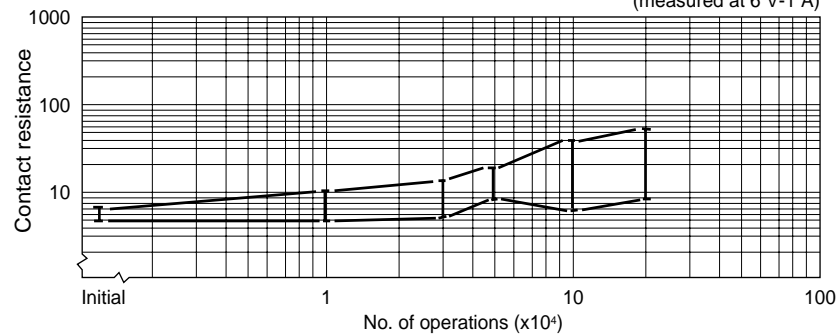

(Continued)

(Continued)

- Test item  
16 V DC-25 A INRUSH  
Motor free  
400,000 operations minimum  
(FBR56 □-N type)

- Test circuit

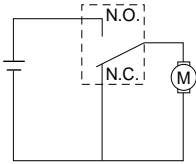

- Shift of pick-up and drop-out voltage

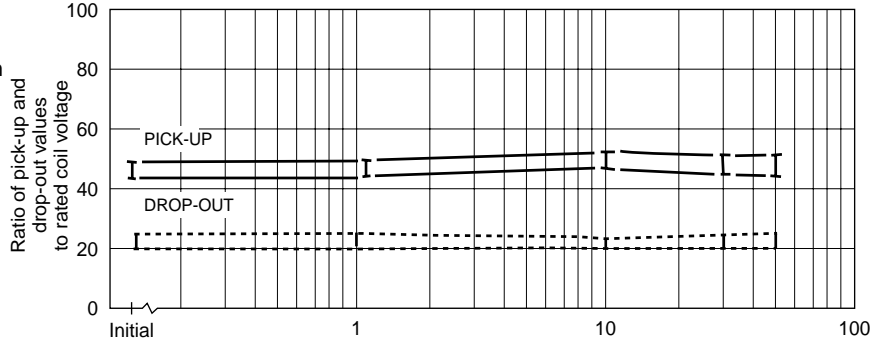

- Current wave form

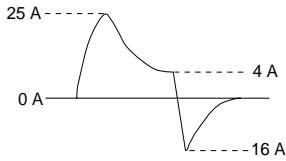

- Shift of contact resistance

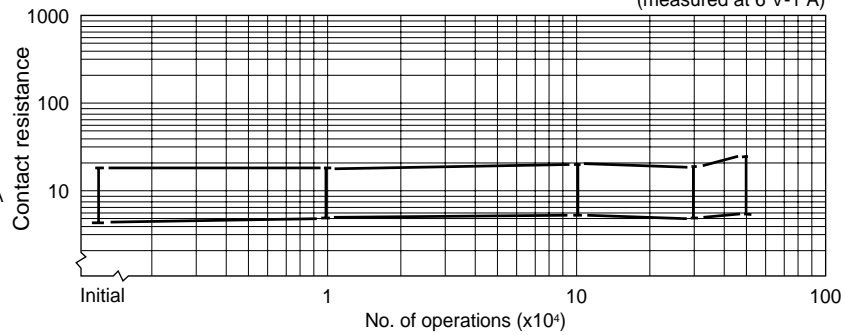

#### 4. COIL TEMPERATURE RISE

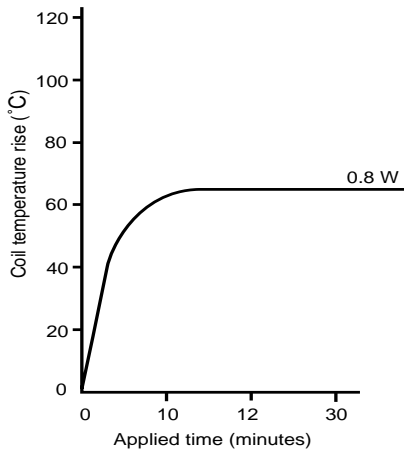

#### 5. OPERATING COIL VOLTAGE RANGE (EXAMPLE)

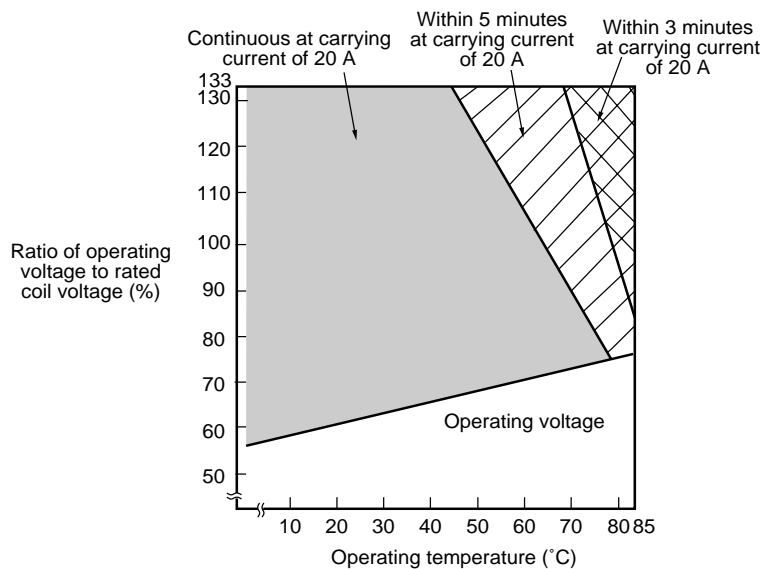

## 6. VIBRATION RESISTANCE CHARACTERISTICS

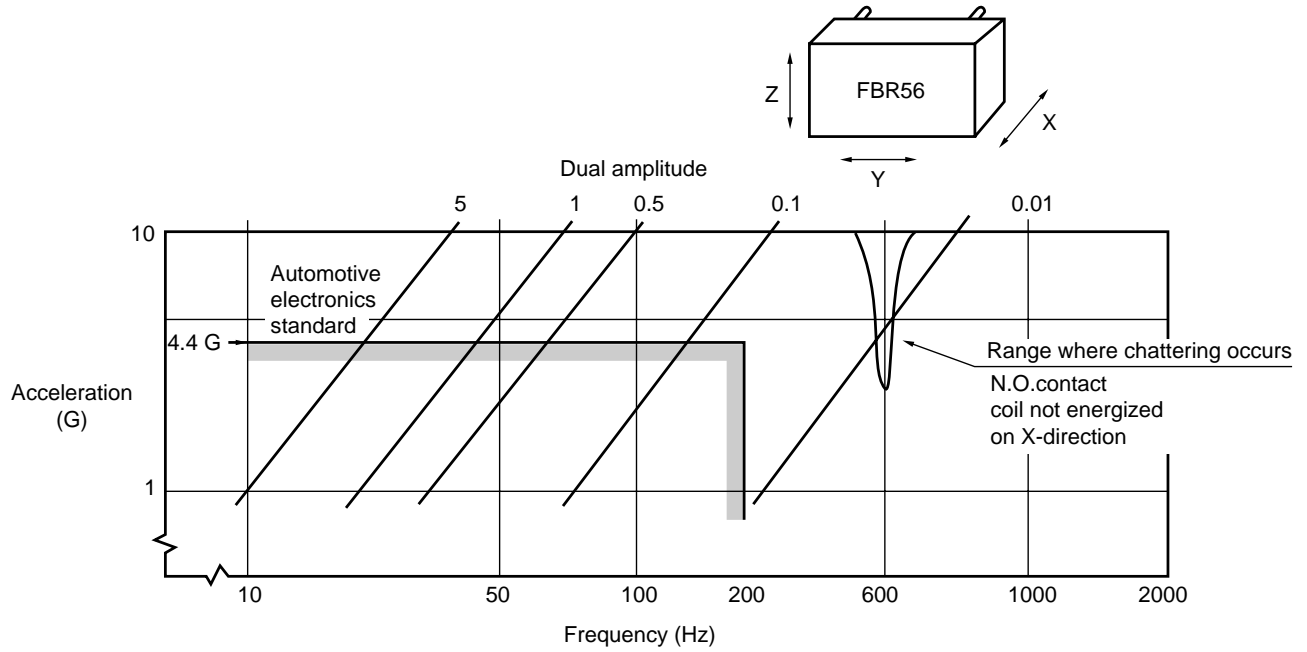

## 7. SHOCK RESISTANCE CHARACTERISTICS

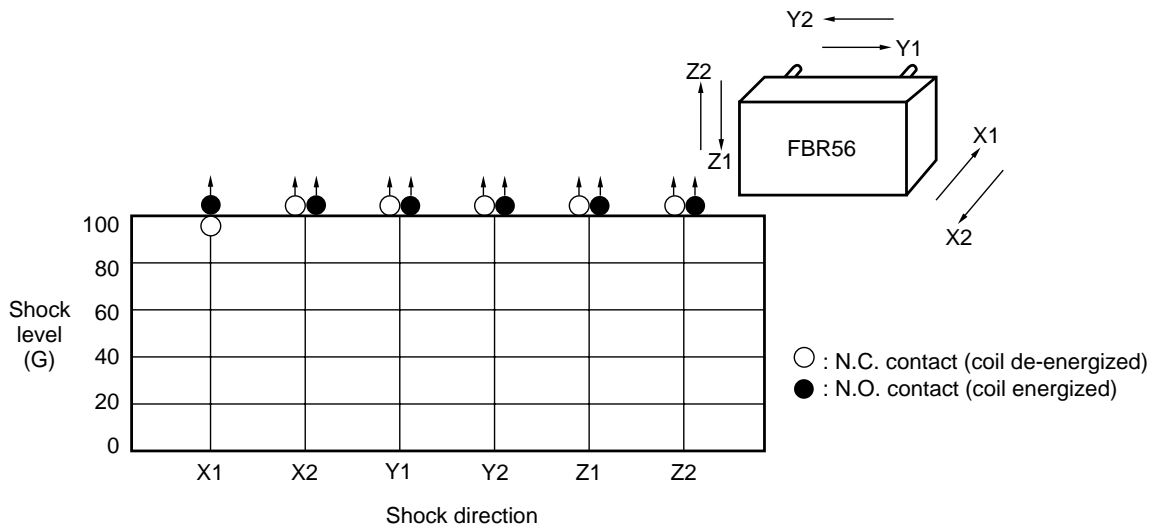

# FBR56 SERIES

## REFERENCE DATA

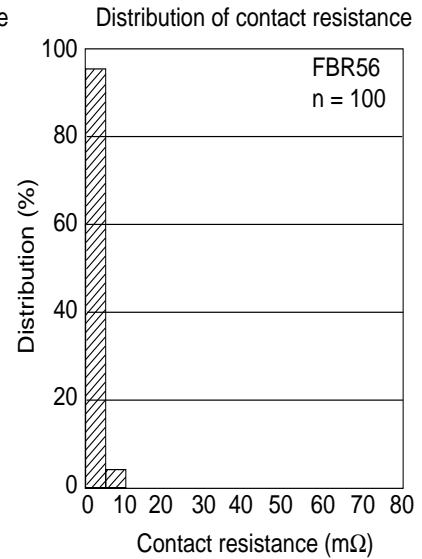
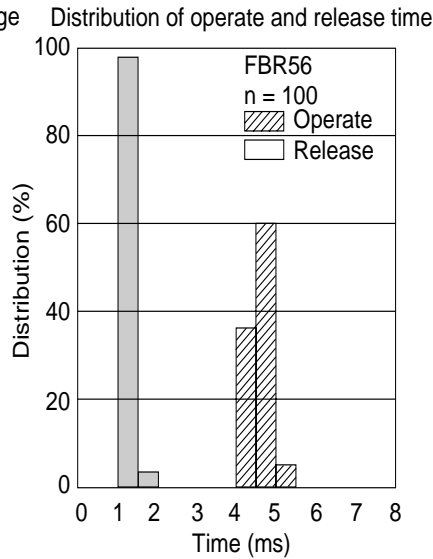
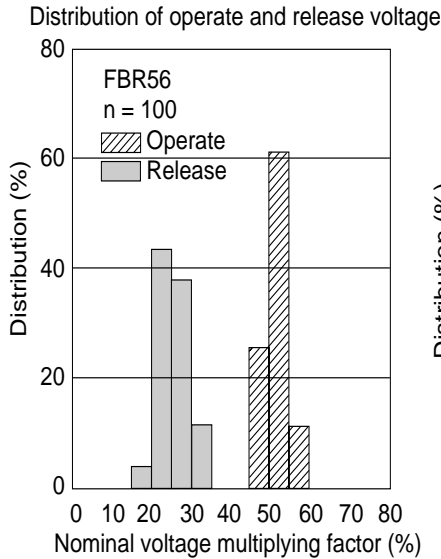

## DIMENSIONS

● Dimensions

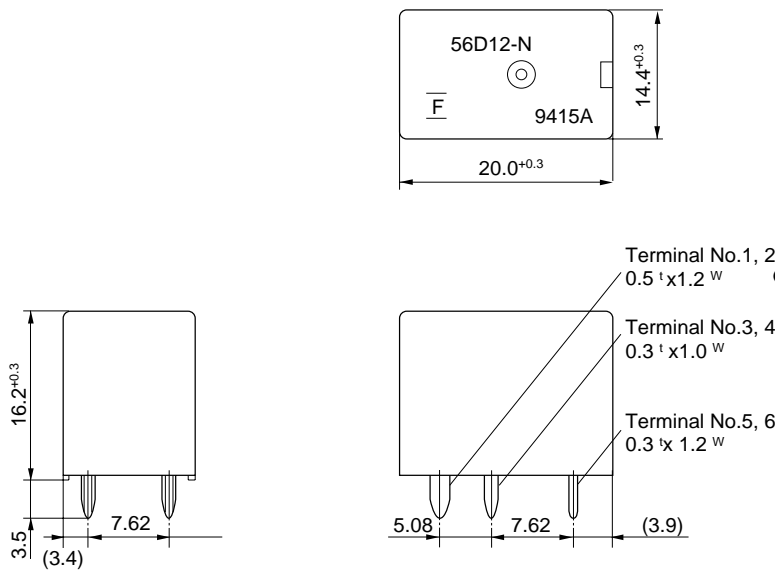

● PC board mounting hole layout (BOTTOM VIEW)

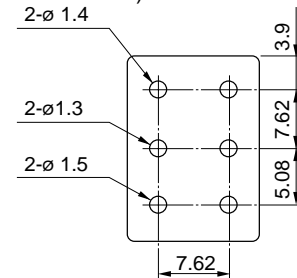

● Schematics (BOTTOM VIEW)

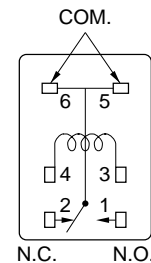

● Tube carrier

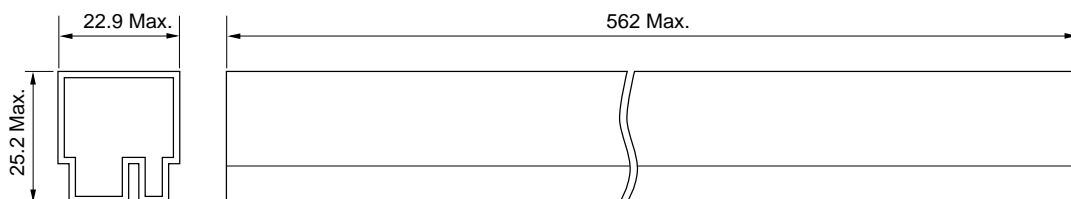

35 pcs/tube

Unit : mm

**Fujitsu Takamisawa  
International  
Headquarter  
Offices**

[www.fujitsu.takamisawa.com](http://www.fujitsu.takamisawa.com)

**Japan**

Fujitsu Takamisawa Component Limited  
Global Marketing and Sales  
Gotanda-Chuo Building  
3-5, Higashigotanda 2-chome, Shinagawa-ku  
Tokyo 141, Japan  
Tel: (81-3) 5449-7010  
Fax: (81-3) 5449-2626

**North and South America**

Fujitsu Takamisawa America, Inc.  
250 E. Caribbean Drive  
Sunnyvale, CA 94089 U.S.A.  
Tel: (1-408) 745-4900  
Fax: (1-408) 745-4970

**Europe**

Fujitsu Takamisawa Europe B.V.  
Diamantlaan 25  
2132 WV Hoofddorp  
Netherlands  
Tel: (31-23) 5560910  
Fax: (31-23) 5560950

**Asia Pacific**

Fujitsu Takamisawa Asia Pacific Pte. Ltd.  
102E Pasir Panjang Road  
#04-01 Citilink Warehouse Complex  
Singapore 118529  
Tel: (65) 375-8560  
Fax: (65) 273-3021