

SUNSTAR商斯达实业集团是集研发、生产、工程、销售、代理经销、技术咨询、信息服务等为一体的高科技企业，是专业高科技电子产品生产厂家，是具有10多年历史的专业电子元器件供应商，是中国最早和最大的仓储式连锁规模经营大型综合电子零部件代理分销商之一，是一家专业代理和分销世界各大品牌IC芯片和电子元器件的连锁经营综合性国际公司。在香港、北京、深圳、上海、西安、成都等全国主要电子市场设有直属分公司和产品展示展销窗口门市部专卖店及代理分销商，已在全国范围内建成强大统一的供货和代理分销网络。我们专业代理经销、开发生产电子元器件、集成电路、传感器、微波光电元器件、工控机/DOC/DOM电子盘、专用电路、单片机开发、MCU/DSP/ARM/FPGA软件硬件、二极管、三极管、模块等，是您可靠的一站式现货配套供应商、方案提供商、部件功能模块开发配套商。专业以现代信息产业（计算机、通讯及传感器）三大支柱之一的传感器为主营业务，专业经营各类传感器的代理、销售生产、网络信息、科技图书资料及配套产品设计、工程开发。我们的专业网站——**中国传感器科技信息网（全球传感器数据库）www.SENSOR-IC.COM** 服务于全球高科技生产商及贸易商，为企业科技产品开发提供技术交流平台。欢迎各厂商互通有无、交换信息、交换链接、发布寻求代理信息。欢迎国外高科技传感器、变送器、执行器、自动控制产品厂商介绍产品到**中国**，共同开拓市场。本网站是关于各种传感器-变送器-仪器仪表及工业自动化大型专业网站，深入到工业控制、系统工程计 测量、自动化、安防报警、消费电子等众多领域，把最新的传感器-变送器-仪器仪表买卖信息，最新技术供求，最新采购商，行业动态，发展方向，最新的技术应用和市场资讯及时的传递给广大科技开发、科学研究、产品设计人员。本网站已成功为石油、化工、电力、医药、生物、航空、航天、国防、能源、冶金、电子、工业、农业、交通、汽车、矿山、煤炭、纺织、信息、通信、IT、安防、环保、印刷、科研、气象、仪器仪表等领域从事科学研究、产品设计、开发、生产制造的科技人员、管理人员、和采购人员提供满意服务。**我公司专业生产、代理、经销、销售各种传感器、变送器、敏感元器件、开关、执行器、仪器仪表、自动化控制系统：专门从事设计、生产、销售各种传感器、变送器、各种测控仪表、热工仪表、现场控制器、计算机控制系统、数据采集系统、各类环境监控系统、专用控制系统应用软件以及嵌入式系统开发及应用等工作。如热敏电阻、压敏电阻、温度传感器、温度变送器、湿度传感器、湿度变送器、气体传感器、气体变送器、压力传感器、压力变送、称重传感器、物（液）位传感器、物（液）位变送器、流量传感器、流量变送器、电流（压）传感器、溶氧传感器、霍尔传感器、图像传感器、超声波传感器、位移传感器、速度传感器、加速度传感器、扭距传感器、红外传感器、紫外传感器、火焰传感器、激光传感器、振动传感器、轴角传感器、光电传感器、接近传感器、干簧管传感器、继电器传感器、微型电泵、磁敏（阻）传感器、压力开关、接近开关、光电开关、色标传感器、光纤传感器、齿轮测速传感器、时间继电器、计数器、计米器、温控仪、固态继电器、调压模块、电磁铁、电压表、电流表等特殊传感器。同时承接传感器应用电路、产品设计和自动化工程项目。**

欢迎索取免费详细资料、设计指南和光盘；产品凡多，未能尽录，欢迎来电查询。

更多产品请看本公司产品专用销售网站：

商斯达中国传感器科技信息网：<http://www.sensor-ic.com/>

商斯达工控安防网：<http://www.pc-ps.net/>

商斯达电子元器件网：<http://www.sunstare.com/>

商斯达微波光电产品网：[HTTP://www.rfoe.net/](http://www.rfoe.net/)

商斯达消费电子产品网：<http://www.icasic.com/>

商斯达军工产品网：<http://www.junpinic.com/>

商斯达实业科技产品网：<http://www.sunstars.cn/>传感器销售热线：

地址：深圳市福田区福华路福庆街鸿图大厦1602室

电话：0755-83607652 83376489 83376549 83370250 83370251 82500323

传真：0755-83376182 (0) 13902971329 MSN: SUNS888@hotmail.com

邮编：518033 E-mail: szss20@163.com QQ: 195847376

深圳赛格展销部：深圳华强北路赛格电子市场2583号 电话：0755-83665529

技术支持：0755-83394033 13501568376

RTX 1000



RTX 1000 Series

4-20mA Analogue/HART® Pressure Transmitters

- Ranges from 20mbar to 1400 bar
- 100:1 rangeability
- 'Best in class' performance
- Hastelloy C diaphragm supplied as standard
- Aluminium or stainless electronics housing
- NAMUR compliant alarm outputs

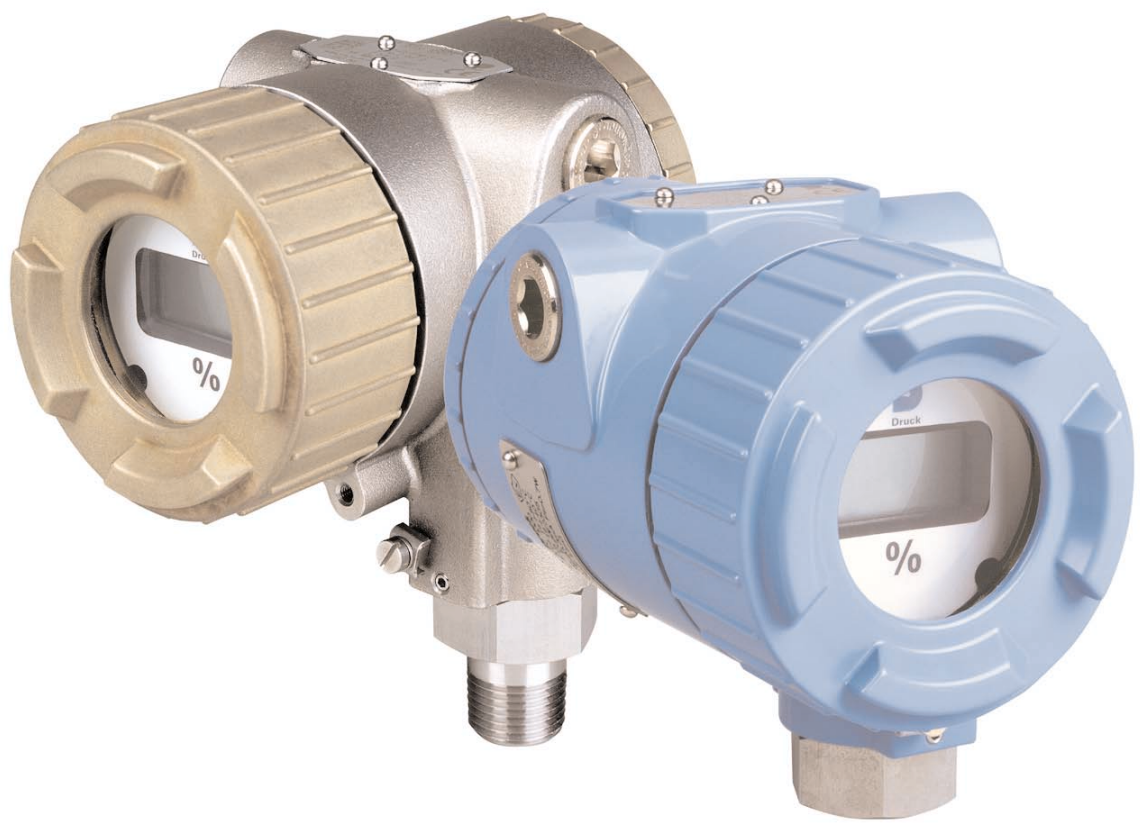

RTX 1000 Series

Versatile Transmitters for a World of Pressure

Proven Technologies

Established in 1972, GE Druck specialises in the design and manufacture of high performance pressure sensors for a wide range of applications, using its own proven micromachined silicon and related technologies.

GE Druck has its own comprehensive and technologically advanced silicon processing facility. Silicon has excellent performance characteristics and is readily adapted for many applications, from process and subsea to motorsport and aerospace.

RTX 1000 Flexibility

The RTX 1000 series provides a choice of user rangeable pressure transmitters with conventional analogue 4-20mA signal (RTX 1000 A) or with HART® digital signal superimposed (RTX 1000 H). Offering turndowns up to 100:1 and ranging from 20 mbar to 1400 bar, the RTX 1000 covers the widest range of gauge and absolute pressure applications available on the market.

High Performance

The RTX 1000 provides accuracy up to 0.075% including non-linearity, hysteresis and repeatability effects. This helps the user to achieve optimum process efficiency and ultimate product quality.

Ease of Use

Zero/span pushbuttons and a simple configuration routine reduce user set-up and calibration time. A separate terminal on the terminal block allows a meter to be connected to check calibration without breaking into the 4-20mA loop.

Low Cost of Ownership

The RTX 1000 offers high value performance and reliable long term service. For example, 5 year stability is better than 0.2%, keeping recalibration checks and process downtime to a minimum.

Media Compatibility

A Hastelloy C276 diaphragm and 316L stainless steel pressure port are supplied as standard for compatibility with a wide range of hostile media. For severe or hygienic process conditions, remote diaphragm seals can also be supplied.

Harsh Environments

The optional stainless steel electronics housing is cost-effective for applications such as offshore oil and gas or in hygienic environments such as food and beverage or pharmaceutical facilities. The Aluminium Bronze end caps ensure free-running threads throughout the life of the transmitter.

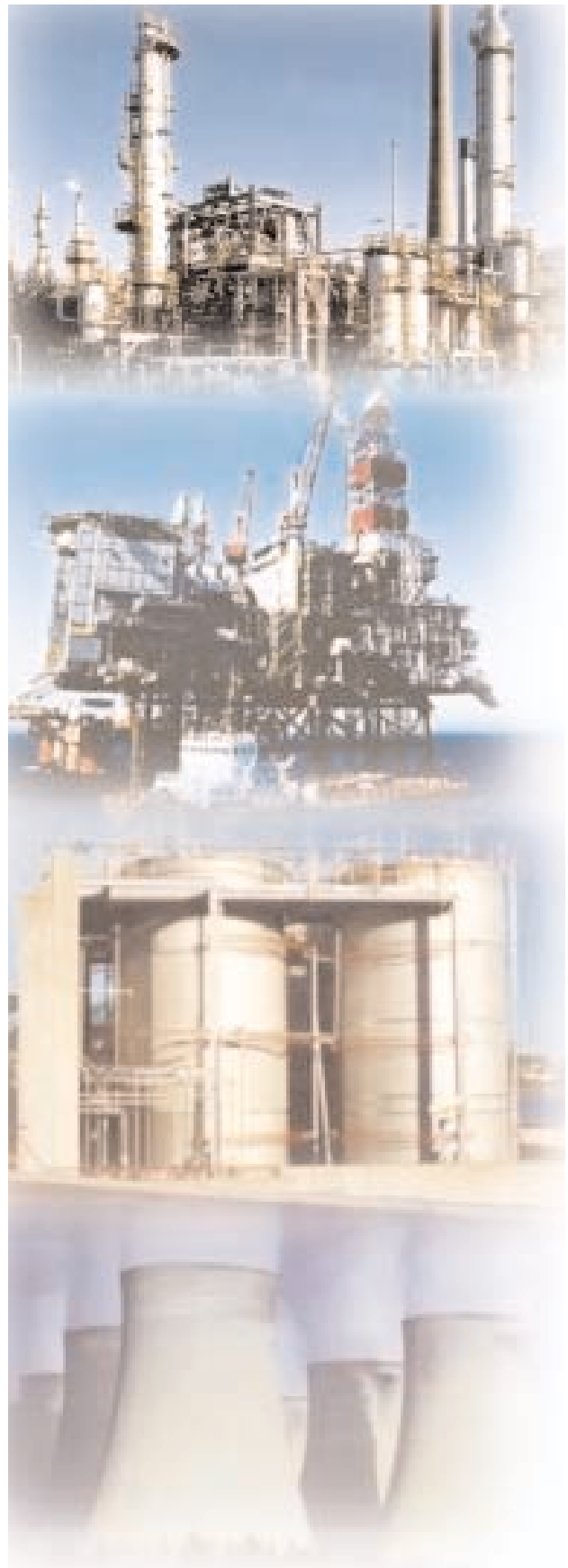



Druck



HART® Communicator

The Model 275 HART® Communicator is the most widely used communicator on the market. Supplied with 12MB of memory, it contains the device descriptions for all HART® devices regardless of manufacturer. It also holds up to 10 transmitter configurations, with optional data packs available to expand this to 100 devices.

The LCD 8 line x 21 character display simplifies access to all functions of a HART® device. A user programmable 'hot' key allows single key stroke access to the most frequently used tasks.

Remote Diaphragm Seals

Remote diaphragm seals provide a reliable means of measuring pressure whilst preventing the process fluid from directly contacting the pressure transmitter. A diaphragm seal should therefore be considered where process conditions are not directly compatible with the pressure sensor.

For example, process media which is hostile to the transmitter wetted materials, contains suspended solids or is viscous, may corrode or clog the usual transmitter impulse piping and pressure connections.

For hygienic applications such as food and beverage production, a sanitary grade pressure fitting may be required.

In addition, process temperature which cannot be brought within the required range (e.g. by use of impulse piping) may also damage the transmitter and present a safety risk.

A variety of remote diaphragm seals are available to meet these and other requirements.

Manifold Valves

A range of 2, 3 and 5 valve manifolds are available to operate with the transmitters. Manufactured from 316 stainless steel, these rugged instrument manifolds are supplied with Teflon gaskets and high tensile carbon steel bolts where applicable.

Stainless steel colour coded identity tags are affixed to individual valve head units: Blue for Isolate, Green for Equalise and Red for Vent functions. High temperature Grafoil gaskets and stainless steel bolts are available as an option and all valves are available compliant with NACE MR-01-75 for sour gas service if required.

The standard manifold valves are rated up to a maximum working pressure of 6000 psi (414 bar). Alternative a high pressure option for service up to 10,000 psi is available.

RTX 1000 Series

4-20mA Analogue/HART® Pressure Transmitters

Product Overview

GE Druck is renowned for the design and manufacture of compact and rugged high performance pressure sensors and related products for extremely accurate and reliable measurements.

The RTX 1000A (Analogue) pressure transmitters offer a cost effective solution to gauge and absolute pressure measurement with outstanding performance and conventional 4-20mA output with 10:1 turndown.

The RTX 1000H (HART®) extends the range still further to include a fully rangeable transmitter utilising the industry standard HART® protocol. This provides enhanced performance and digital two-way communication. In addition, any span can be set within a 1:1 to 100:1 ratio of the pressure module upper range limit (URL).

To adjust span, the RTX 1000 uses a simple set-up routine using pushbuttons located on the electronics board. When calibration is complete, a switch locks the pushbuttons out of the main circuit, eliminating this potential source of drift to ensure optimum long term operational stability.

Sensing Excellence

At the heart of the instrument is a micro-machined silicon sensing element. Micro-machining defines the thickness and area of the silicon which forms the pressure sensitive diaphragm and a fully active four-arm strain gauge bridge is diffused into the appropriate regions. Silicon has excellent mechanical properties being perfectly elastic and free from hysteresis, and the 'atomically' diffused gauges provide high output signals and overload capabilities.

The basic sensor is housed within a high integrity glass to metal seal, providing both electrical and physical isolation from the pressure media. The Hastelloy isolation diaphragm is electron beam welded to this seal and transmits applied pressure to the sensor via a silicone fluid filling.

Intelligent Electronics

The electronics assembly utilises microprocessor technology to create a compact circuit with the minimum of components whilst producing an extremely stable signal unaffected by shifts in ambient temperature. User selectable switches provide direct access to damping adjustment, high or low failure alarm and write protection to inhibit any unauthorised change of instrument configuration.

The electronics are enclosed in a compact and lightweight aluminum alloy housing which, in most cases, enables direct mounting to the process, eliminating the need for additional hardware. Alternatively, a stainless steel housing is also available.

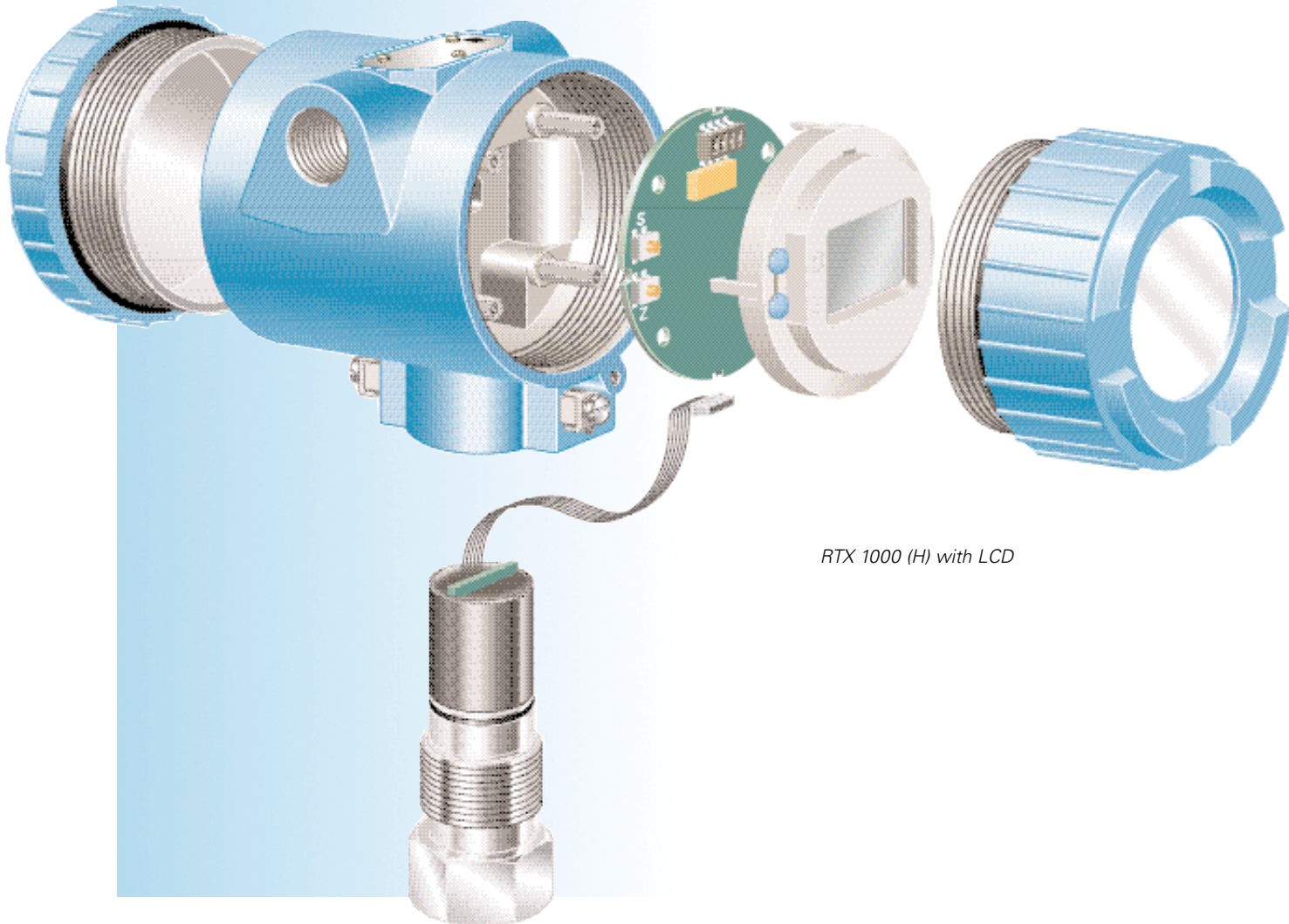

RTX 1000 (H) with LCD

STANDARD SPECIFICATIONS

Pressure Measurement

Pressure Ranges

Standard ranges which can be calibrated to any acceptable intermediate span/pressure unit:-

- 0 - 700mbar gauge or absolute
- 0 - 2 bar gauge or absolute
- 0 - 7 bar gauge or absolute
- 0 - 20 bar gauge or absolute
- 0 - 70 bar gauge or absolute
- 0 - 200 bar sealed gauge or absolute
- 0 - 700 bar sealed gauge or absolute
- 0 - 1400 bar sealed gauge or absolute

Range Adjustment

Full 4 - 20mA output change for any user span setting within Upper Range Limit (URL) as below:

- RTX 1000H: 0 - 100% URL
- RTX 1000A: 10 - 100% URL

e.g. RTX 1000 H:- 2 bar device can be adjusted down to a span of 0.02 bar (100:1 down ranging)

Zero offset - for absolute configurations:

- RTX 1000H: 0 - 99% URL
- RTX 1000A: 0 - 90% URL

For gauge configuration, the zero (4mA) output can be set anywhere within the range below:

- RTX 1000H: -1 bar to 99% URL
- RTX 1000A: -1 bar* to 90% URL
- (* -700 mbar for 700 mbar range)

e.g. 2 bar gauge device can be set 4-20mA for -1 to 1 bar. Down ranged to 0.2 bar span, 4-20mA can be set anywhere within range to a zero offset of 1.8 bar, e.g. calibrated range of 1.8 bar to 2 bar.

Overpressure

Rated pressure can be exceeded by the following multiples without degrading performance:-

- 6 x URL for 700mbar range
- 4 x URL (140 bar max) ranges 2 bar to 70 bar
- 2 x URL (900 bar max) ranges 200 bar to 700 bar
- 2000 bar max for 1400 bar range

Pressure Containment

High pressure application as below may damage sensor but process media leakage will not occur:-

- 10 x FS for 700mbar gauge range
- 6 x FS (200 bar max) ranges 2 bar to 70 bar gauge
- 200 bar for ranges up to 70 bar absolute
- 1400 bar for ranges 200/700 bar sealed gauge/abs
- 2100 bar for 1400 bar range sealed gauge/abs.

Process Media

Any liquid, gas or vapour compatible with Hastelloy C276 diaphragm and 316 stainless steel or Hastelloy C276 body. NACE MR-01-75 compliant. NB. 1400 bar range: compatible with Inconel 625.

Output Current

4 - 20mA (2 wire configuration).
RTX 1000 H:- HART® digital signal superimposed.

Failure Mode (NAMUR NE 43 compliant)

If pressure is applied outside upper or lower range settings, output saturates at Under Range 3.8 mA Over Range 20.5mA. Display flashes out of range.

In the event of failure, output will be driven to <3.6mA or >21mA (user configurable) and, if fitted, the display will confirm the alarm status.

Transmitter Supply Voltage

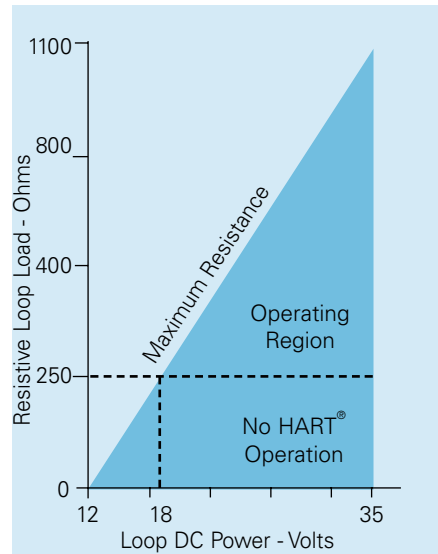

Performance

Accuracy - RTX 1000H:

For calibrated Span \geq 10% URL: 0.075% Span including non-linearity, hysteresis and repeatability.
For calibrated Span < 10% URL: (0.025% + 0.005 [URL/Span]) % Span

Accuracy - RTX 1000A:

0.15% Span (including the effects of non-linearity, hysteresis and repeatability).

Long Term Stability

At standard reference conditions, maximum calibration change 0.2% URL over a 5 year period.

Time Response

100 ms time constant (63% response to step change in pressure with damping set to 0.1 sec).

Operating Temperature Ranges

- Ambient -40° to 85°C*
- Process -40° to 120°C
- Compensated -40° to 85°C
- *(LCD option -20° to 70°C)

Temperature Effects - RTX 1000H:

Over -40 to 85°C, maximum output deviation from room temperature calibration at 23°C: 0.1% configured span+0.2% reading+0.1% URL (Reading expressed as % of configured span).

Temperature Effects - RTX 1000A:

- Over -40 to -20°C: 0.5% URL + 1% span
- Over -20 to 50°C: 0.25% URL + 0.75% span
- Over 50 to 85°C: 0.5% URL + 1% span

Mounting Position Effect

Negligible effect for ranges < 700mbar, the 'g' offset effect can be adjusted via zero controls.

Vibration Resistance

Negligible effect at 5g from 5Hz to 2kHz.

Humidity Limit

0-100% RH.

Damping

RTX 1000H: Adjustable 0.1 to 30 seconds.
RTX 1000A: 0.1 or 1 second (switch selectable).

Hazardous Area Approvals

Safe Area: Category 1 Pressure Accessory to Pressure Equipment Directive (PED) 97/23/EC. 'Maximum Span' range is equivalent to maximum working pressure (Ps) as referred to in the PED.

(I) ATEX Intrinsically Safe Approval

- CE 1180 II 1G EEx ia IIC T4 (Ta = 80°C)
- EEx ia IIC T5 (Ta = 40°C)
- to ATEX directive 94/9/EC

(D) ATEX Flameproof Approval

- CE 1180 II 2G, II 1D EEx d IIC T5 (Ta = 80°C)

(N) ATEX Type N

- Ex II 3G, II 1D EEx nI IIC T4 (Ta = 80°C)
- EEx nI IIC T5 (Ta = 40°C)

(F) FM and CSA

- Intrinsically Safe: Class I Division 1 Groups A,B,C,D
Class II Division 1 Groups E,F,G
Class III
- Explosion Proof: Class I Groups A,B,C,D
Class II Groups E,F,G
Class III
- Division 2: Class I Div 2 Groups A,B,C,D
Class II Div 2 Groups F, G
Class III Div 2 Groups F, G

All options compliant with EMC Directive 89/336/EEC EMC Emissions: EN 50081-1, EN 55022 EMC Immunity: EN 61000-6-2: 1999

CE Conformity

EMC Emissions: EN50081-1, EN55022
EMC Immunity: EN61000-6-2: 1999
PED: Pressure accessory, Category 1
Certification: CE Marked.

Physical

Electrical Connections

M20, 1/2 - 14 NPT, PG13.5 Female conduit entry.

Process Connections

Ranges up to 700 bar: G_{1/2}F, 1/2 NPTF, G_{1/2}M to BS EN 837-1 (DIN 16288), or 1/2 NPTM.
1400 bar range: 1 3/16" - 16 UN female with 60° cone (9/16" AE medium tube autoclave fitting).

Electrical Housing

Low copper aluminium alloy with epoxy painted coating or stainless steel with aluminium bronze end caps. Sealed to IP67 (NEMA 4X).

Shipping Weight

Aluminium Housing: 1.2kg (without options)
Stainless Steel Housing: 2.7kg (without options).

OPTIONS

- (A) Digital indicator:
RTX 1000H: Graphic display
RTX 1000A: 5 Digit LCD Indicator.
- (B) Mounting bracket for 2" pipe/panel, supplied in 316 stainless steel.
- (C) Material traceability for pressure containment parts to EN10204 3.1b.

CALIBRATION STANDARDS

Products manufactured by GE Druck are calibrated against precision calibration equipment which is traceable to International Standards. Continuing development sometimes means specification changes without notice.

ORDERING INFORMATION

Please determine the specific model number required by appropriate selection from the following coded areas (example is given below):

X 10		Base Model Number																	
Code	Diaphragm	Process Wetted body	Fill Fluid																
00	Hastelloy C*	316 Stainless Steel*	Silicone Oil																
10	Hastelloy C	Hastelloy C	Silicone Oil																
Code	Output																		
A	4 - 20 mA																		
H	4 - 20 mA + HART®																		
Code	Max Span	Min Span (Code A)	Min Span (Code H)																
04	0 - 700 mbar	0 - 70 mbar	N/A																
07	0 - 2 bar	0 - 200 mbar	0 - 20 mbar																
10	0 - 7 bar	0 - 700 mbar	0 - 70 mbar																
13	0 - 20 bar	0 - 2 bar	0 - 200 mbar																
16	0 - 70 bar	0 - 7 bar	0 - 700 mbar																
18	0 - 200 bar	0 - 20 bar	0 - 2 bar																
22	0 - 700 bar	0 - 70 bar	0 - 7 bar																
24	0 - 1400 bar**	0 - 140 bar	0 - 14 bar																
Code	Type																		
A	Absolute																		
G	Gauge (sealed gauge for ranges above 70 bar)																		
Code	Process Connection																		
1	G ¹ / ₂ female																		
2	1/2 - 14 NPT female																		
3	G ¹ / ₂ male to BS EN 837-1 (DIN 16288)																		
4	1/2 NPT male																		
5	9/16 AE medium pressure tube autoclave fitting***																		
Code	Electrical Entry																		
M	M20 female																		
N	1/2 - 14 NPT female (via adaptor)																		
P	PG 13.5 female (via adaptor)																		
Code	Electronics Housing																		
0	Aluminium Alloy																		
S	Stainless Steel																		
Code	Approvals																		
O	Safe Area																		
I	ATEX Intrinsically Safe																		
D	ATEX Flameproof																		
N	ATEX Type 'N'																		
F	FM/CSA Intrinsically Safe / Explosion proof / Division 2																		
Code	Options																		
O	None																		
LA	Digital Indicator (with output code A)																		
LH	Digital Indicator (with output code H)																		
B	Mounting Bracket																		
T	DIN 3.1B Material Certificate																		
X 10	00	-	H	-	07	-	G	-	1	-	M	-	0	-	D	-	LHB	Typical Model Number	

* For 1400 bar device (range code 24) diaphragm and process wetted body is Inconel 625.

** Available with process connection code 5 only and approvals options O, I or N.

*** Process connection code 5/Autoclave fitting applies to range code 24 (0 - 1400 bar) only.



Druck

Installation Drawings - Dimensions in mm

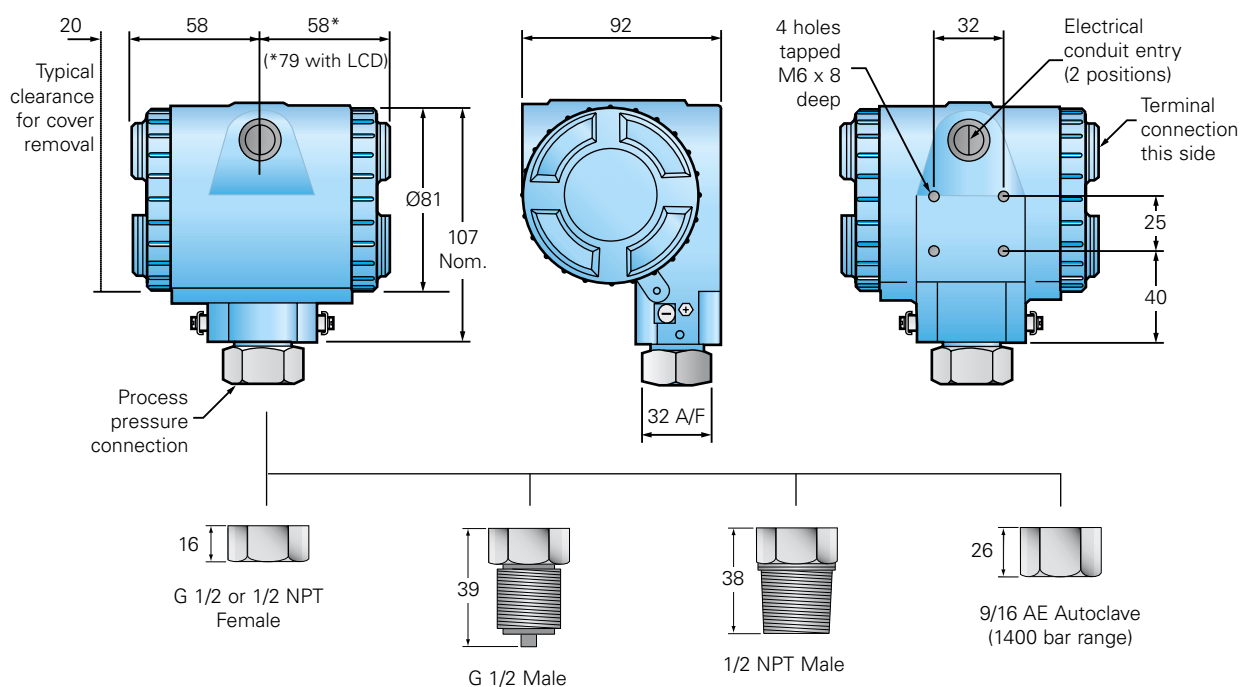

Installation - With Optional Mounting Bracket

Example - Panel Mounting

Examples - Horizontal Pipe Mounting

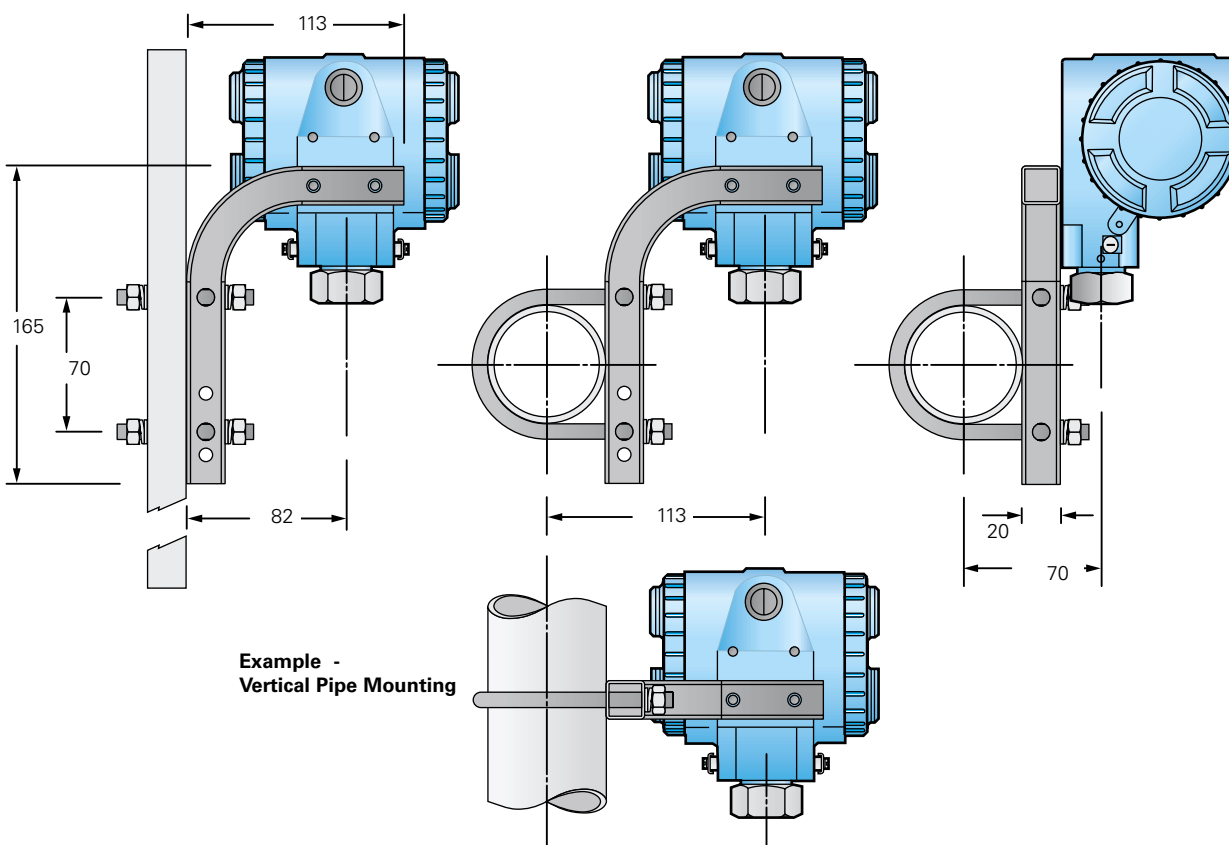

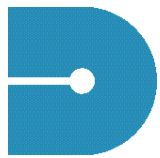

Related Products

**Differential Pressure Transmitter
STX 2100 HART®**



- Ranges up to 20 bar
- Line pressures to 140 bar
- 0.1% accuracy

**Slimline Pressure Transmitter
PTX 7800 Series**



- Range from 70mbar to 700 bar
- Diameter 30mm
- Intrinsically Safe/Flameproof

**Heavy Duty Pressure Transmitter
PTX 7900 Series**



- Range from 70mbar to 700 bar
- Intrinsically Safe/Flameproof
- Stainless/aluminium bronze housing

**Low Pressure Transmitter
LP1000 Series**



- Ranges from 0.25mbar to 15mbar
- Gauge and differential
- Ideal for HVAC and cleanrooms

**Slimline Level Transmitter
1830 Series**



- All Titanium body material
- Compact 17.5mm diameter
- Suitable for tank level applications

**Loop Calibrator
UPS III**



- Rugged, compact/pocket size
- Measure and source 0 - 24 mA
- Accuracy 0.01% of reading

**Portable Pressure Calibrators
DPI 615/DPI 615IS**



- From 2.5mbar to 700 bar
- Accuracy to 0.025% F.S.
- Pneumatic and hydraulic

**Portable Multifunction Calibrators
TRX II/TRX II IS**



- Pressure/temperature/electrical
- Dual readout: Measure and source
- Fully documenting - RS232/PCMCIA

**High Pressure Pneumatic Calibrators
DPI 320/325**



- From 35 bar to 200 bar
- Rugged and fully portable
- Self contained pressure source



GE Druck

Agent

Druck Limited
Fir Tree Lane, Groby, Leicester LE6 0FH UK
Tel: +44 (0) 116 231 7100, Fax: +44 (0) 116 231 7103
E-mail: sales@druck.com www.druck.com