

GaAs MMIC 6-BIT DIGITAL PHASE SHIFTER, 2.5 - 3.1 GHz

Typical Applications

The HMC647 is ideal for:

- EW Receivers
- Weather & Military Radar
- Satellite Communications
- Beamforming Modules
- Phase Cancellation

Features

- Low RMS Phase Error: 1.0°
- Low Insertion Loss: 4 dB
- High Linearity: +54 dBm
- Positive Control Logic
- 360° Coverage, LSB = 5.625°
- Die Size: 3.85 x 1.90 x 0.1 mm

Functional Diagram

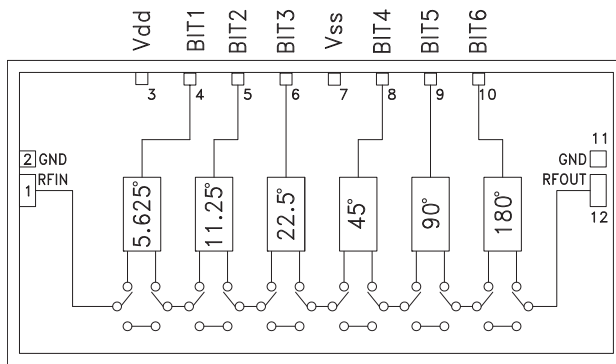

General Description

The HMC647 is a 6-bit digital phase shifter die which is rated from 2.5 to 3.1 GHz, providing 360 degrees of phase coverage, with a LSB of 5.625 degrees. The HMC647 features very low RMS phase error of 1.0 degrees and extremely low insertion loss variation of ± 0.5 dB across all phase states. This high accuracy phase shifter is controlled with positive control logic of 0/+5V, and is internally matched to 50 Ohms with no external components.

Electrical Specifications, $T_A = +25^\circ C$, Vss = -5V, Vdd = +5V, Control Voltage = 0/+5V, 50 Ohm System

Parameter	Min.	Typ.	Max.	Units
Frequency Range	2.5		3.1	GHz
Insertion Loss*		4	6	dB
Input Return Loss*		16		dB
Output Return Loss*		17		dB
Phase Error*		± 3	+5 / -15	deg
RMS Phase Error		1.0		deg
Insertion Loss Variation*		± 0.5		dB
Input Power for 1 dB Compression		31		dBm
Input Third Order Intercept		54		dBm
Control Voltage Current		35	250	μA
Bias Control Current		5	15	mA

*Note: Major States Shown

GaAs MMIC 6-BIT DIGITAL PHASE SHIFTER, 2.5 - 3.1 GHz

Insertion Loss, Major States Only

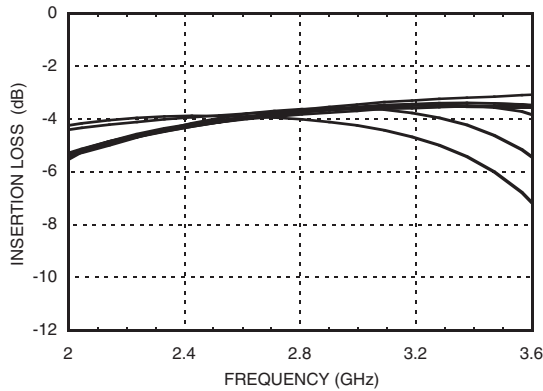

Normalized Loss, Major States Only

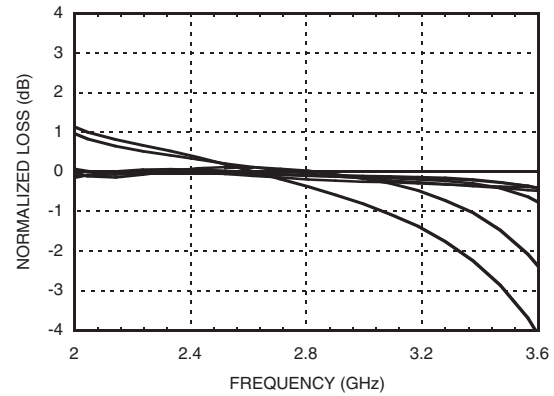

Input Return Loss, Major States Only

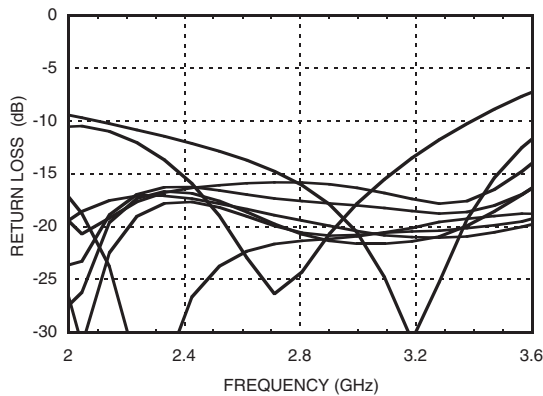

Phase Error, Major States Only

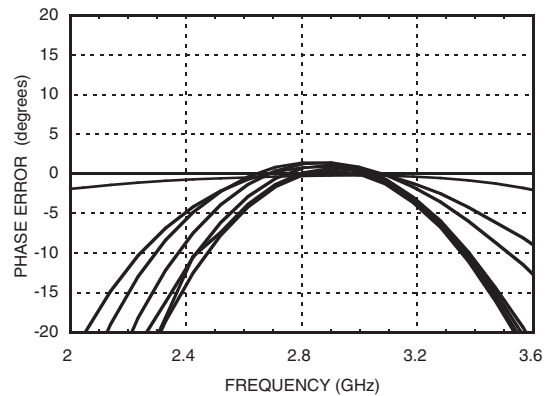

Output Return Loss, Major States Only

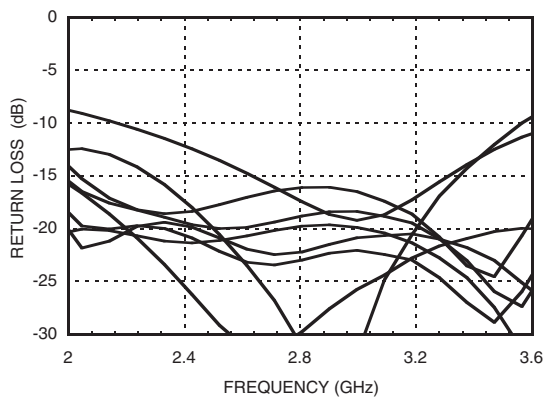

Relative Phase Shift Major States, Including All Bits

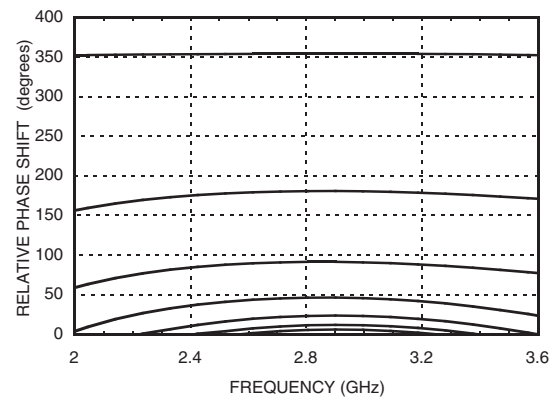

GaAs MMIC 6-BIT DIGITAL PHASE SHIFTER, 2.5 - 3.1 GHz

Relative Phase Shift, RMS, Average, Max, All States

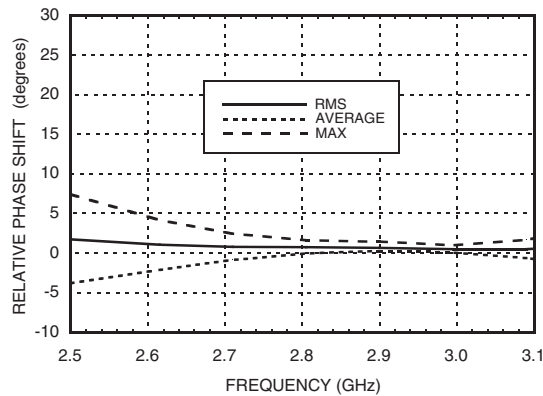

Input IP3, Major States Only

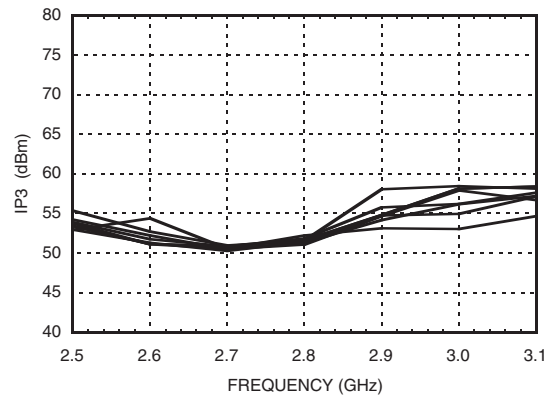

Input IP2, Major States Only

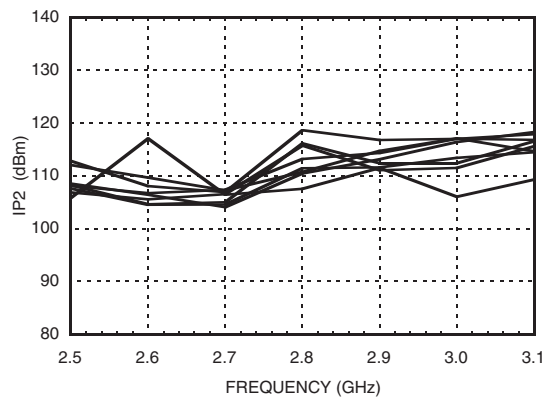

Input P1dB, Major States Only

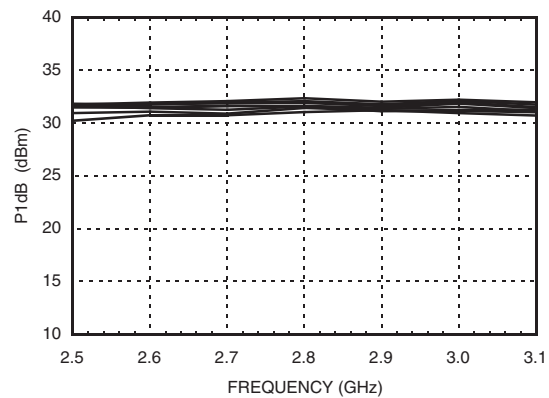

RMS Phase Error vs. Temperature

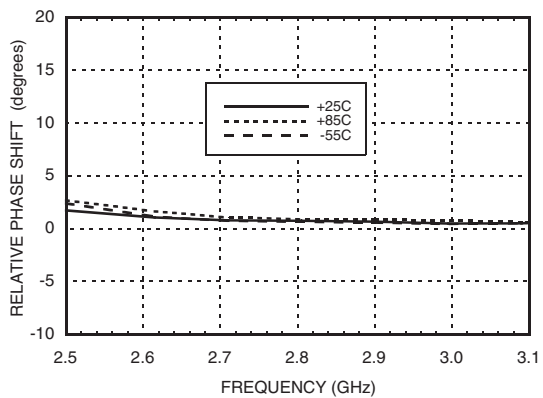

Insertion Loss vs. Temperature, Major States Only

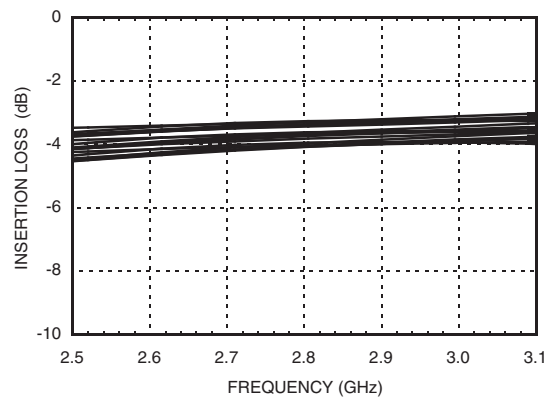

GaAs MMIC 6-BIT DIGITAL PHASE SHIFTER, 2.5 - 3.1 GHz

Phase Error vs. State

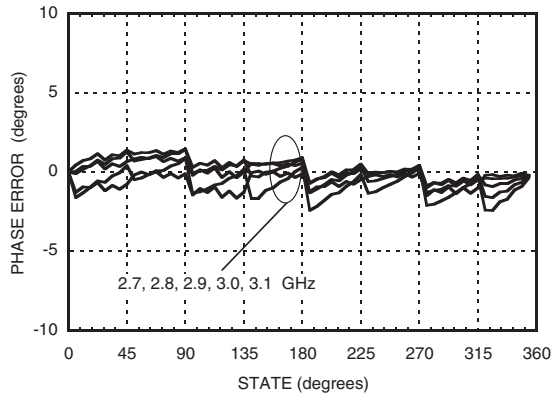

Absolute Maximum Ratings

Input Power (RFIN)	33 dBm (T= +85 °C)
Bias Voltage Range (Vdd)	-0.2 to +12V
Bias Voltage Range (Vss)	+0.2 to -12V
Channel Temperature (Tc)	150 °C
Thermal Resistance (channel to die bottom)	140 °C/W
Storage Temperature	-65 to +150 °C
Operating Temperature	-55 to +85 °C



ELECTROSTATIC SENSITIVE DEVICE
OBSERVE HANDLING PRECAUTIONS

Truth Table

Control Voltage Input						Phase Shift (Degrees) RFIN - RFOUT
Bit 1	Bit 2	Bit 3	Bit 4	Bit 5	Bit 6	
0	0	0	0	0	0	Reference*
1	0	0	0	0	0	5.625
0	1	0	0	0	0	11.25
0	0	1	0	0	0	22.5
0	0	0	1	0	0	45.0
0	0	0	0	1	0	90.0
0	0	0	0	0	1	180.0
1	1	1	1	1	1	354.375

Any combination of the above states will provide a phase shift approximately equal to the sum of the bits selected.

*Reference corresponds to monotonic setting

Bias Voltage & Current

Vdd	Idd
5.0	5.3mA
Vss	Iss
-5.0	5.3mA

Control Voltage

State	Bias Condition
Low (0)	0 to 0.2 Vdc
High (1)	Vdd ±0.2 Vdc @ 35 µA Typ.

Pad Descriptions

Pad Number	Function	Description	Interface Schematic
1	RFIN	This port is DC coupled and matched to 50 Ohms.	
2, 11	GND	These pads and die bottom must be connected to RF/DC ground.	
3	Vdd	Supply voltage.	
4 - 6, 8 - 10	BIT1, BIT2, BIT3, BIT4, BIT5, BIT6	Control Input. See truth table and control voltage tables.	
7	Vss	Supply voltage.	
12	RFOUT	This port is DC coupled and matched to 50 Ohms.	

GaAs MMIC 6-BIT DIGITAL PHASE SHIFTER, 2.5 - 3.1 GHz

Outline Drawing

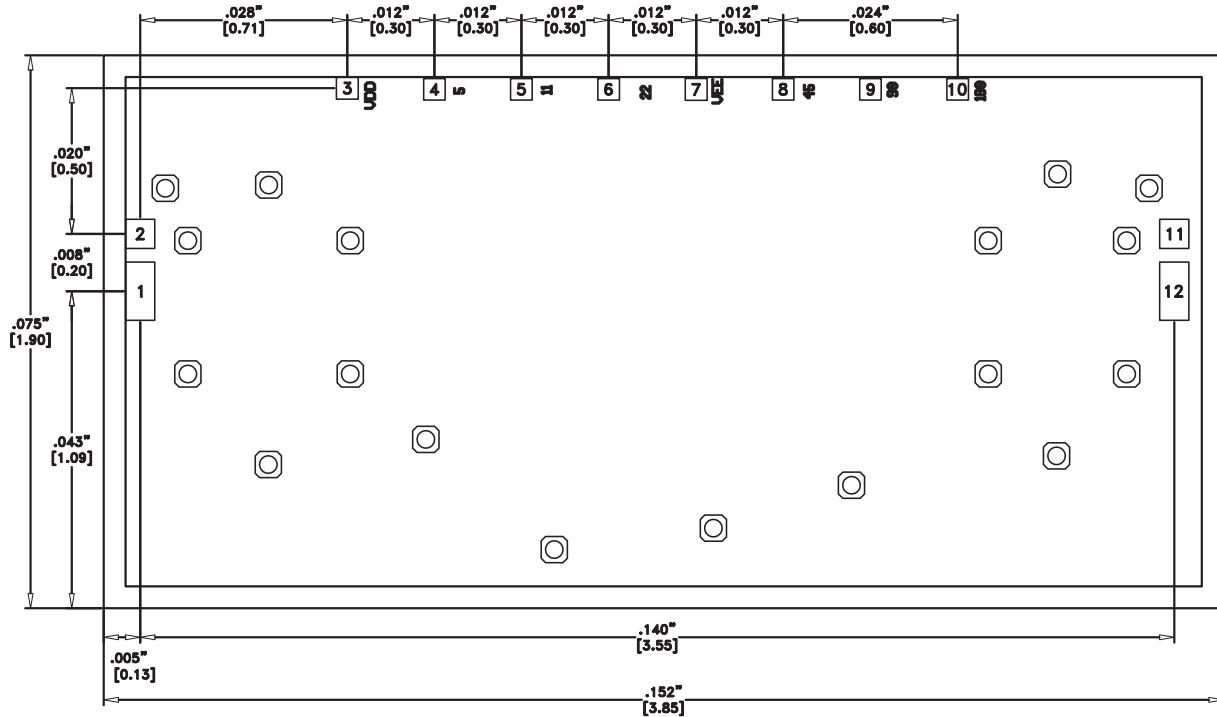

Die Packaging Information [1]

Standard	Alternate
GP-1 (Gel Pack)	[2]

[1] Refer to the "Packaging Information" section for die packaging dimensions.

[2] For alternate packaging information contact Hittite Microwave Corporation.

NOTES:

1. ALL DIMENSIONS IN INCHES (MILLIMETERS)
2. DIE THICKNESS IS 0.004
3. BACKSIDE METALLIZATION: GOLD
4. BACKSIDE METAL IS GROUND
5. BOND PADS METALLIZATION: GOLD
6. OVERALL DIE SIZE ± 0.002

GaAs MMIC 6-BIT DIGITAL PHASE SHIFTER, 2.5 - 3.1 GHz

Assembly Diagram

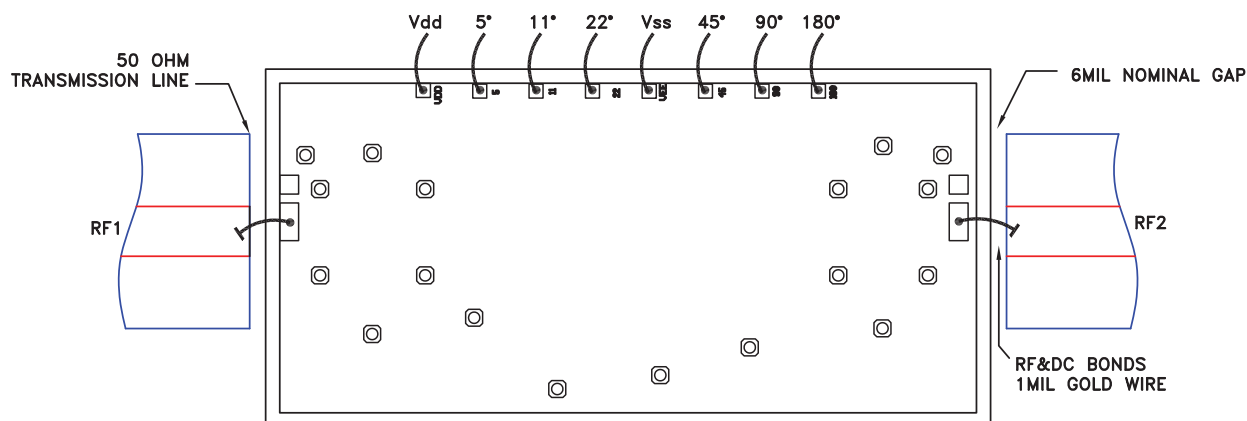

Handling Precautions

Follow these precautions to avoid permanent damage.

Storage: All bare die are placed in either Waffle or Gel based ESD protective containers, and then sealed in an ESD protective bag for shipment. Once the sealed ESD protective bag has been opened, all die should be stored in a dry nitrogen environment.

Cleanliness: Handle the chips in a clean environment. DO NOT attempt to clean the chip using liquid cleaning systems.

Static Sensitivity: Follow ESD precautions to protect against > ± 250V ESD strikes.

Transients: Suppress instrument and bias supply transients while bias is applied. Use shielded signal and bias cables to minimize inductive pick-up.

General Handling: Handle the chip along the edges with a vacuum collet or with a sharp pair of bent tweezers. The surface of the chip has fragile air bridges and should not be touched with vacuum collet, tweezers, or fingers.

Mounting

The chip is back-metallized and can be die mounted with electrically conductive epoxy. The mounting surface should be clean and flat.

Epoxy Die Attach: Apply a minimum amount of epoxy to the mounting surface so that a thin epoxy fillet is observed around the perimeter of the chip once it is placed into position. Cure epoxy per the manufacturer's schedule.

Wire Bonding

Ball or wedge bond with 0.025mm (1 mil) diameter pure gold wire. Thermosonic wirebonding with a nominal stage temperature of 150 deg. C and a ball bonding force of 40 to 50 grams or wedge bonding force of 18 to 22 grams is recommended. Use the minimum level of ultrasonic energy to achieve reliable wirebonds. Wirebonds should be started on the chip and terminated on the package or substrate. All bonds should be as short as possible <0.31mm (12 mils).