

**GaAs pHEMT MMIC 1/2 WATT
 POWER AMPLIFIER, 24 - 29.5 GHz**

Typical Applications

The HMC863 is ideal for:

- Point-to-Point Radios
- Point-to-Multi-Point Radios
- VSAT
- Military & Space

Features

- Saturated Output Power: +28 dBm @ 18% PAE
- High Output IP3: +39 dBm
- High Gain: 27 dB
- DC Supply: +6V @ 375mA
- 50 Ohm Matched Input/Output
- Die Size: 2.41 x 0.95 x 0.1 mm

Functional Diagram

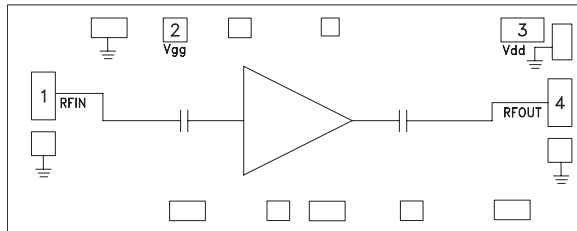

General Description

The HMC863 is a three stage GaAs pHEMT MMIC 1/2 Watt Power Amplifier which operates between 24 and 29.5 GHz. The HMC863 provides 27 dB of gain, and +27 dBm of saturated output power at 18% PAE from a +6V supply. The RF I/Os are DC blocked and matched to 50 Ohms for ease of integration into Multi-Chip-Modules (MCMs). All data is taken with the chip in a 50 Ohm test fixture connected via 0.025 mm (1 mil) diameter wire bonds of length 0.31 mm (12 mils).

Electrical Specifications, $T_A = +25^\circ C$, $V_{dd} = +6V$, $I_{dd} = 375mA$ ^[1]

Parameter	Min.	Typ.	Max.	Min.	Typ.	Max.	Units
Frequency Range	24 - 27		27 - 29.5				GHz
Gain	24	27		22	25		dB
Gain Variation Over Temperature		0.0375			0.05		dB/ °C
Input Return Loss		17			11		dB
Output Return Loss		15			11		dB
Output Power for 1 dB Compression (P1dB)	24	27		23	26		dBm
Saturated Output Power (P _{sat})		28			27		dBm
Output Third Order Intercept (IP3) ^[2]		37			38		dBm
Total Supply Current (I _{dd})		375			375		mA

[1] Adjust V_{gg} between -2 to 0V to achieve I_{dd}= 375mA typical.
 [2] Measurement taken at +6V @ 375mA, P_{out} / Tone = +16 dBm

**GaAs pHEMT MMIC 1/2 WATT
POWER AMPLIFIER, 24 - 29.5 GHz**

**Broadband Gain &
Return Loss vs. Frequency**

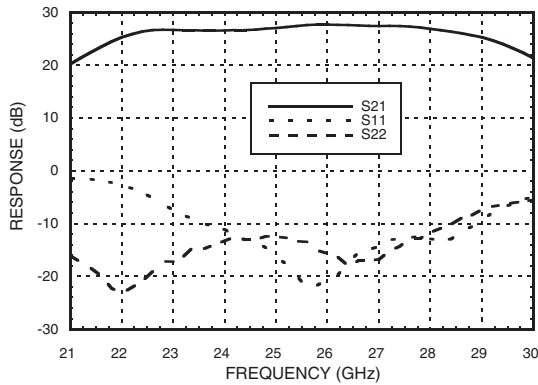

Gain vs. Temperature

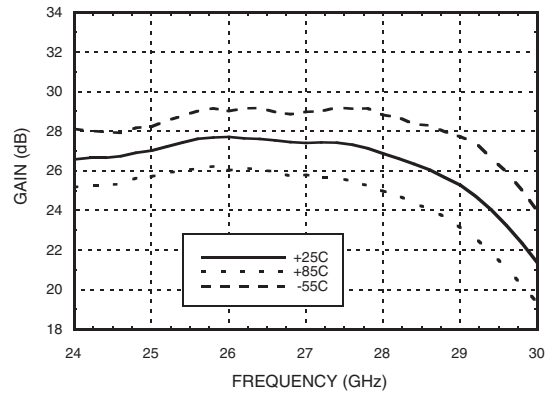

Input Return Loss vs. Temperature

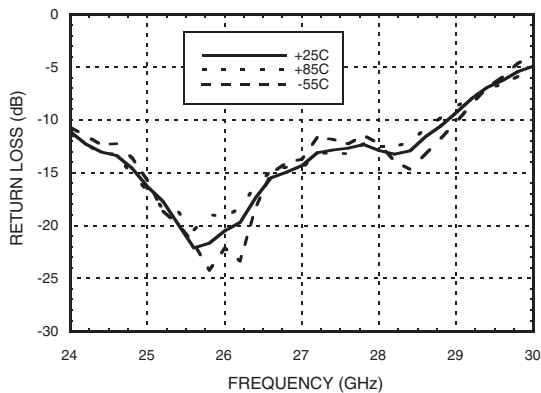

Output Return Loss vs. Temperature

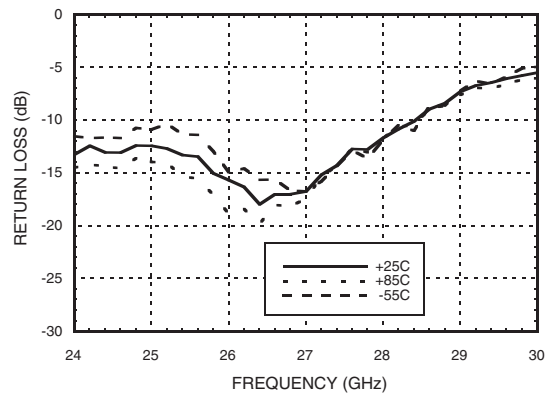

P1dB vs. Temperature

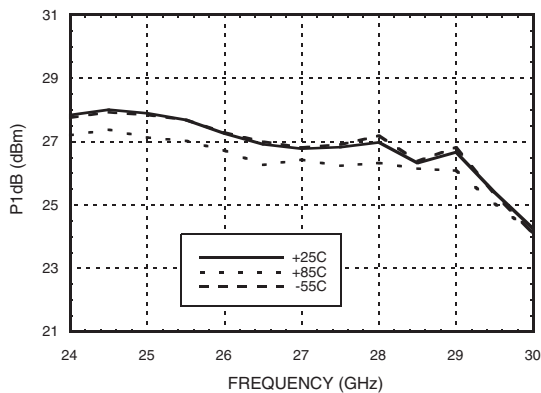

P1dB vs. Supply Voltage

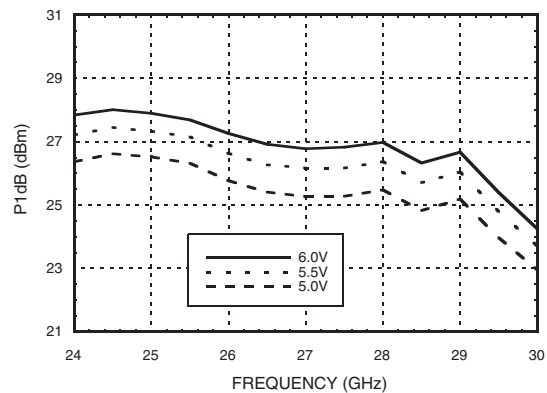

**GaAs pHEMT MMIC 1/2 WATT
POWER AMPLIFIER, 24 - 29.5 GHz**

Psat vs. Temperature

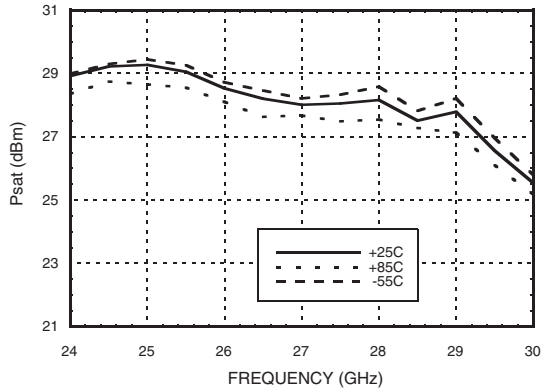

Psat vs. Supply Voltage

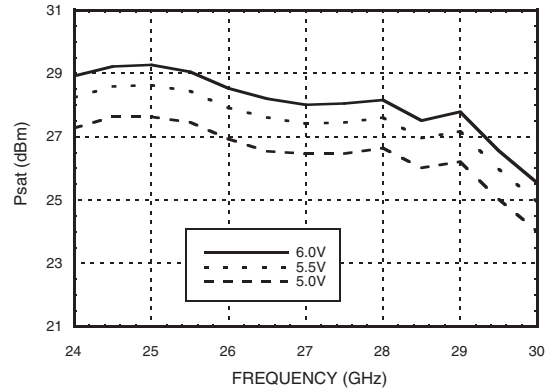

P1dB vs. Supply Current (Idd)

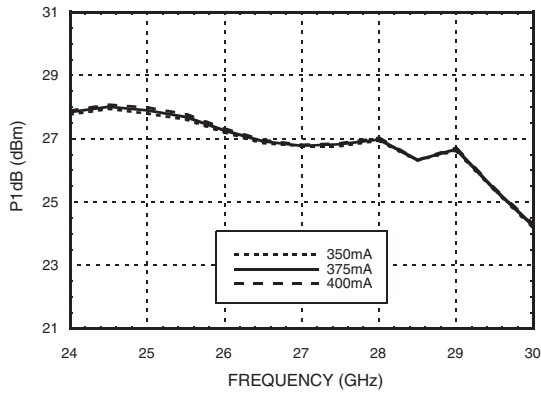

Psat vs. Supply Current (Idd)

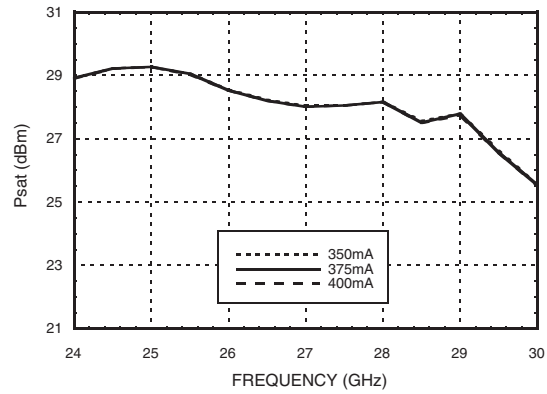

**Output IP3 vs.
Temperature, Pout/Tone = +16 dBm**

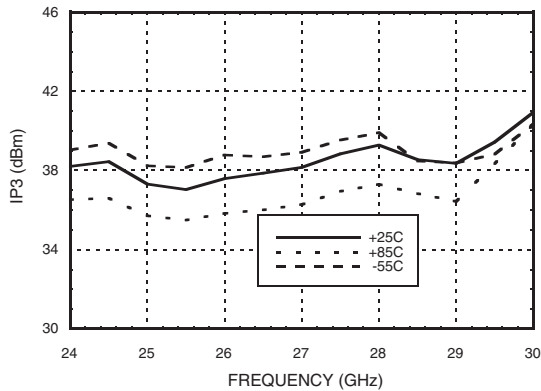

**Output IP3 vs.
Supply Current, Pout/Tone = +16 dBm**

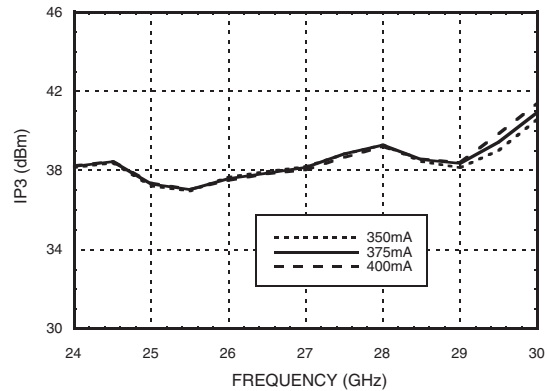

**GaAs pHEMT MMIC 1/2 WATT
POWER AMPLIFIER, 24 - 29.5 GHz**

**Output IP3 vs.
Supply Voltage, Pout/Tone = +16 dBm**

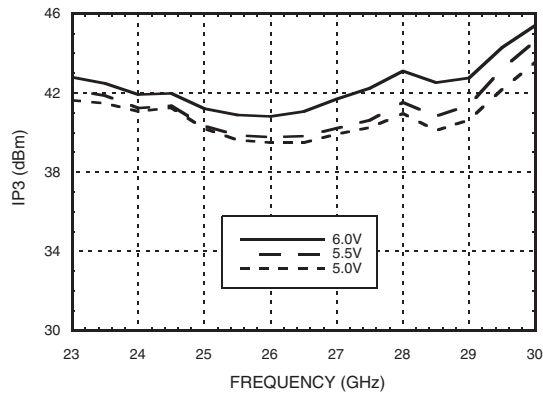

Output IM3 @ Vdd = +5V

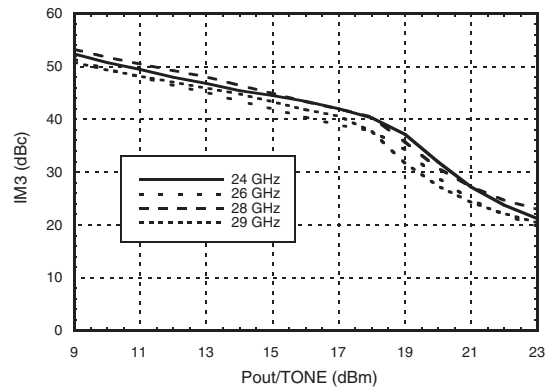

Output IM3 @ Vdd = +5.5V

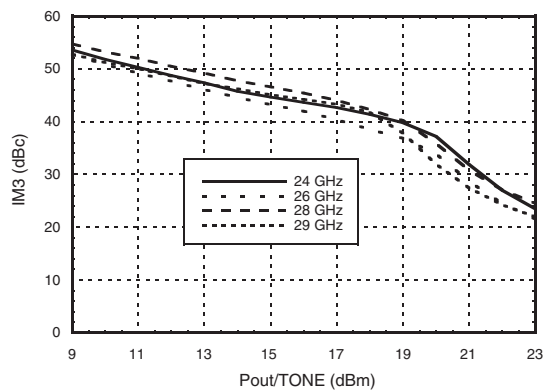

Output IM3 @ Vdd = +6V

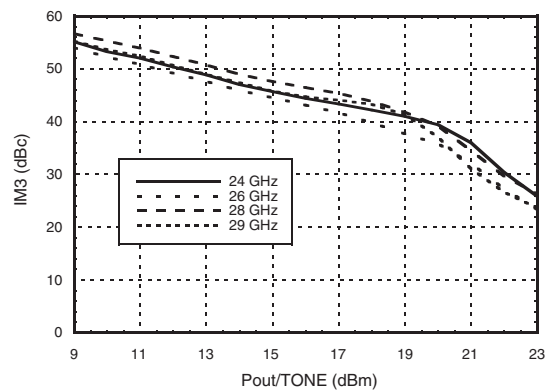

Output Power, Gain & PAE @ 27 GHz

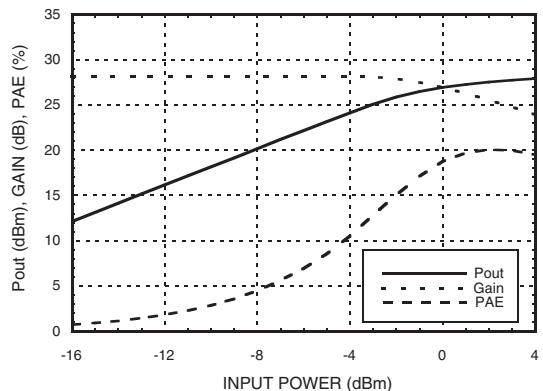

Reverse Isolation vs. Temperature

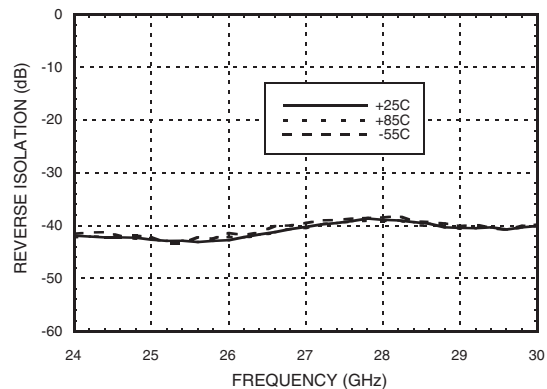

**GaAs pHEMT MMIC 1/2 WATT
POWER AMPLIFIER, 24 - 29.5 GHz**

**Gain & Power vs.
Supply Current @ 27 GHz**

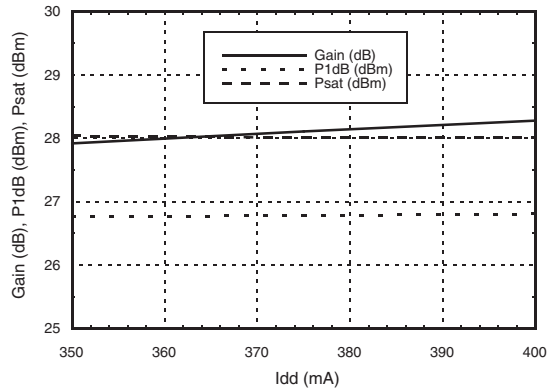

**Gain & Power vs.
Supply Voltage @ 27 GHz**

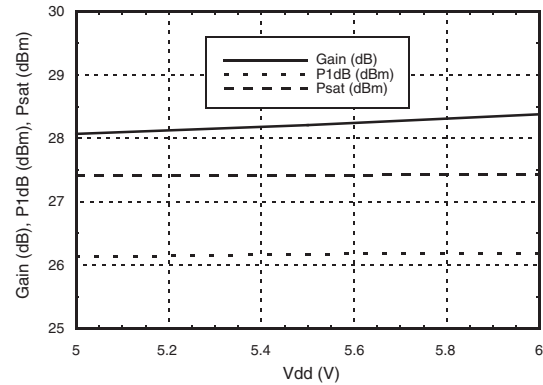

Power Dissipation

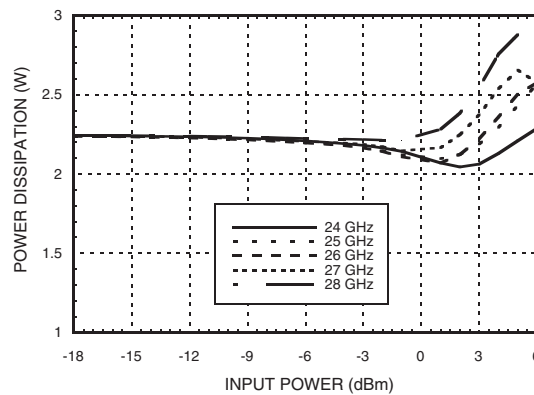

Absolute Maximum Ratings

Drain Bias Voltage (Vdd)	+6.5V
RF Input Power (RFIN)	+26 dBm
Channel Temperature	150 °C
Continuous Pdiss (T= 85 °C) (derate 37.2 mW/°C above 85 °C)	2.42W
Thermal Resistance (channel to die bottom)	26.9 °C/W
Storage Temperature	-65 to 150 °C
Operating Temperature	-55 to +85 °C

Typical Supply Current vs. Vdd

Vdd (V)	Idd (mA)
+5.0	375
+5.5	375
+6.0	375

Note: Amplifier will operate over full voltage ranges shown above Vgg adjusted to achieve Idd = 375mA at +5.5V



**ELECTROSTATIC SENSITIVE DEVICE
OBSERVE HANDLING PRECAUTIONS**

**GaAs pHEMT MMIC 1/2 WATT
POWER AMPLIFIER, 24 - 29.5 GHz**

Outline Drawing

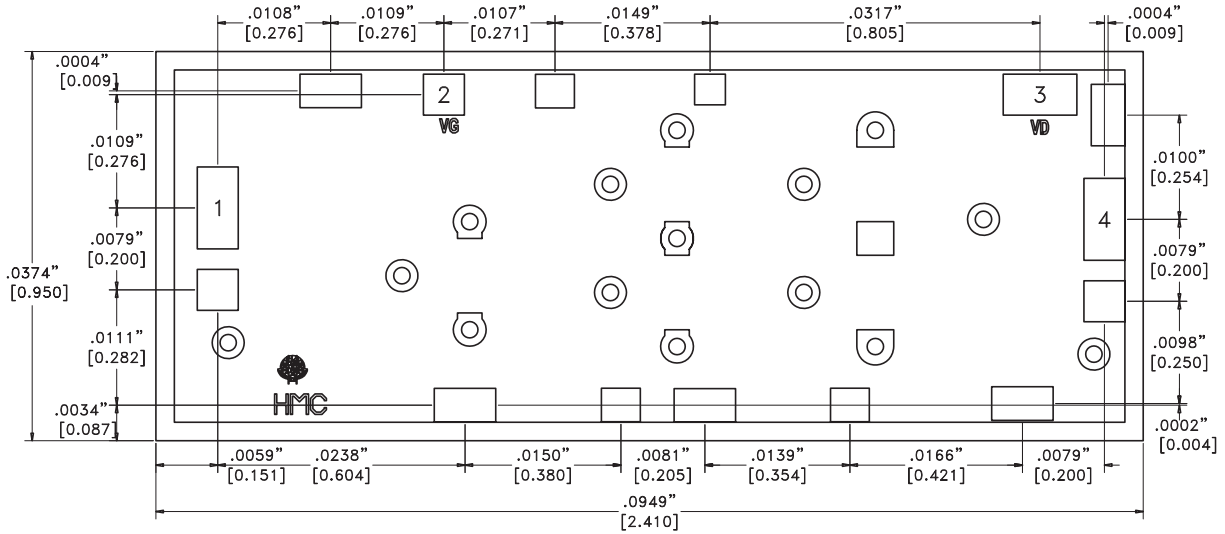

Die Packaging Information [1]

Standard	Alternate
GP-2 (Gel Pack)	[2]



[1] Refer to the "Packaging Information" section for die packaging dimensions.

[2] For alternate packaging information contact Hittite Microwave Corporation.

NOTES:

1. ALL DIMENSIONS ARE IN INCHES [MM]
2. DIE THICKNESS IS .004"
3. TYPICAL BOND PAD IS .004" SQUARE
4. BACKSIDE METALLIZATION: GOLD
5. BOND PAD METALLIZATION: GOLD
6. BACKSIDE METAL IS GROUND.
7. CONNECTION NOT REQUIRED FOR UNLABELED BOND PADS.
8. OVERALL DIE SIZE ± .002

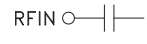
Pad Descriptions

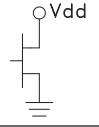
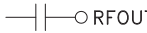
Pad Number	Function	Description	Interface Schematic
1	RFIN	This pad is AC coupled and matched to 50 Ohms.	
2	Vgg	Gate control for PA. Adjust Vgg to achieve recommended bias current. External bypass caps 100pF, 0.1 μF and 4.7 μF are required.	
3	Vdd	Drain bias for amplifier. External bypass caps 100pF, 0.1 μF and 4.7uF are required	
4	RFOUT	This pad is AC coupled and matched to 50 Ohms.	

**GaAs pHEMT MMIC 1/2 WATT
 POWER AMPLIFIER, 24 - 29.5 GHz**

Assembly Diagram

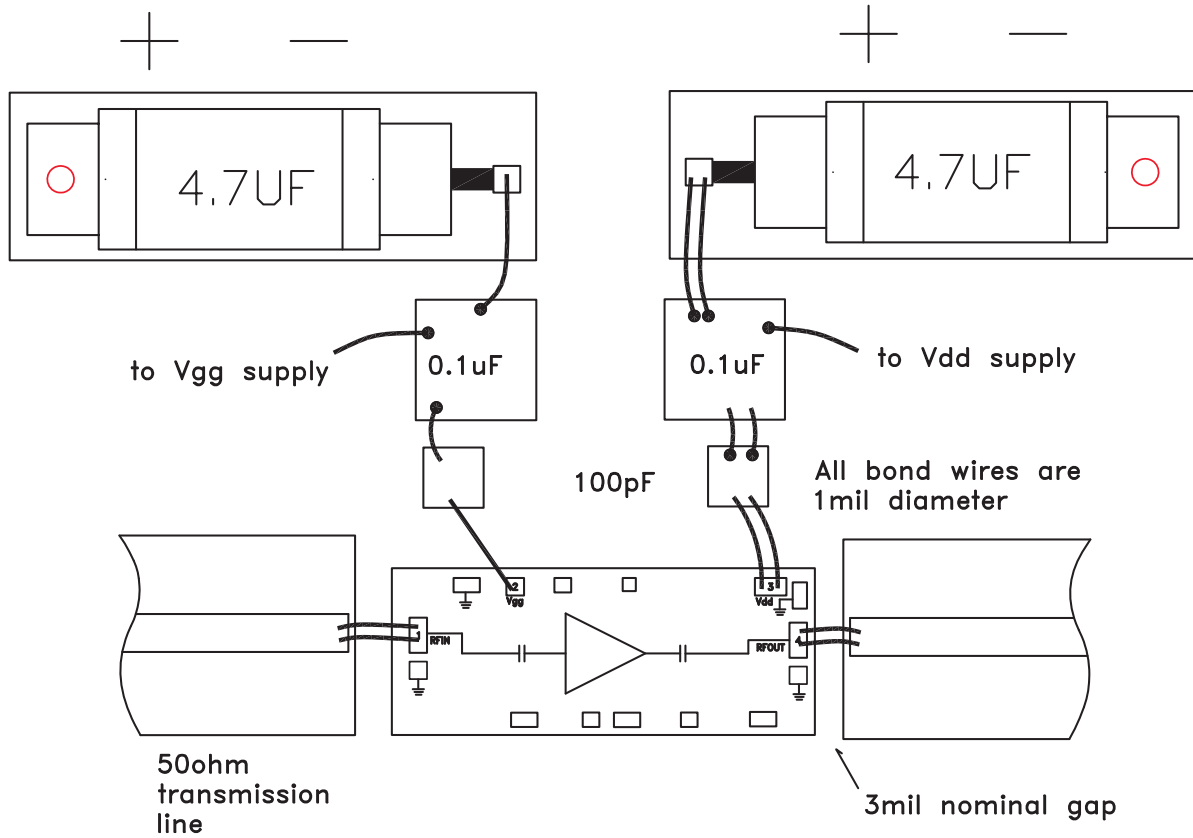

**GaAs pHEMT MMIC ½ WATT
POWER AMPLIFIER, 24 - 29.5 GHz**

Mounting & Bonding Techniques for Millimeterwave GaAs MMICs

The die should be attached directly to the ground plane eutectically or with conductive epoxy (see HMC general Handling, Mounting, Bonding Note).

50 Ohm Microstrip transmission lines on 0.127mm (5 mil) thick alumina thin film substrates are recommended for bringing RF to and from the chip (Figure 1). If 0.254mm (10 mil) thick alumina thin film substrates must be used, the die should be raised 0.150mm (6 mils) so that the surface of the die is coplanar with the surface of the substrate. One way to accomplish this is to attach the 0.102mm (4 mil) thick die to a 0.150mm (6 mil) thick molybdenum heat spreader (moly-tab) which is then attached to the ground plane (Figure 2).

Microstrip substrates should be located as close to the die as possible in order to minimize bond wire length. Typical die-to-substrate spacing is 0.076mm to 0.152 mm (3 to 6 mils).

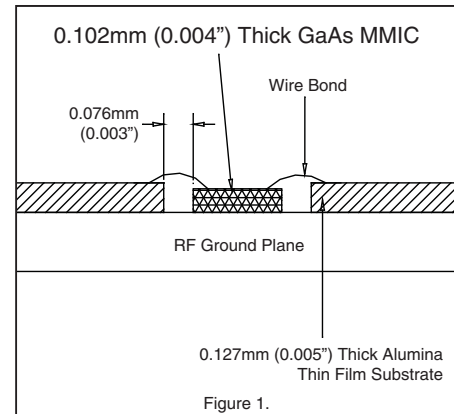

Handling Precautions

Follow these precautions to avoid permanent damage.

Storage: All bare die are placed in either Waffle or Gel based ESD protective containers, and then sealed in an ESD protective bag for shipment. Once the sealed ESD protective bag has been opened, all die should be stored in a dry nitrogen environment.

Cleanliness: Handle the chips in a clean environment. DO NOT attempt to clean the chip using liquid cleaning systems.

Static Sensitivity: Follow ESD precautions to protect against > ± 250V ESD strikes.

Transients: Suppress instrument and bias supply transients while bias is applied. Use shielded signal and bias cables to minimize inductive pick-up.

General Handling: Handle the chip along the edges with a vacuum collet or with a sharp pair of bent tweezers. The surface of the chip may have fragile air bridges and should not be touched with vacuum collet, tweezers, or fingers.

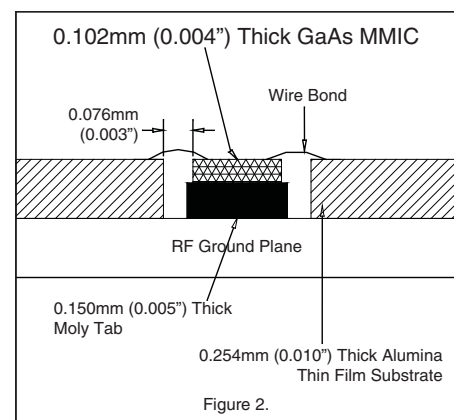

Mounting

The chip is back-metallized and can be die mounted with AuSn eutectic preforms or with electrically conductive epoxy. The mounting surface should be clean and flat.

Eutectic Die Attach: A 80/20 gold tin preform is recommended with a work surface temperature of 255 °C and a tool temperature of 265 °C. When hot 90/10 nitrogen/hydrogen gas is applied, tool tip temperature should be 290 °C. DO NOT expose the chip to a temperature greater than 320 °C for more than 20 seconds. No more than 3 seconds of scrubbing should be required for attachment.

Epoxy Die Attach: Apply a minimum amount of epoxy to the mounting surface so that a thin epoxy fillet is observed around the perimeter of the chip once it is placed into position. Cure epoxy per the manufacturer's schedule.

Wire Bonding

Ball or wedge bond with 0.025mm (1 mil) diameter pure gold wire. Thermosonic wirebonding with a nominal stage temperature of 150 °C and a ball bonding force of 40 to 50 grams or wedge bonding force of 18 to 22 grams is recommended. Use the minimum level of ultrasonic energy to achieve reliable wirebonds. Wirebonds should be started on the chip and terminated on the package or substrate. All bonds should be as short as possible <0.31mm (12 mils).