

**4...20 mA Output • Hazardous Area Certification**  
**Ranges: 0-45° to 0-240°**  
**Industrial Grade**



# IT9420

## Specification Summary:

### GENERAL

Available Full Stroke Ranges ..... 0-45 to 0-240 degrees  
 Weight (aluminum enclosure)..... 5 lb. typical (aluminum enclosure)  
 Enclosure Material.....aluminum (stainless steel available)  
 Sensor ..... precision potentiometer  
 Electrical Connector..... MS3102E-14S-6P  
 Mating Plug (included) ..... MS3106E-14S-6S

### ELECTRICAL

Output Signal ..... 4...20 mA  
 Input Voltage ..... *see ordering information*  
 Input Current..... 20 mA max.  
 Circuit Protection..... 38 mA maximum

### PERFORMANCE

Sensitivity..... 16 mA/full stroke,  $\pm 0.25\%$   
 Accuracy\*.....  $\pm 1\%$  full stroke  
 Accuracy Option ..... 0.5% full stroke—*please contact factory*  
 Resolution ..... essentially infinite  
 Output Signal Adjustment for Full Stroke Ranges of 45° - 105°:  
 Zero Adjustment ..... from factory set zero to 20% of full stroke range  
 Span Adjustment..... to 20% of factory set span  
 Output Signal Adjustment for Full Stroke Ranges of 120° - 240°:  
 Zero Adjustment ..... from factory set zero to 40% of full stroke range  
 Span Adjustment..... to 40% of factory set span  
 \*—when plane of pendulum motion parallel to plane of rotation within  $\pm 3^\circ$

### ENVIRONMENTAL

Enclosure ..... NEMA 4/4X/6, IP 67/68  
 Hazardous Area Certification ..... *see ordering information*  
 Operating Temperature ..... -30° to 200°F (-34° to 90°C)  
 Vibration..... up to 10 G's to 2000 Hz maximum

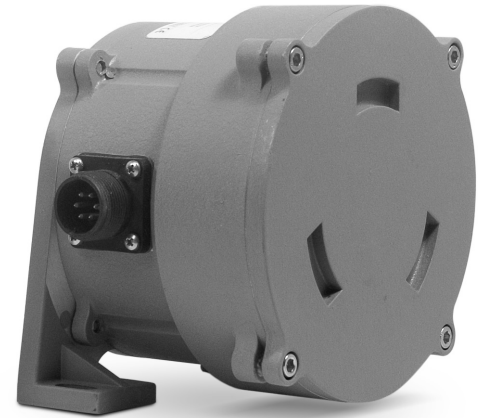

The model IT9420 is a rugged yet simple device which provides a 4 to 20 mA current feedback signal for incline position. The heart of the IT9420 is a magnetically-damped pendulum coupled to a conductive plastic precision potentiometer. A highly linear relationship between inclination and a 4 to 20 mA output is maintained over the full range of the IT9420.

The IT9420 is easy to use: simply attach it to the object of measurement and install two wires for the current loop.

### Outline Drawing

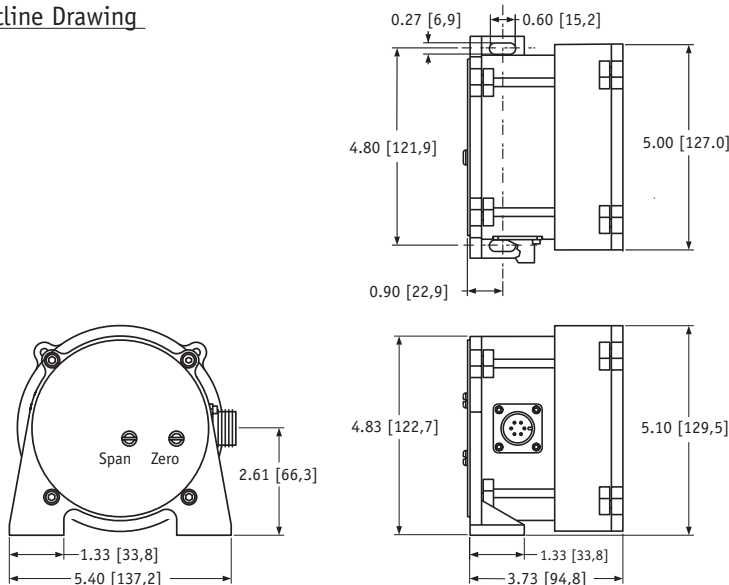

DIMENSIONS ARE IN INCHES [MM] tolerances are  $\pm 0.02$  in. [ $\pm 0.5$  mm] unless otherwise specified

CeleSCO Transducer Products, Inc.

20630 Plummer Street • Chatsworth, CA 91311

tel: 800.423.5483 • +1.818.701.2750 • fax: +1.818.701.2799

### Output Signal

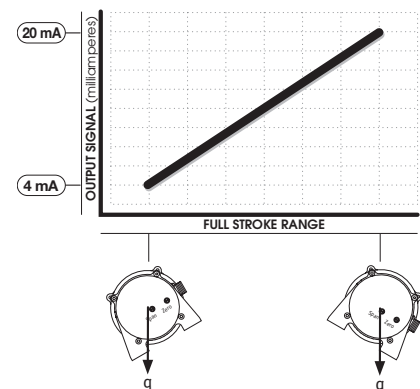

**celesco**

celesco.com • info@celesco.com

**Ordering Information:**

**Model Number:**

**IT9420** - \_\_\_\_\_ - \_\_\_\_\_ - \_\_\_\_\_ - \_\_\_\_\_ - \_\_\_\_\_  
 order code:                      CW                      CCW                      A                      B                      C                      D

Sample Model Number:  
**IT9420 - 060 - 120 - 1110**

- CW** clockwise rotation: 60°
- CCW** counter-clockwise rotation: 120° } total rotation = 180°
- A** enclosure: aluminum
- B** output signal: 4 mA @ 120° CCW  
20 mA @ 60° CW
- C** electrical connection: 6-pin plastic connector
- D** magnetic dampening: yes

**Full Clockwise Rotation:**

<b>CW</b> order code:	<b>000</b>	<b>015</b>	<b>030</b>	<b>045</b>	<b>060</b>	<b>075</b>	<b>090</b>	<b>105</b>	<b>120</b>
	0°	15°	30°	45°	60°	75°	90°	105°	120°

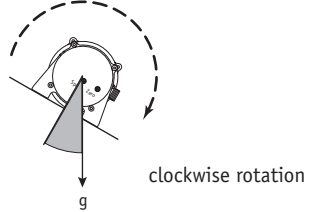

**Important--**  
 the sum of the Clockwise and Counter-Clockwise Rotations must be in the range of 45° to 240°

**Full Counter-Clockwise Rotation:**

<b>CCW</b> order code:	<b>000</b>	<b>015</b>	<b>030</b>	<b>045</b>	<b>060</b>	<b>075</b>	<b>090</b>	<b>105</b>	<b>120</b>
	0°	15°	30°	45°	60°	75°	90°	105°	120°

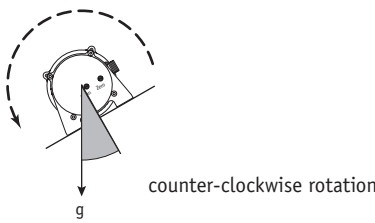

**Important--**  
 the sum of the Clockwise and Counter-Clockwise Rotations must be in the range of 45° to 240°

**Enclosure Material:**

<b>A</b> order code:	<b>1</b>	<b>2</b>
	powder-painted aluminum	303 stainless steel



**Output Signal:**

<b>B</b> order code:	<b>1</b>	<b>2</b>	<b>5</b>	<b>6</b>
output signal options:	4...20 mA	20...4 mA	4...20 mA	20...4 mA
input voltage:	8 – 34 vdc		14 – 32 vdc	
hazardous area certification:	not certified		CSA Standard 22.2 Class 1 Groups A, B, C and D	Cenelec LCIE EEx ia IIC T4

**\*IMPORTANT:** intrinsically safe when powered from a CSA certified zener barrier rated 28 VDC max, 110 mA max per installation drawing#677984

**Ordering Information:**

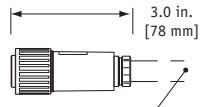
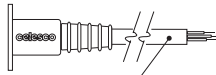
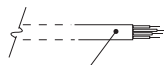
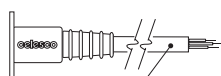
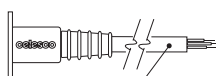
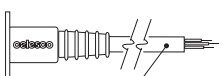
**Electrical Connection:**

<p>① <i>order code:</i></p> <p><b>1</b></p> <p>6-pin plastic connector w/mating plug <b>IP 67, NEMA 4X** , 6</b></p>  <p>1/2 - 5/16" [14 - 8 mm] cable dia. 16 AWG max conductor size connector: MS3102E-14S-6P mating plug: MS3106E-14S-6S</p>	<p><b>2</b></p> <p>10-ft. [3 M] waterproof cable <b>IP 67, NEMA 4X** , 6</b></p>  <p>10 ft. x 0.4-in. dia. [3 M x 10 mm dia.] 18 AWG, type SJTW</p>	<p><b>4</b></p> <p>25-ft. [7.5 M] instrumentation cable <b>IP 67, NEMA 6</b></p>  <p>25 ft. x 0.2-in. dia. [7,5 M x 5 mm dia.] 24 AWG, shielded</p>																												
<p>② <i>order code:</i></p> <p><b>5</b></p> <p>100-ft. [30 M] waterproof cable <b>IP 67, NEMA 4X** , 6</b></p>  <p>100 ft. x 0.4-in. dia. [30 M x 10 mm dia.] 18 AWG, type SJTW</p>	<p><b>6</b></p> <p>10-ft. [3 M] pressure tested* waterproof cable <b>IP 68, NEMA 4X** , 6P</b></p>  <p>10 ft. x 0.4-in. dia. [3 M x 10 mm dia.] 18 AWG, type SJTW</p>	<p><b>7</b></p> <p>100-ft. [30 M] pressure tested* waterproof cable <b>IP 68, NEMA 4X** , 6P</b></p>  <p>100 ft. x 0.4-in. dia. [30 M x 10 mm dia.] 18 AWG, type SJTW</p>																												
<p><b>6-pin Mating Plug</b></p> <table border="1"> <tr><th>pin</th><th>signal</th></tr> <tr><td>A</td><td>8...34 vdc</td></tr> <tr><td>B</td><td>4...20 mA out</td></tr> <tr><td>C</td><td>-</td></tr> <tr><td>D</td><td>case ground</td></tr> </table>  <p>contact view</p>	pin	signal	A	8...34 vdc	B	4...20 mA out	C	-	D	case ground	<p><b>Waterproof Cable</b></p> <table border="1"> <tr><th>color code</th><th>signal</th></tr> <tr><td>WHITE</td><td>8...34 vdc</td></tr> <tr><td>BLACK</td><td>4...20 mA out</td></tr> <tr><td>GREEN</td><td>case ground</td></tr> </table>	color code	signal	WHITE	8...34 vdc	BLACK	4...20 mA out	GREEN	case ground	<p><b>Instrumentation Cable</b></p> <table border="1"> <tr><th>color code</th><th>2-wire</th></tr> <tr><td>RED</td><td>8...34 vdc</td></tr> <tr><td>BLACK</td><td>4...20 mA out</td></tr> <tr><td>WHITE</td><td>n/a</td></tr> <tr><td>GREEN</td><td>case ground</td></tr> </table>	color code	2-wire	RED	8...34 vdc	BLACK	4...20 mA out	WHITE	n/a	GREEN	case ground
pin	signal																													
A	8...34 vdc																													
B	4...20 mA out																													
C	-																													
D	case ground																													
color code	signal																													
WHITE	8...34 vdc																													
BLACK	4...20 mA out																													
GREEN	case ground																													
color code	2-wire																													
RED	8...34 vdc																													
BLACK	4...20 mA out																													
WHITE	n/a																													
GREEN	case ground																													

\*-Test pressure: 100 feet [30 meters] H<sub>2</sub>O (40 PSID) Test Medium: Air; Duration: 2 hours. \*\* -applies to stainless steel enclosure only.



**Dampening Option:**

<p>① <i>order code:</i></p> <p><b>0</b></p> <p>with magnetic dampening</p>	<p><b>1</b></p> <p>without magnetic dampening</p>
--	---

**Output Signal Selection:**

The output signal direction can be reversed at any time by simply changing the dip-switch settings found on the internal signal board. After the settings have been changed, adjustment of the Zero and Span trim pots will be required to precisely match the 4 mA and 20mA signal values to the beginning and end points of the stroke.

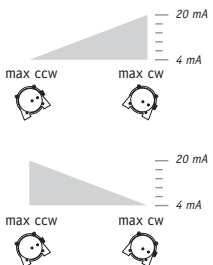
To gain access to the signal board, remove four Allen-Head Screws and remove end cover bracket.

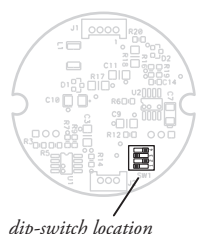
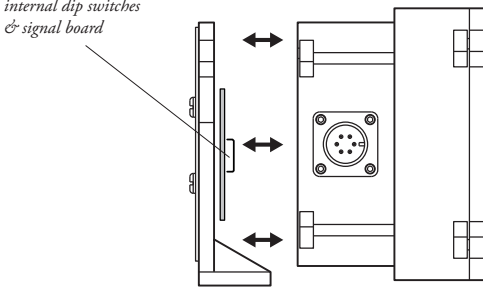
<p><i>output signal</i></p> 	<p><i>switch setting</i></p> 	<p><i>signal board</i></p>  <p>dip-switch location</p>	<p><i>internal dip switches &amp; signal board</i></p> 
---	--	---	---

version: 4.0 last updated: May 21, 2013

