

# PT420

**Instrument Grade • 4..20mA / 0..20mA**

**Absolute Linear Position • Classic Stringpot Design**  
**Stroke Range Options: 0–2 to 0–100 inches**  
**Powder Painted & Anodized Aluminum Enclosure**  
**Industrial Automation & Testing Applications**

## GENERAL

Full Stroke Range Options	0-2 to 0-100 inches
Output Signal Options	4...20 mA (2-wire) and 0...20 mA (3-wire)
Accuracy	see ordering information
Repeatability	± 0.05% full stroke
Resolution	essentially infinite
Enclosure Material	powder-painted and anodized aluminum
Sensor	plastic-hybrid precision potentiometer
Weight	2 lbs. max.

## ELECTRICAL

Input Voltage	see ordering information
Input Current	20 mA max.
Maximum Loop Resistance (Load)	(loop supply voltage - 8)/0.020
Circuit Protection	38 mA max.
Impedance	100M ohms@100 VDC, min.
Signal Adjustment, Zero	from factory set zero to 50% of full stroke range
Signal Adjustment, Span	to 50% of factory set span
Thermal Effects, Zero	0.01% f.s./°F, max.
Thermal Effects, Span	0.01% f.s./°F, max.

## ENVIRONMENTAL

Enclosure	IP50, NEMA 1
Operating Temperature	-40° to 200°F (-40° to 90°C)
Vibration	up to 10 g to 2000 Hz maximum

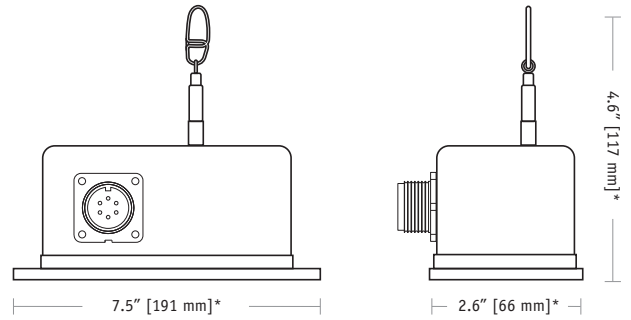

\*50-inch range model, dimensions may differ for other ranges

The PT420 is available with full-scale measurement ranges from 2 to 100 inches, providing a 0/4-20 mA feedback signal that is linearly proportional to the position of a traveling stainless-steel extension cable. Use the PT420 to provide position feedback on hydraulic cylinders in factories and utilities, gate position in fresh or wastewater distribution systems, or valve opening in process-related applications.

The PT420 installs in minutes by mounting its base to a fixed surface and attaching its cable to the movable object. The PT420 works without perfect parallel alignment, and when its stainless steel cable is retracted, its height is less than 5".

## Electrical Output Signal

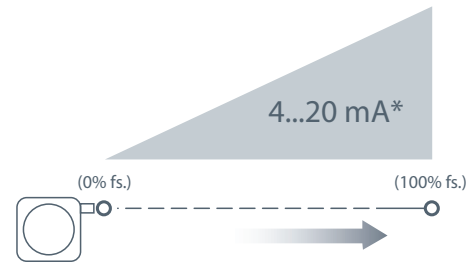

\*Optional 3-wire, 0...20mA output signal available.

Fig. 1, Top Exit:

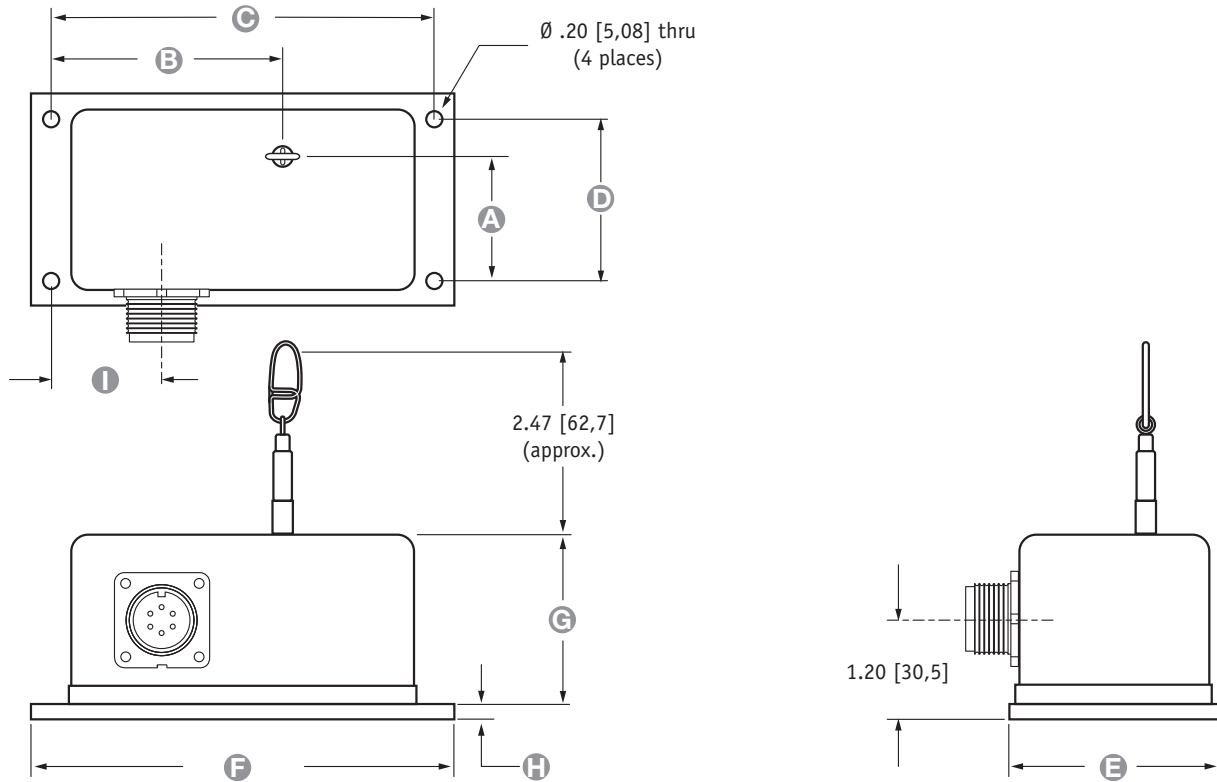

ALL DIMENSIONS ARE IN INCHES [MM] • tolerances are ±0.02 in. [±0,5mm]

Range	A	B	C	D	E	F	G	H	I
2", 10", 20"	1.34 [34,0]	4.00 [101,6]	7.00 [177,8]	2.00 [50,8]	2.63 [66,8]	7.50 [190,5]	2.10 [53,3]	.16 [4,1]	1.37 [34,8]
5", 25", 50"	1.83 [46,5]	4.00 [101,6]	7.00 [177,8]	2.00 [50,8]	2.63 [66,8]	7.50 [190,5]	2.10 [53,3]	.16 [4,1]	1.37 [34,8]
15", 30"	1.56 [39,6]	4.00 [101,6]	7.00 [177,8]	2.00 [50,8]	2.63 [66,8]	7.50 [190,5]	2.10 [53,3]	.16 [4,1]	1.37 [34,8]
40"	1.64 [41,6]	4.00 [101,6]	7.00 [177,8]	2.00 [50,8]	2.63 [66,8]	7.50 [190,5]	2.10 [53,3]	.16 [4,1]	1.37 [34,8]
60"	2.16 [54,9]	4.19 [106,4]	7.00 [177,8]	2.37 [60,2]	3.25 [82,5]	7.50 [190,5]	2.60 [66,0]	.19 [4,8]	1.37 [34,8]
75", 80"	2.45 [62,2]	4.38 [111,3]	6.75 [171,4]	2.50 [63,5]	3.63 [92,2]	7.50 [190,5]	2.86 [72,6]	.19 [4,8]	1.37 [34,8]
100"	3.10 [78,7]	4.19 [106,4]	7.38 [187,5]	3.00 [76,2]	4.25 [108,0]	8.00 [203,2]	3.79 [96,3]	.19 [4,8]	3.69 [93,7]

Ordering Information:

Model Number:

**PT420** -      -      **1** - **1** - **0**  
order code:      R      A      B      C      D      E      F      G

Sample Model Number:

**PT420 - 0025 - 111 - 1110**

- R** range: 25 inches
- A** measuring cable tension: standard - 5 oz.
- C** cable exit: top
- E** output signal: 4...20 mA
- F** electrical connection: 6-pin plastic connector

Full Stroke Range:

<b>R</b> order code:	0002	0005	0010	0015	0020	0025	0030	0040	0050	0060	0075	0100
full stroke range, min:	2 in.	5 in.	10 in.	15 in.	20 in.	25 in.	30 in.	40 in.	50 in.	60 in.	75 in.	100 in.
accuracy (% of f.s.):	0.28%	0.28%	0.18%	0.18%	0.15%	0.18%	0.15%	0.15%	0.15%	0.15%	0.15%	0.15%
potentiometer cycle life*:	2.5 x 10 <sup>6</sup>	2.5 x 10 <sup>6</sup>	5 x 10 <sup>5</sup>	5 x 10 <sup>5</sup>	5 x 10 <sup>5</sup>	5 x 10 <sup>5</sup>	5 x 10 <sup>5</sup>	2.5 x 10 <sup>5</sup>	2.5 x 10 <sup>5</sup>	2.5 x 10 <sup>5</sup>	2.5 x 10 <sup>5</sup>	2.5 x 10 <sup>5</sup>

\*-1 cycle is defined as the travel of the measuring cable from full retraction to full extension and back to full retraction

Ordering Information (cont.):

**Measuring Cable Tension:**



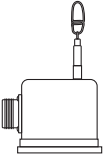
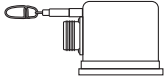
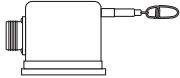
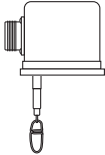

	1		H		2*		3*	
	standard tension		high tension		*note – outline dimensions for these options are not controlled on this datasheet!			
	tension, ±20%	max acceleration	tension, ±40%	max acceleration				
2, 10, 20 inch range:	12 oz.	• 11 g	65 oz.	• 53 g	72 oz.		144 oz.	
5, 25, 50 inch range:	5 oz.	• 2 g	26 oz.	• 11 g	30 oz.		60 oz.	
15, 30 inch range:	8 oz.	• 3 g	43 oz.	• 23 g	48 oz.		96 oz.	
40 inch range:	6 oz.	• 4 g	33 oz.	• 16 g	36 oz.		72 oz.	
60 inch range:	13 oz.	• 4 g	22 oz.	• 8 g	26 oz.		52 oz.	
75, 80 inch range:	10 oz.	• 3 g	31 oz.	• 12 g	20 oz.		40 oz.	
100 inch range:	13 oz.	• 5 g	52 oz.	• 20 g	26 oz.		52 oz.	
measuring cable:	.019-in. dia. nylon-coated stainless steel				.024-in. dia. stainless steel			

**Measuring Cable Exit:**

order code:	1	2	3	4
	top exit (see fig. 1)	front exit*	rear exit*	bottom exit*
				

\*-note: dimensions for optional cable exits not controlled on this datasheet, please contact factory



**Sensing Circuit:**

order code:	1	2	3	4
output signal options:	4...20 mA 	20...4 mA 	0...20 mA 	20...0 mA 
sensitivity:	16 mA/full stroke ±0.25%		20 mA/full stroke ±0.25%	
wiring configuration:	2 – wire		3 – wire	
input voltage:	8 – 34 VDC		14 – 29 VDC	

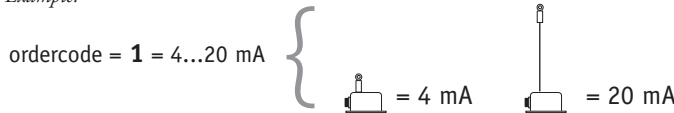
Example:

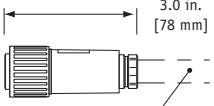
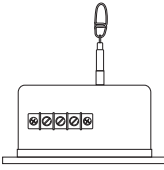
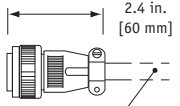

**Electrical Connection:**

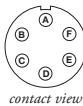
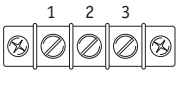
order code:	1	2	3	4																																									
	6-pin plastic connector with mating plug	terminal strip	6-pin metal connector with mating plug	25-ft. instrumentation cable 24 AWG, shielded																																									
	 3.0 in. [78 mm]		 2.4 in. [60 mm]																																										
	1/2 - 5/16" [14 - 8 mm] cable dia. 16 AWG max conductor size connector: MS3102E-14S-6P mating plug: MS3106E-14S-6S		3/8-in. [9 mm] max cable dia. 16 AWG max conductor size connector: MS3102E-14S-6P mating plug: MS3106E-14S-6S	25 ft. x 0.2-in. dia. [7.5 M x 5 mm dia.] 24 AWG, shielded																																									
	<b>6-pin mating plug:</b>	<b>Terminal Strip:</b>		<b>25-ft. instrumentation cable:</b>																																									
	<table border="0"> <tr> <td>pin</td> <td>2-wire</td> <td>3-wire</td> </tr> <tr> <td>A</td> <td>8...34 vdc</td> <td>14...29 vdc</td> </tr> <tr> <td>B</td> <td>4...20 mA out</td> <td>common</td> </tr> <tr> <td>C</td> <td>-</td> <td>0...20 mA out</td> </tr> <tr> <td>D</td> <td>case ground</td> <td>-</td> </tr> </table>	pin	2-wire	3-wire	A	8...34 vdc	14...29 vdc	B	4...20 mA out	common	C	-	0...20 mA out	D	case ground	-	<table border="0"> <tr> <td>terminal</td> <td>2-wire</td> <td>3-wire</td> </tr> <tr> <td>1</td> <td>8...34 vdc</td> <td>14...29 vdc</td> </tr> <tr> <td>2</td> <td>4...20 mA out</td> <td>common</td> </tr> <tr> <td>3</td> <td>case ground</td> <td>0...20 mA out</td> </tr> </table>	terminal	2-wire	3-wire	1	8...34 vdc	14...29 vdc	2	4...20 mA out	common	3	case ground	0...20 mA out	<table border="0"> <tr> <td>color code</td> <td>2-wire</td> <td>3-wire</td> </tr> <tr> <td>RED</td> <td>8...34 vdc</td> <td>14...29 vdc</td> </tr> <tr> <td>BLACK</td> <td>4...20 mA out</td> <td>common</td> </tr> <tr> <td>WHITE</td> <td>n/a</td> <td>n/a</td> </tr> <tr> <td>GREEN</td> <td>case ground</td> <td>0...20 mA out</td> </tr> </table>	color code	2-wire	3-wire	RED	8...34 vdc	14...29 vdc	BLACK	4...20 mA out	common	WHITE	n/a	n/a	GREEN	case ground	0...20 mA out
pin	2-wire	3-wire																																											
A	8...34 vdc	14...29 vdc																																											
B	4...20 mA out	common																																											
C	-	0...20 mA out																																											
D	case ground	-																																											
terminal	2-wire	3-wire																																											
1	8...34 vdc	14...29 vdc																																											
2	4...20 mA out	common																																											
3	case ground	0...20 mA out																																											
color code	2-wire	3-wire																																											
RED	8...34 vdc	14...29 vdc																																											
BLACK	4...20 mA out	common																																											
WHITE	n/a	n/a																																											
GREEN	case ground	0...20 mA out																																											
	 contact view																																												

Output Signal Selection:

The output signal direction can be reversed at any time by simply changing the dip-switch settings found on the internal signal board. After the settings have been changed, adjustment of the Zero and Span trimpots will be required to precisely match signal values to the beginning and end points of the stroke.

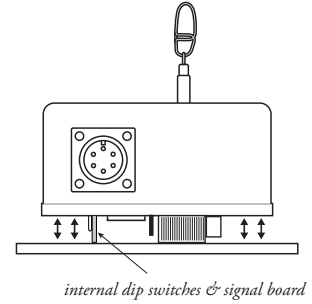
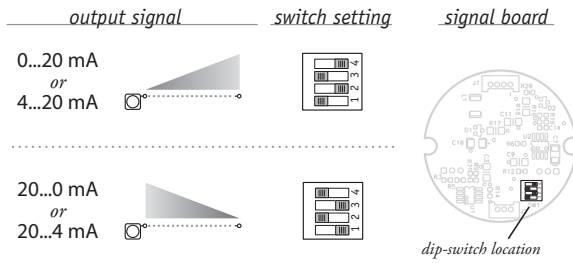

To gain access to the signal board, remove the two 4-40 screws on top and lift up cover.

version: 8.0 last updated: May 21, 2013