

SG01D-18

Broadband SiC based UV photodiode A = 0,50 mm²



GENERAL FEATURES



Properties of the SG01D-18 UV photodiode

- Broadband UVA+UVB+UVC, PTB reported high chip stability
- Active Area A = 0,50 mm²
- TO18 hermetically sealed metal housing, 1 isolated pin and 1 case pin
- 10mW/cm² peak radiation results a current of approx. 6500 nA

About the material Silicon Carbide (SiC)

SiC provides the unique property of extreme radiation hardness, near-perfect visible blindness, low dark current, high speed and low noise. These features make SiC the best available material for visible blind semiconductor UV detectors. The SiC detectors can be permanently operated at up to 170°C (338°F). The temperature coefficient of signal (responsivity) is also low, < 0,1%/K. Because of the low noise (dark current in the fA range), very low UV radiation intensities can be measured reliably. Please note that this device needs an appropriate amplifier (see typical circuit on page 3).

Options

SiC photodiodes are available with five different active chip areas from 0,06 mm² up to 4,00 mm². Standard version is broadband UVA-UVB-UVC. Four filtered versions lead to a tighter sensitivity range. All photodiodes have a hermetically sealed metal housing (TO type), either a 5,5 mm diameter TO18 housing or a 9,2 mm TO5 housing. Further option is either a 2 pin header (1 isolated, 1 grounded) or a 3 pin header (2 isolated, 1 grounded).

NOMENCLATURE

SG01			
S, M, D, L, XL	nothing, A, B, C or E	18, 18ISO90, 18S, 5, 5ISO90	nothing, Lens, MEGA, GIGA
Chip area	Spectral response	Housing	Special
S 0,06 mm ²	nothing = broadband $\lambda_{\max} = 280 \text{ nm}$ $\lambda_{S10\%} = 221 \text{ nm} \dots 358 \text{ nm}$	18 2-pin TO18 housing, h = 5,2 mm, 1 pin isolated, 1 pin grounded	Lens with concentrating lens, TO5 only
M 0,20 mm ²	A = UVA $\lambda_{\max} = 331 \text{ nm}$ $\lambda_{S10\%} = 309 \text{ nm} \dots 367 \text{ nm}$	18ISO90 3-pin TO18 housing, h = 5,2 mm, 2 pins isolated, 1 pin grounded	
D 0,50 mm ²	B = UVB $\lambda_{\max} = 280 \text{ nm}$ $\lambda_{S10\%} = 231 \text{ nm} \dots 309 \text{ nm}$	18S 2-pin TO18 housing, h = 3,7 mm, 1 pin isolated, 1 pin grounded	MEGA with attenuator up to 0,5 W/cm ²
L 1,00 mm ²	C = UVC $\lambda_{\max} = 275 \text{ nm}$ $\lambda_{S10\%} = 225 \text{ nm} \dots 287 \text{ nm}$	5 2-pin TO5 housing, h = 4,3 mm for broadband; h = 6,7 mm for filtered UVA, UVB, UVC, UVI	GIGA with attenuator up to 7 W/cm ²
XL 4,00 mm ²	E = UV-Index spectral response according to CIE087	5ISO90 3-pin TO5 housing, h = 4,2 mm, 2 pins isolated, 1 pin grounded	

SG01D-18

Broadband SiC based UV photodiode A = 0,50 mm²



SPECIFICATIONS

Parameter	Symbol	Value	Unit
Spectral Characteristics			
Typical Responsivity at Peak Wavelength	S_{peak}	0,130	AW ⁻¹
Wavelength of max. Spectral Responsivity	λ_{max}	280	nm
Responsivity Range ($S=0,1 \cdot S_{max}$)	-	221 ... 358	nm
Visible Blindness ($S_{max}/S_{>405nm}$)	VB	> 10 ¹⁰	-
General Characteristics (T=25°C)			
Active Area	A	0,50	mm ²
Dark Current (1V reverse bias)	I_d	1,7	fA
Capacitance	C	125	pF
Short Circuit (10mW/cm ² at peak)	I_o	6500	nA
Temperature Coefficient	T_c	< 0,1	%/K
Maximum Ratings			
Operating Temperature	T_{opt}	-55 ... +170	°C
Storage Temperature	T_{stor}	-55 ... +170	°C
Soldering Temperature (3s)	T_{sold}	260	°C
Reverse Voltage	V_{Rmax}	20	V

NORMALIZED SPECTRAL RESPONSIVITY

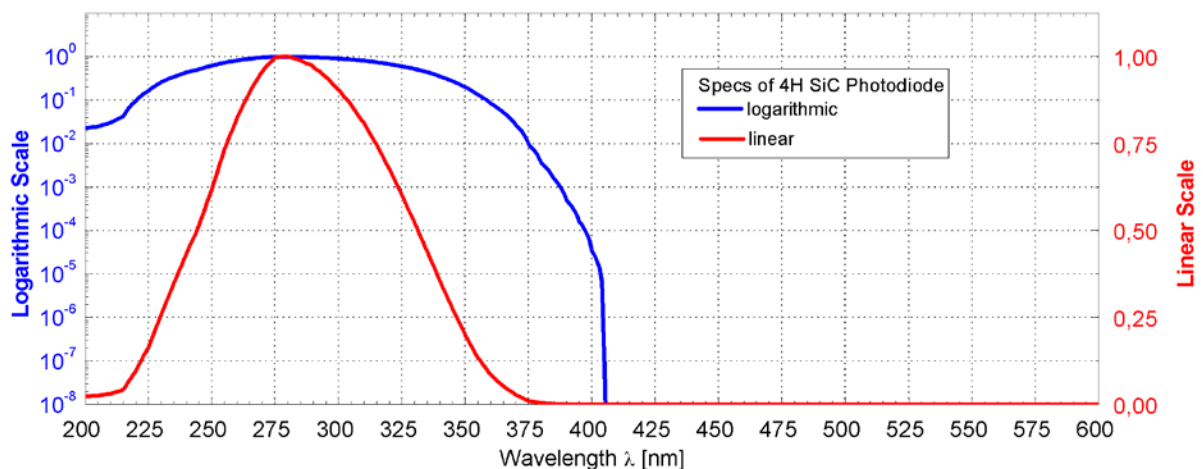

SG01D-18

Broadband SiC based UV photodiode A = 0,50 mm²

FIELD OF VIEW

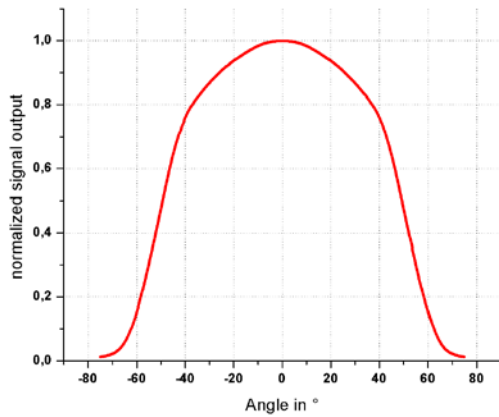

Measurement Setup:

lamp aperture diameter: 10 mm
 distance lamp aperture to second aperture: 17 mm
 second aperture diameter: 10 mm
 distance second aperture to detector: 93 mm

pivot level = top surface of the photodiode window

TYPICAL CIRCUIT

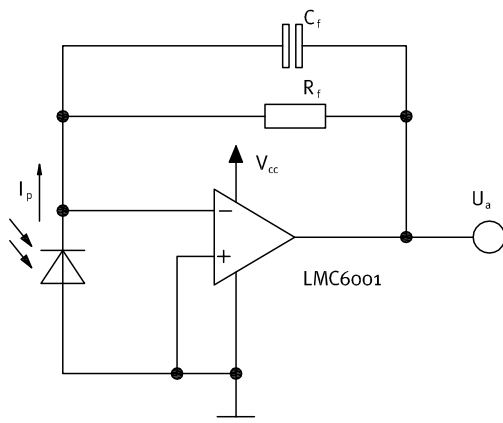

Calculations and Limits:

$$U_a = I_p \times R_f = 0 \dots \sim V_{cc}$$

$U_{a,max}$ depends on load and amplifier type

$R_f = 10k\Omega \dots \sim 10G\Omega$, $C_f \geq 3pF$
 Recommendation: $R_f \times C_f \geq 10^{-3}s$

$$I_{p,max} = U_{a,max} \div R_f$$

$$\text{Bandwidth} = DC \dots \frac{1}{2\pi \times R_f \times C_f}$$

Example:

$$I_p = 20nA, R_f = 100M\Omega, C_f = 100 pF$$

$$U_a = 20 \times 10^{-9}A \times 100 \times 10^6\Omega = 2V$$

DRAWINGS

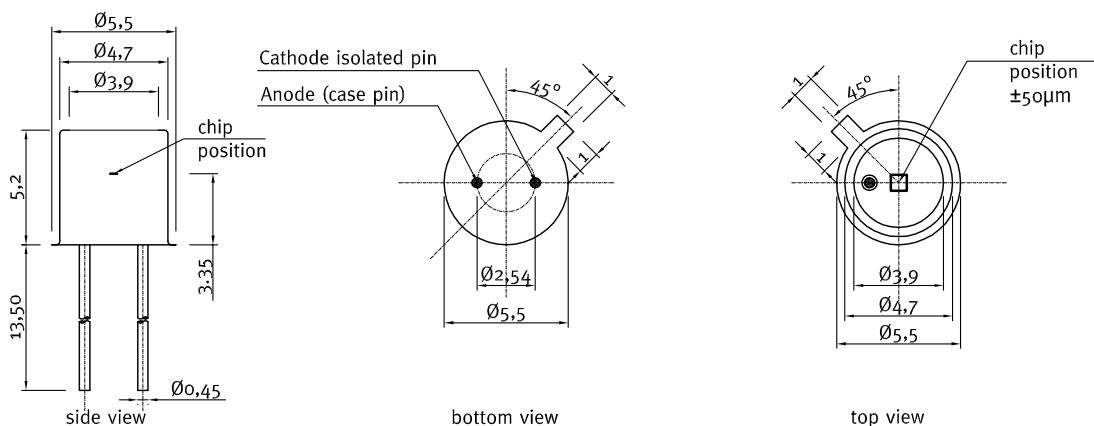

SG01D-18

Broadband SiC based UV photodiode A = 0,50 mm²

APPLICATION NOTE FOR PHOTODIODES

For correct reading of the photodiode the current (and NOT the voltage) must be analyzed. This requires a short circuiting of the photodiode. Usual approaches are using a **Picoamperemeter** or a **transimpedance amplifier** circuit as shown on page 3.

UPGRADE TO A TOCON OR A PROBE

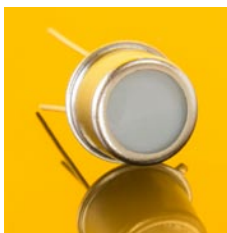

TOCONs = UV sensors with integrated amplifier

- SiC based UV hybrid detector with amplifier (0–5V output), no additional amplifier needed, direct connection to controller, voltmeter, etc.
- Measures intensities from 1,8 pW/cm² up to 18 W/cm²
- UV broadband, UVA, UVB, UVC or Erythema measurements



Miniature housing with M12x1 thread for the TOCON series

- Optional feature for all TOCON detectors
- Robust stainless steel M12x1 thread body
- Integrated sensor connector (Binder 5-Pin plug) with 2m connector cable
- Easy to mount and connect



Industrial UV probes

- Different housings e.g. with cosine response, water pressure proof or sapphire windows
- Different electronic outputs configurable (voltage, current, USB, CAN)
- Good EMC safety for industrial applications

CALIBRATION SERVICE



- Different NIST and PTB traceable calibrations and measurements for all sglux sensors
- Calibration of sensors for irradiation measurements
- Calibration of UV sensors on discrete wavelengths
- Determination of a specific spectral sensor responsivity