

# Infrared Radiation Source JSIR350-4-AL-R-D6.0-0-0

Fast radiation source with reflector for use with thermopiles and pyroelectric detectors in NDIR gas analysis and other applications.

Spectral Output Range <sup>1</sup>	typ. 1 ... 20	μm
Active Area	2.2 x 2.2	mm <sup>2</sup>
Hot Resistant	40±20	Ω
Temperature Coefficient	typ. 650	ppm/K
Time Constant	typ. 15	ms
Nominal Power Consumption	0.65	W
Operation Voltage <sup>2</sup>	typ. 4.9	V
Operation Current <sup>2</sup>	typ. 132	mA
Active Area Temperature <sup>3,5</sup>	640	°C
Window	-	
Mass	~1	g
Housing	T039 (modified)	
Lifetime <sup>4</sup>	> 5,000 h at 740°C > 100,000 h at 640°C	

<sup>1</sup> without window

<sup>2</sup> with 40Ω

<sup>3</sup> at nominal power (0.65W)

<sup>4</sup> at 10 Hz, 50% duty cycle, preliminary results

<sup>5</sup> at T<sub>amb</sub> = 25°C

The current data are based on simulations and tests. They are subject to change during the next evaluation steps.



## Pin Assignment

Bottom View

Pin 1 Power

Pin 2 Case

Pin 3 Power

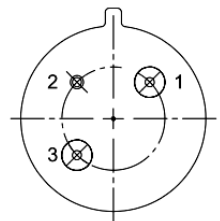

## Absolute Max. Ratings

Power 1.2 W

Housing temperature 200 °C

Active Area Temperature 850 °C

**Micro-Hybrid Electronic GmbH**

Heinrich-Hertz-Straße 8  
D-07629 Hermsdorf

Tel.: +49 366 01 592 100  
Fax: +49 366 01 592 110

Email: [Infrared@micro-hybrid.de](mailto:Infrared@micro-hybrid.de)  
Web: [www.micro-hybrid.de](http://www.micro-hybrid.de)

**LIVING MICROWORLDS.**

# Infrared Radiation Source JSIR350-4-AL-R-D6.0-0-0

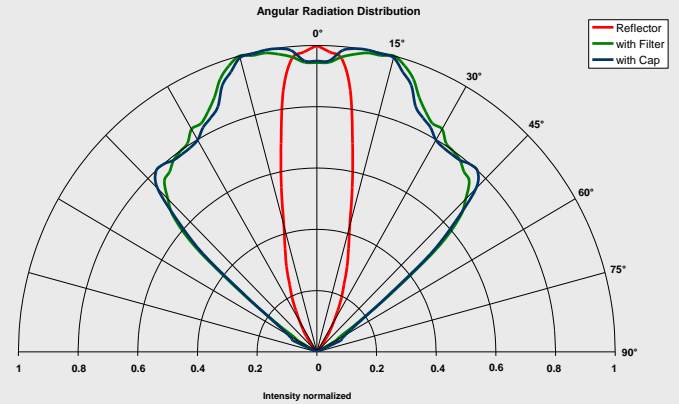
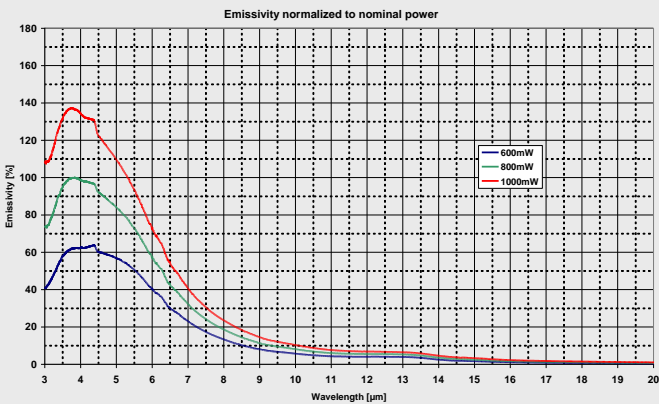
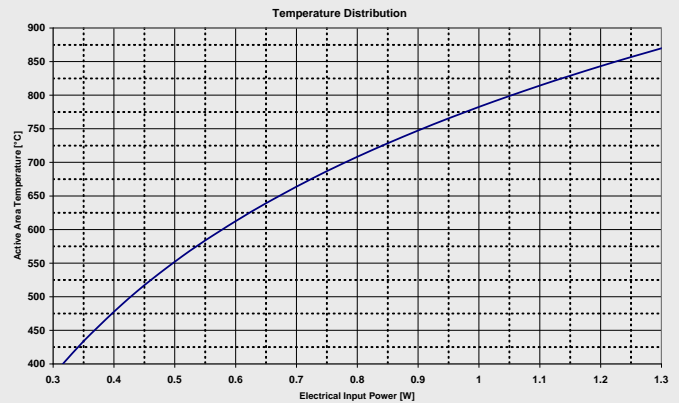
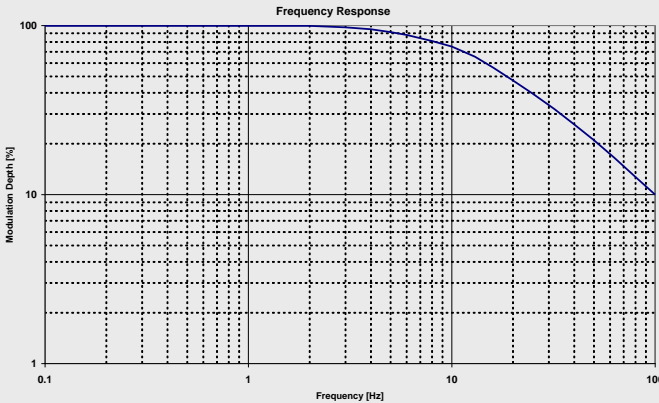

## Housing

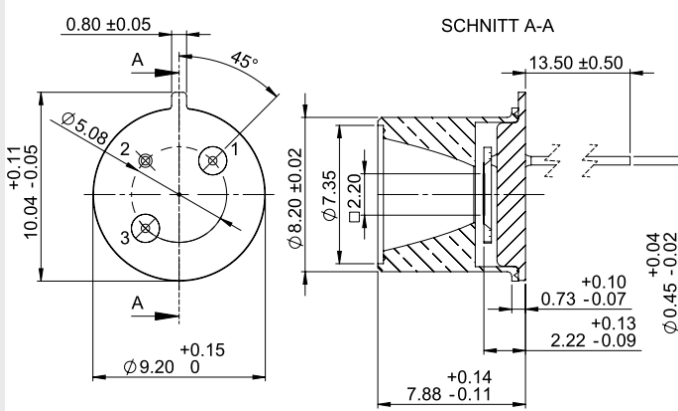

## Operation range

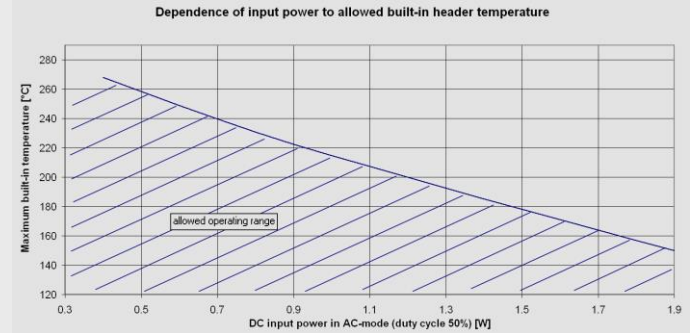

## Optional parts

Window – For hermetic sealing and / or spectral narrowing of the radiation

Evaluation Kit – For independent evaluation of emitters and detectors

**Micro-Hybrid Electronic GmbH**

**Heinrich-Hertz-Straße 8  
D-07629 Hermsdorf**

**Tel.: +49 366 01 592 100  
Fax: +49 366 01 592 110**

**Email: [Infrared@micro-hybrid.de](mailto:Infrared@micro-hybrid.de)  
Web: [www.micro-hybrid.de](http://www.micro-hybrid.de)**

**LIVING MICROWORLDS.**