

Infrared Radiation Source JSIR350-5-BL-C-D2.55-0-0

Very fast radiation source for use with thermopiles and pyroelectric detectors in NDIR gas analysis and other applications.

Spectral Output Range ¹	typ. 1 ... 15	μm
Active Area	0.65 x 0.65	mm ²
Hot Resistant	40±20	Ω
Temperature Coefficient	typ. 650	ppm/K
Time Constant	typ. 7	ms
Nominal Power Consumption	0.175	W
Operation Voltage ²	typ. 2.8	V
Operation Current ²	typ. 63	mA
Active Area Temperature ^{3,5}	640	°C
Window	-	
Mass	~1	g
Housing	T046 (modified)	
Lifetime ⁴	> 5,000 h at 740°C > 100,000 h at 640°C	

¹ without window

² with 40Ω

³ at nominal power (0.2W)

⁴ at 10 Hz, 50% duty cycle, preliminary results

⁵ at T_{amb} = 25°C

The current data are based on simulations and tests. They are subject to change during the next evaluation steps.



Pin Assignment

Bottom View

Pin 1 Power

Pin 2 Case

Pin 3 Power

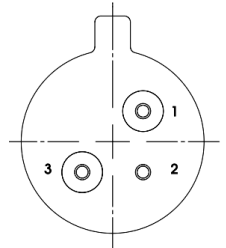

Absolute Max. Ratings

Power 0.3 W

Housing temperature 200 °C

Active Area Temperature 800 °C

Micro-Hybrid Electronic GmbH

Heinrich-Hertz-Straße 8
D-07629 Hermsdorf

Tel.: +49 366 01 592 100
Fax: +49 366 01 592 110

Email: Infrared@micro-hybrid.de
Web: www.micro-hybrid.de

LIVING MICROWORLDS.

Infrared Radiation Source JSIR350-5-BL-C-D2.55-0-0

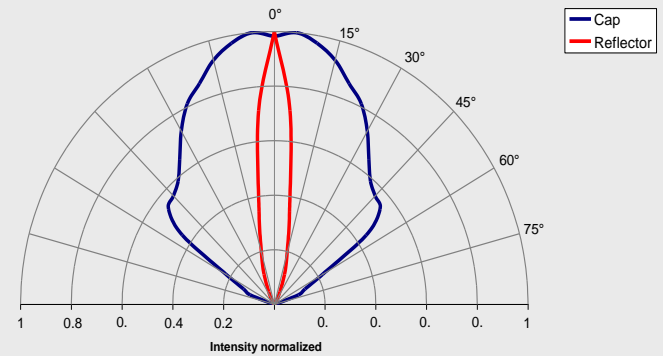
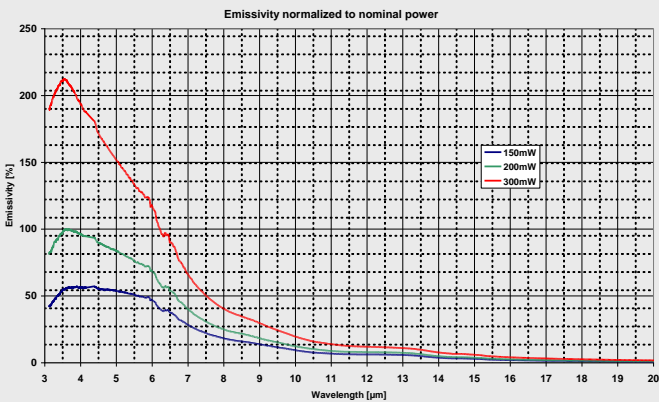
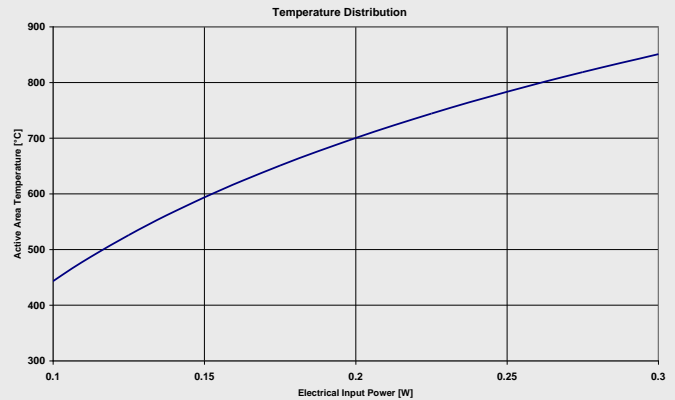
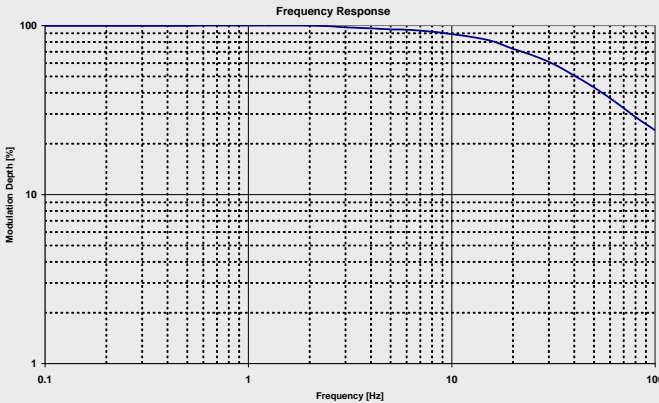

Housing

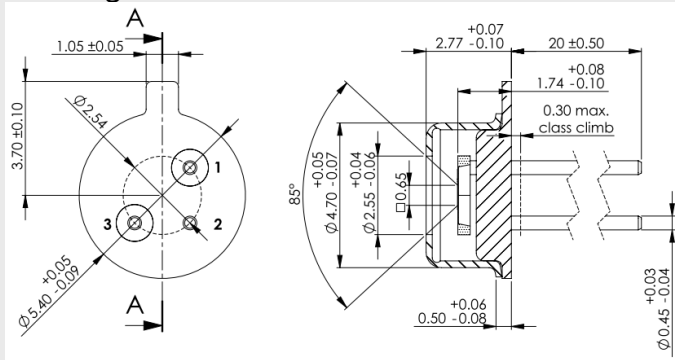

Operation range

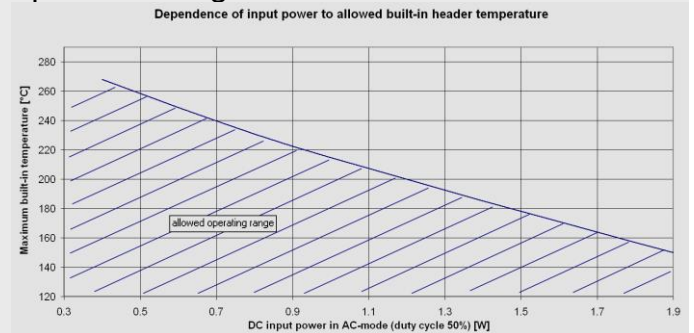

Optional parts

Window – For hermetic sealing and / or spectral narrowing of the radiation

Evaluation Kit – For independent evaluation of emitters and detectors

Micro-Hybrid Electronic GmbH

**Heinrich-Hertz-Straße 8
D-07629 Hermsdorf**

**Tel.: +49 366 01 592 100
Fax: +49 366 01 592 110**

**Email: Infrared@micro-hybrid.de
Web: www.micro-hybrid.de**

LIVING MICROWORLDS.