

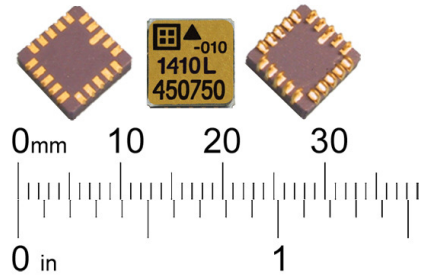

- Digital Pulse Density Output
- Drop-In Replacement for Model 1010
- Integrated Sensor & Amplifier
- -55 to +175 °C Operation
- +5 VDC, 2 mA Power (typical)
- LCC or J-Lead Surface Mount Package
- Responds to DC & AC Acceleration
- No External Reference Voltage
- Capacitive Micromachined
- Easy Interface to Microprocessors
- Nitrogen Damped
- Hermetically Sealed
- Serialized for Traceability
- TTL/CMOS Compatible
- Good EMI Resistance
- RoHS Compliant



Available G-Ranges

| Full Scale Acceleration | 20 pin LCC | 20 pin JLCC |
|-------------------------|------------|-------------|
| ± 2 g | 1410L-002 | 1410J-002 |
| ± 5 g | 1410L-005 | 1410J-005 |
| ± 10 g | 1410L-010 | 1410J-010 |
| ± 25 g | 1410L-025 | 1410J-025 |
| ± 50 g | 1410L-050 | 1410J-050 |
| ±100 g | 1410L-100 | 1410J-100 |
| ±200 g * | 1410L-200 | 1410J-200 |

* Recommended for Down Hole Drilling

DESCRIPTION

The Model 1410 is an integrated accelerometer for use in zero to medium frequency instrumentation applications. Each miniature, hermetically sealed package combines a micro-machined capacitive sense element and a custom integrated circuit that includes a sense amplifier and sigma-delta A/D converter. It is relatively insensitive to temperature changes and gradients. Each device is marked with a serial number on its bottom surface for traceability. An optional calibration test sheet (1410-TST) is also available which lists the measured bias, scale factor, linearity, operating current and frequency response.

OPERATION

The Model 1410 produces a digital pulse train in which the density of pulses (number of pulses per second) is proportional to applied acceleration. It requires a single +5 volt power supply and a TTL/CMOS level clock of 100kHz-1MHz. The output is ratiometric to the clock frequency and independent of the power supply voltage. Two forms of digital signals are provided for direct interfacing to a microprocessor or counter. The sensitive axis is perpendicular to the bottom of the package, with positive acceleration defined as a force pushing on the bottom of the package. External digital line drivers can be used to drive long cables or when used in an electrically noisy environment.

APPLICATIONS

- Automotive
 - Air Bags
 - Active Suspension
 - Adaptive Brakes
 - Security Systems
- Shipping Recorders
- Appliances
- Vibration Monitoring
- Vibration Analysis
- Machine Control
- Modal Analysis
- Robotics
- Crash Testing
- Instrumentation

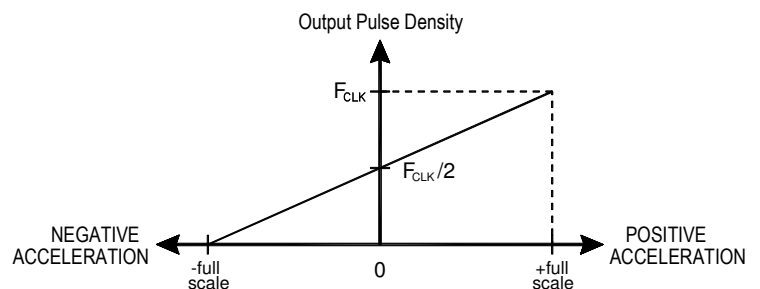

SPECIFICATIONS SUBJECT TO CHANGE WITHOUT NOTICE

Silicon Designs, Inc. • 13905 NE 128th Street, Kirkland WA 98034 • Phone: 425-391-8329 • Fax: 425-391-0446

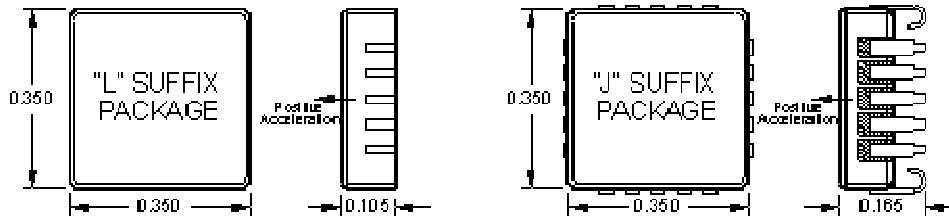

PERFORMANCE - By Model: $V_{DD}=V_R=5.0$ VDC, $F_{CLK}=250$ kHz, $T_C=25^\circ$ C

| MODEL NUMBER | UNITS | 1410-002 | 1410-005 | 1410-010 | 1410-025 | 1410-050 | 1410-100 | 1410-200 |
|---|-------|----------|----------|----------|----------|----------|-----------|-----------|
| Input Range | g | ± 2 | ± 5 | ± 10 | ± 25 | ± 50 | ± 100 | ± 200 |
| Frequency Response (Nominal, 3 dB) ¹ | Hz | 0 - 400 | 0 - 600 | 0 - 1000 | 0 - 1400 | 0 - 1600 | 0 - 1800 | 0 - 2000 |
| Sensitivity, Differential ² | kHz/g | 62.5 | 25.0 | 12.5 | 5.0 | 2.50 | 1.25 | .625 |
| Max. Mechanical Shock (0.1 ms) | g | 2000 | | | 5000 | | | |

PERFORMANCE - All Models: Unless otherwise specified $V_{DD}=V_R=5.0$ VDC, $F_{CLK}=250$ kHz, $T_C=25^\circ$ C

| PARAMETER | MIN | TYP | MAX | UNITS |
|--|---------------|------|--------------|---------------------------------|
| Cross Axis Sensitivity | | 2 | 3 | % |
| Bias Calibration Error ¹ | | .5 | 1 | % of F_{CLK} (span) |
| Bias Temperature Shift ($T_C=-55$ to $+125^\circ$ C) ¹ | | 100 | 300 | (ppm of F_{CLK})/ $^\circ$ C |
| Scale Factor Calibration Error ^{1,2} | | 0.5 | 1 | % |
| Scale Factor Temperature Shift ($T_C=-55$ to $+125^\circ$ C) ¹ | | +300 | | ppm/ $^\circ$ C |
| Non-Linearity (-90 to +90% of Full Scale) ^{1,2} | -002 thru 100 | 0.5 | 1.0 | % of span |
| | -200 | 0.7 | 1.5 | |
| Power Supply Rejection Ratio ($V_{DD}=V_R$) | 40 | | | dB |
| Operating Voltage (V_{DD} vs. GND) | 4.5 | 5.0 | 5.5 | Volts |
| Operating Current ($I_{DD}+I_{VR}$) ¹ | | 2 | 3 | mA |
| Clock Input Voltage Range (with respect to GND) | 0.5 | | $V_{DD}+0.5$ | Volts |
| Mass 'L' Package (add 0.06 grams for 'J' package) | | 0.62 | | Grams |

Note 1: Tighter tolerances may be available on special order.
 Note 2: 100g and greater versions are tested from -65 to +65g.

SIGNAL DESCRIPTIONS

VDD and GND (power): Pin 14 (VDD) & pin 19 (GND). Additionally tie pins 3 & 11 to VDD & pins 2, 5, 6 & 18 to GND.

CLK (input): Pin 8. Reference clock input. This hysteresis threshold input must be driven by a 50% duty cycle square wave signal. Factory Calibration is performed at 250 kHz, which is the recommended clock frequency for best results. Operation at frequencies as low as 100 kHz or as high as 1 MHz are possible, however a slight bias shift may result.

CNT (output): Pin 10. Count output. A return-to-zero type digital pulse stream whose pulse width is equal to the input CLK logic high time. The CNT pulse rate increases with positive acceleration. The device experiences positive (+1g) acceleration with its lid facing up in the earth's gravitational field. This signal is meant to drive an up-counter directly.

DIR and DIR (output): Pins 12 & 16 respectively. Direction output. This output is updated at the fall of each clock cycle. It is high during clock cycles when a high going CNT pulse is present and low during cycles when no CNT pulse is present. A non- return-to-zero signal meant to control the count direction (i.e. up or down) of a counter. DIR can be low pass filtered to produce an analog measure of the acceleration. DIR is the complement of DIR and is provided for use in driving differential transmission lines.

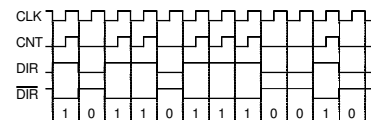

DV (input): Pin 4. Deflection Voltage. Normally left open. A test input that applies an electrostatic force to the sense element, simulating a positive acceleration. The nominal voltage at this pin is $\frac{1}{3}V_{DD}$. DV voltages higher than required to bring the output to positive full scale may cause device damage.

VR (input): Pin 3. Voltage Reference. Tie directly to V_{DD} (+5V). A 0.1 μ F bypass capacitor is recommended at this pin.

CLK/2 (output): Pin 15. Clock divided by 2. A buffered clock output whose frequency equals CLK divided by 2.

SPECIFICATIONS SUBJECT TO CHANGE WITHOUT NOTICE

**ABSOLUTE MAXIMUM RATINGS ***

| | |
|--|--------------------------------|
| Case Operating Temperature | -55 to +175°C |
| Storage Temperature | -55 to +125°C |
| Acceleration Over-range | 2000g for 0.1 ms |
| Voltage on V _{DD} to GND | -0.5V to 6.5V |
| Voltage on Any Pin (except DV) to GND ³ | -0.5V to V _{DD} +0.5V |
| Voltage on DV to GND ⁴ | ±15V |
| Power Dissipation | 20 mW |

Note 3: Voltages on pins other than DV, GND or V_{DD} may exceed 0.5 volt above or below the supply voltages provided the current is limited to 1 mA.

Note 4: The application of DV voltages higher than required to bring the output to positive full scale may cause device damage.

* **NOTICE:** Stresses greater than those listed above may cause permanent damage to the device. These are stress ratings only. Functional operation of the device at or above these conditions is not implied. Exposure to absolute maximum rating conditions for extended periods may affect device reliability and lifespan.

DC CHARACTERISTICS: V_{DD}=V_R=5.0 VDC, T_C= 55 to +125°C

| SYMBOL | PARAMETER | MIN | TYP | MAX | UNITS | TEST CONDITIONS |
|----------------------------------|--|-----------------------|-----|-----|-------|---------------------------------------|
| V _{T-} | Negative Going Threshold Voltage (CLK) | 0.9 | 1.7 | | V | |
| V _{T+} | Positive Going Threshold Voltage (CLK) | | 3.0 | 3.7 | V | |
| V _H | Hysteresis Voltage (CLK) | 0.5 | 1.3 | | V | |
| V _{OL} | Output Low Voltage (CNT, DIR, CLK/2) | | | 0.4 | V | I _{OL} = 2.0 mA |
| V _{OH} | Output High Voltage (CNT, DIR, CLK/2) | V _{DD} - 0.4 | | | V | I _{OH} = 2.0 mA |
| I _I | Input Leakage Current (CLK) | | | 10 | µA | V _I = 0 to V _{DD} |
| C _{IO} | Pin Capacitance | | | 10 | pF | 1 MHz, T _A = 25°C |
| I _{DD} +I _{VR} | Operating Current | | 2 | 3 | mA | F _{CLK} = 250kHz |

AC CHARACTERISTICS: V_{DD}=V_R=5.0 VDC, T_C= -55 to +125°C, Load Capacitance=50pF.

| PARAMETER | MIN | TYP | MAX | UNITS |
|-----------------------------|-----|-----|------|-------|
| CLK input frequency | 100 | 250 | 1000 | kHz |
| CLK input rise/fall time | | | 50 | ns |
| CLK duty cycle | 45 | 50 | 55 | % |
| CLK fall to DIR fall | 40 | 85 | 195 | ns |
| CLK fall to DIR rise | 40 | 90 | 205 | ns |
| CLK rise to valid CNT out | 40 | 90 | 230 | ns |
| CLK fall to CNT fall | 40 | 85 | 205 | ns |
| CLK fall to CLK/2 rise/fall | 40 | 90 | 210 | ns |

SPECIFICATIONS SUBJECT TO CHANGE WITHOUT NOTICE

Silicon Designs, Inc. • 13905 NE 128th Street, Kirkland WA 98034 • Phone: 425-391-8329 • Fax: 425-391-0446

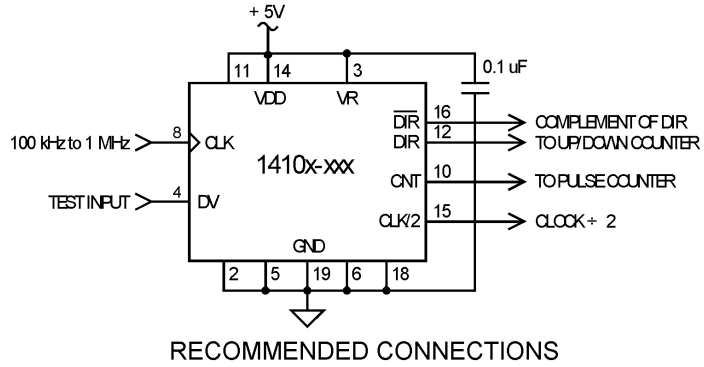
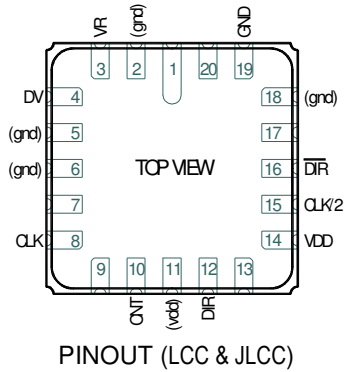

USING THE COUNT (CNT) OUTPUT: Pulses from the CNT output are meant to be accumulated in a hardware counter. Each pulse accumulation or sample, reflects the average acceleration (change in velocity) over that interval. The sample period or “gate time” over which these pulses are accumulated determines both the bandwidth and quantization of the measurement.

$$\text{Quantization (g's)} = \frac{g_{SPAN} \cdot f_{SR}}{f_{CLK}}$$

$$f_{CNT} = f_{CLK} \left(\frac{1}{2} + \frac{g_{FORCE}}{g_{SPAN}} \right)$$

$$g_{FORCE} = g_{SPAN} \left(\frac{f_{CNT}}{f_{CLK}} - \frac{1}{2} \right)$$

Where:

- $g_{SPAN} = 2*$ (full scale acceleration in g's)
- f_{SR} = CNT sample rate in Hertz
- f_{CLK} = accelerometer clock rate in Hertz
- f_{CNT} = CNT pulse rate in pulses/sec
- g_{FORCE} = acceleration in gravity units
- $1 g^* = 9.807 \text{ m/s}^2 \text{ or } 32.18 \text{ ft/s}^2$

*Value reflects location of Silicon Designs facility.

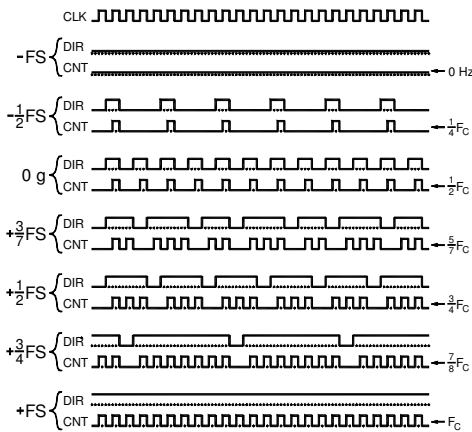

minus full scale (-FS) to plus full scale (+FS).

DEFLECTION VOLTAGE (DV) TEST INPUT: This test input applies an electrostatic force to the sense element, simulating a positive acceleration. It has a nominal input impedance of 32 kΩ and a nominal open circuit voltage of $\frac{1}{3}V_{DD}$. For best accuracy during normal operation, this input should be left unconnected or connected to a voltage source equal to $\frac{1}{3}$ of the V_{DD} supply. The change in output pulse rate (Δf) is proportional to the square of the difference between the voltage applied to the DV input (V_{DV}) and $\frac{1}{3}V_{DD}$. Only positive shifts in the output pulse rate may be generated by applying voltage to the DV input. When voltage is applied to the DV input, it should be applied gradually. The application of DV voltages greater than required to bring the output to positive full scale may cause device damage. The proportionality constant (k) varies for each device and is not characterized.

$$\Delta f \approx k \left(V_{DV} - \frac{1}{3} V_{DD} \right)^2$$



Model 1410

ESD and LATCH-UP CONSIDERATIONS: The model 1410 accelerometer is a CMOS device subject to damage from large electrostatic discharges. Diode protection is provided on the inputs and outputs but care should be exercised during handling to assure that the device is placed only on a grounded conductive surface. Individuals and tools should be grounded before coming in contact with the device. Do not insert the model 1410 into (or remove it from) a powered socket.

LCC & JLCC SOLDER CONTACT PLATING INFORMATION: The plating composition and thickness for the solder pads and castellations on the "L" suffix (LCC) package are 60 to 225 micro-inches thick of gold (Au) over 80 to 350 micro-inches thick of nickel (Ni) over a minimum of 5 micro-inches thick of molybdenum or tungsten refractory material. The leads for the "J" suffix (JLCC) package are made of an Iron-Nickel sealing alloy and have the same gold over nickel plating thicknesses as for the LCC pads.

| DIM | Inch | mm |
|-----|------|-------|
| A | .230 | 5.84 |
| B | .430 | 10.92 |
| C | .100 | 2.54 |
| D | .033 | 0.84 |
| E | .050 | 1.27 |
| F | .013 | 0.33 |
| G | .120 | 3.05 |

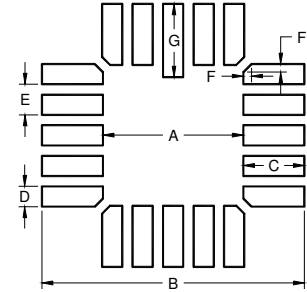

RECOMMENDED SOLDER PAD PATTERN: The recommended solder pad size and shape for both the LCC and J LCC packages is shown in the diagram and table below. These dimensions are recommendations only and may or may not be optimum for your particular soldering process.

PACKAGE DIMENSIONS

Notes:

- *Dimensions 'M', 'T' & 'U' locate acceleration sensing element's center of mass.
- Lid is electrically tied to terminal 19 (GND).
- Controlling dimension: inch.
- Terminals are plated with 60 micro-inches min gold over 80 micro-inches min nickel. (This plating specification does not apply to the metallized pin-1 identifier mark on the bottom of the j-lead version of the package).
- Package: 90% minimum alumina (black), lid: solder sealed kovar.

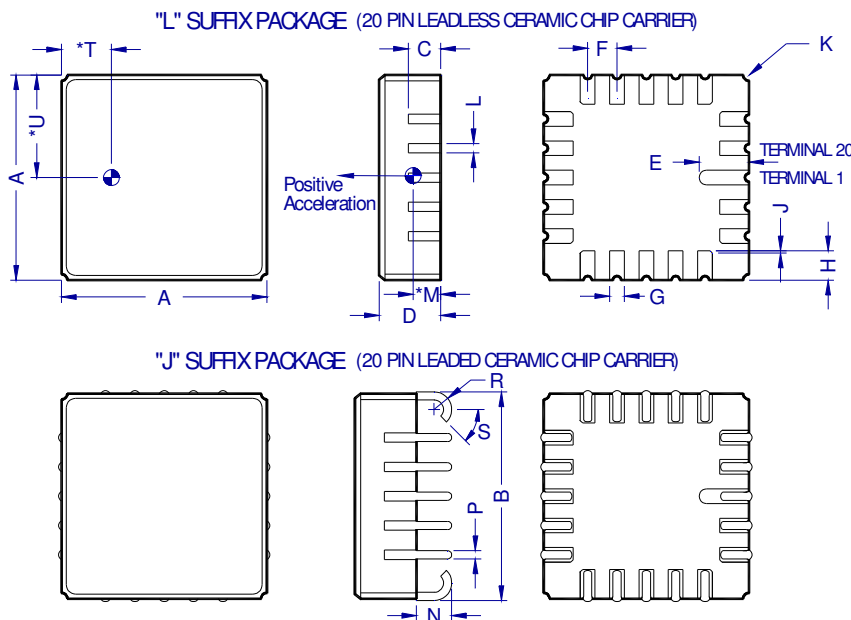

| Dim | Inches | | Millimeters | |
|-----|-------------|-------|-------------|------|
| | Min | Max | Min | Max |
| A | 0.342 | 0.358 | 8.69 | 9.09 |
| B | 0.346 | 0.378 | 8.79 | 9.60 |
| C | 0.055 TYP | | 1.40 TYP | |
| D | 0.095 | 0.115 | 2.41 | 2.92 |
| E | 0.085 TYP | | 2.16 TYP | |
| F | 0.050 BSC | | 1.27 BSC | |
| G | 0.025 TYP | | 0.64 TYP | |
| H | 0.050 TYP | | 1.27 TYP | |
| J | 0.004 x 45° | | 0.10 x 45° | |
| K | 0.010 R TYP | | 0.25 R TYP | |
| L | 0.016 TYP | | 0.41 TYP | |
| * M | 0.048 TYP | | 1.23 TYP | |
| N | 0.050 | 0.070 | 1.27 | 1.78 |
| P | 0.017 TYP | | 0.43 TYP | |
| R | 0.023 R TYP | | 0.58 R TYP | |
| * T | 0.085 TYP | | 2.16 TYP | |
| * U | 0.175 TYP | | 4.45 TYP | |

SPECIFICATIONS SUBJECT TO CHANGE WITHOUT NOTICE