

# Operation manual

## Oxygen sensor



Using oxygen sensors made by **SENSORE**, oxygen can be measured in gaseous media within a concentration range from 10 ppm O<sub>2</sub> up to 96 % O<sub>2</sub> depending on the sensor type. The sensor is thus characterized by the following essential characteristics:

- High accuracy
- For many types a more or less linear characteristic
- Small temperature dependence of the sensor signal
- Low interference with other gases
- Long service life
- In many cases “Single point calibration“ necessary only once

Technical data see in the appendix (specification).

### Definition of types

Example SO-B0-250-A100C

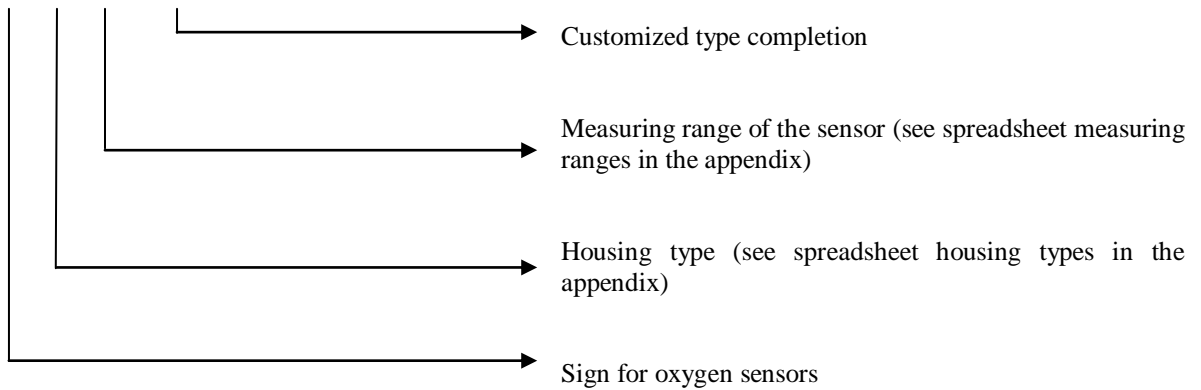

### Sensor's function

If a voltage is applied to the sensor then this sensor operates as a current source, whose output current is dependent on the oxygen concentration of the measuring gas. For this the current is at a certain oxygen concentration dependent on the measuring range selected and on the sensor's production tolerances. Due to these production tolerances each sensor must be calibrated individually! The required, type-dependent sensor voltages and output current ranges are listed in the Sensor type table in the appendix.

For all sensor types and for all calibration gas concentrations the following formula is valid:

$$I_s([O_2]) = -k \cdot \ln\left(1 - \frac{[O_2]}{100}\right)$$

- $I_s([O_2])$       Sensor current in the measuring medium  
 $[O_2]$             Oxygen concentration in the measuring medium in %  
 $k$                 Sensor-specific constant

To determine the sensor-specific constant the sensor must be put in a gaseous medium with a known oxygen concentration (calibration). With the sensor current measured in this gas and the following formula the  $k$  constant can be calculated

# Operation manual

## Oxygen sensor



$$k = \frac{-I_k([O_2])}{\ln\left(1 - \frac{[O_{2,k}]}{100}\right)}$$

$k$	Sensor-specific constant
$I_k[O_2]$	Sensor current at a given oxygen concentration
$[O_{2,k}]$	Given oxygen concentration (calibration gas concentration) in %

For sensor types SO-xx-250 and SO-xx-960 which can be calibrated in air, the sensor current follows as a function of the oxygen concentration the equation:

$$I_s([O_2]) = \frac{-I_s(20.9\%)}{0.2345} \cdot \ln\left(1 - \frac{[O_2]}{100}\right)$$

$I_s[O_2]$	Sensor current at a given concentration
$I_s(20.9\%)$	Sensor current measured in air [20.9 %]
$[O_2]$	Oxygen concentration in %

For small oxygen concentrations the formula can be simplified mathematically and a linear connection results:

$$I_1([O_2]) = k \cdot [O_2]$$

in which k can be determined under the same conditions as described above:

$$k = \frac{I_k([O_2])}{[O_{2,k}]}$$

$I([O_2])$	Sensor current in the measuring medium
$[O_2]$	Oxygen concentration in the measuring medium in %
$k$	Sensor-specific constant
$I_k[O_2]$	Sensor current at a given oxygen concentration
$[O_{2,k}]$	Given oxygen concentration (calibration gas concentration) in %

The sensor output current can be measured either by using a commercial ammeter or it can be converted into an easily measurable voltage with the help of an operational amplifier circuit. The appendix contains a circuit suggestion for this.

### Sensor heater operating modes

In order to operate the sensor it is necessary to heat it. This is carried out using the sensor heater integrated in the sensor. There are two different modes.

#### *Constant heater voltage*

If the ambient temperature fluctuations are small (a few degrees °C), then the heating can be operated by means of a constant voltage with current limitation. The necessary heater voltage depends on the sensor housing and is listed with recommended heater current limitation in the appendix. In this heater operation mode the output signal changes by 0.034 % / °C ambient temperature.

The appendix also contains a circuit suggestion for this.

# Operation manual

## Oxygen sensor

---



### *Constant heater resistance*

However, if higher variations in temperature (e.g. exhaust gas measurement) or also higher gas flow rates occur, then the sensor temperature must be kept constant to increase the measuring accuracy.

To keep the sensor temperature constant a rheostatic control is used, which always adjusts the sensor heater's resistance and thus the sensor temperature to the same value independent from the ambient temperature. This desired value of the rheostat is calculated as follows starting from the cold resistance of the sensor heater:

$$R_{w,soll} = f \cdot R_{(25^{\circ}C)}$$

$R_{w,soll}$	Resistance of the sensor heating in operation
$R_{(25^{\circ}C)}$	Resistance of the sensor heating at 25 °C
$f$	Temperature factor 2.8; in some applications also 2.65

**SENSORE** offers an electronic circuit (EDAB-M1V2-L) by which the sensor can be operated in the simplest way (see description in the appendix).

# Operation manual

## Oxygen sensor



### Pin connection for different sensor types

TO39 (Type SO-A0-xxx), TO8 (Type SO-Bx-xxx)

- 1 H+ (HS+)
- 2 H- (HS-)
- 3 Sen+
- 4 Sen-

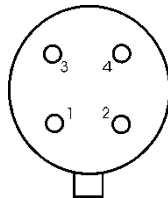

(Pin-side view)



### Sensors with connecting cable for 4-wire operation (SO-Bz-xxx-AxxxC, SO-Dz-xxx-AxxxC)

Sensors with connecting leads (teflon isolation with temperature stability up to 250 °C):

Cable colour	Pin Connection	Connected to pin No.
Violet 1	H+	1
Violet 2	HS+	
White 1	H-	2
White 2	HS	
Red	Sen+	3
Black	Sen-	4

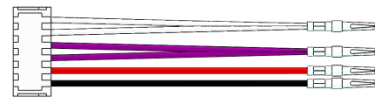

Schematic drawing of sensor connection cable with plug, view from backside of the plug

### Basic circuit of the sensor

There are additional leads named sense drawn in the basic circuit shown beside. With this leads the exact heater voltage at the sensor pins can be adjusted. This four wire measuring system is recommended for heater operation with constant voltage. In case of operation with constant resistance mode it is absolutely necessary to use this for wire measurement system.

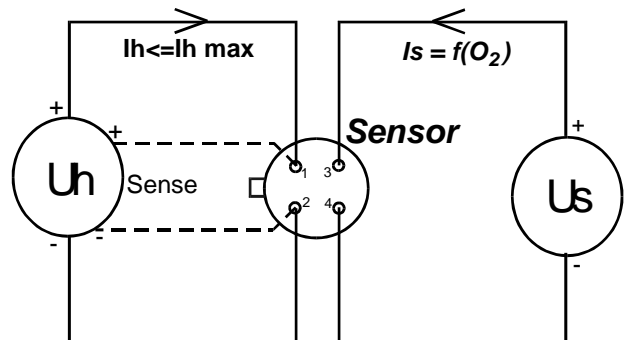

### Warning

Permanent damage to the sensor can occur due to the following circumstances:

- Sensor is in the unheated state in exhaust gas which contains H<sub>2</sub>S or SO<sub>x</sub>
- Contact with water or condensed humidity
- Contact with gases which contains halogens like F, Cl, Br
- Contact with organic vapors

The information contained in this document is believed to be accurate and reliable but is presented without guarantee.

# Operation manual

## Oxygen sensor



### Appendix: Operating parameters

#### Sensor heater / Constant heater voltage operation mode

Sensor type	Housing	Heater voltage (*)	Suggested current limitation
SO-A0-xxx	TO39	4.0 volt $\pm$ 0.05 volt	0.5 ampere
SO-B0-xxx (except 001)	TO8	3.6 volt $\pm$ 0.05 volt	0.5 ampere
SO-B0-001-xxxxx	TO8	3.8 volt $\pm$ 0.05 volt	0.5 ampere
SO-B1-xxx-xxxxx	TO8 with mounting flange	3.7 volt $\pm$ 0.05 volt	0.5 ampere
SO-D0-xxx-xxxxx	Screw mountable housing	4.1 volt $\pm$ 0.05 volt	0.5 ampere
SO-D1-xxx-xxxxx	Screw mountable housing	4.1 volt $\pm$ 0.05 volt	0.5 ampere
SO-D2-xxx-xxxxx	Aluminium Screw mountable housing	3.8 volt $\pm$ 0.05 volt	0.5 ampere
SO-E1-xxx	TO8 with hose connection	3.6 volt $\pm$ 0.05 volt	0.5 ampere
SO-E2-xxx-xxxxx	TO8	3.6 volt $\pm$ 0.05 volt	0.5 ampere

(\*) In case of deviate heater voltage the voltage is listed separately

#### Sensor heater / Constant heater resistance operation mode

Resistance of sensor heating at 25°C:  $R_{(25^{\circ}\text{C})} = 3.25 \Omega \pm 0.20 \Omega$

Sensor type	Housing	Heater resistance during operation	Suggested heating limitation
SO-xx-xxx	All types	R operation = R (25°C)*2.8	0,5 ampere or soft start (PWM)

#### Temperature dependence of the sensor signal

0.034 % measuring signal / °C ambient temperature in stagnant air(\*)

(\*) A temperature difference of 200 °C (e.g. exhausted gas measuring) means a raise of the sensor signal of 6.8%.

#### Pressure dependence of the sensor signal

in the range of 150 mbar – 800 mbar

2.0 % of measuring signal / 100 mbar

in the range of 800 mbar – 5.0 bar

0.5 % of measuring signal / 1 bar

#### Drift of sensor current

Neglectable

#### Max. potential difference between heater ground and sensor ground

$\pm$  3 Volt

#### Marking of the sensor

Example 412 3412 D

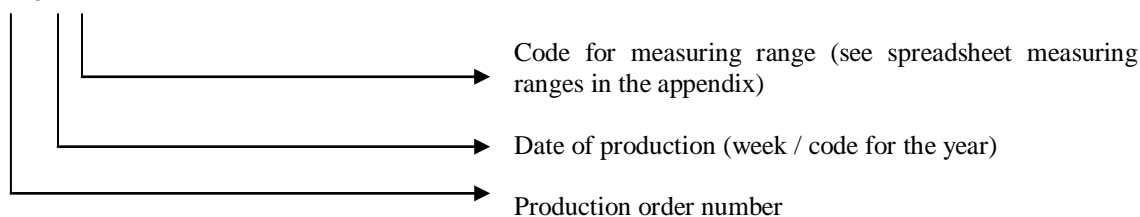

The information contained in this document is believed to be accurate and reliable but is presented without guarantee.

# Operation manual

## Oxygen sensor



### Packaging

SO-A0-xxx, SO-B0-xxx      Plastic case  
 All other types              Single or bounded to 10 pieces

### Mounting

SO-A0-xxx, SO-B0-xxx      suitable to solder into a PCB; distance to PCB at least 3 mm  
 All other types              Mountable in any housing

### Cross sensitivities

Gas	Max. concentration of the checked gas	Cross sensitivity [Δ% O <sub>2</sub> / % Gas]	at oxygen concentration
CO <sub>2</sub>	40 %	-0.027	20 % O <sub>2</sub>
CO <sub>2</sub>	40 %	-0.01	5 % O <sub>2</sub>
CO	1000 ppm	-0.73	20 % O <sub>2</sub>
CO	1000 ppm	-0.83	5 % O <sub>2</sub>
NO <sub>2</sub>	1000 ppm	1.06	
SO <sub>2</sub>	1000 ppm	-0.24	
CH <sub>4</sub>	1000 ppm	-1.77	5 % O <sub>2</sub>
H <sub>2</sub> S	400 ppm	≈ 0.0	
H <sub>2</sub> O (humidity) SO-xx-960 excluded	90% abs	≈ 0.0	

### Appendix: Change of oxygen content due to humidity

Dalton's law (law of partial pressures)

The total pressure  $p_{total}$  exerted by the mixture of non-reactive gases is equal to the sum of the partial pressures  $p_i$  of individual gases.

$$p_{total} = p_{bar}(h) = \sum_{i=1}^k p_i \quad p_i = \frac{[X_i]}{100} \cdot p_{bar}(h)$$

$[X_i]$  Mole fraction of gas i in %  
 $p_i$  Partial pressure of gas i  
 $p_{bar}(h)$  Height-dependent barometric pressure (sea level Vienna ~ 160 m  $\rightarrow$   $p_{bar} \sim 990$  mbar)

Dry air contains roughly (by volume) 78.084% nitrogen, 20.942% oxygen, 0.934% argon, and small amounts of other gases. Water vapour which is present by an average of 0.4 vol.% (range: 0 – 4 vol.%), is not included in the above composition, because this amount depends on several environmental conditions. When air is humid, the water vapour associated partial pressure displaces the surrounding air, resulting in a reduction of the relative oxygen content. This water vapour pressure is directly proportional to the temperature-dependent saturated vapour pressure.

$$[O_{2\ humid}] = [O_{2\ dry}] \cdot \frac{p_{bar} - p_d}{p_{bar}} \quad p_d = \frac{\varphi}{100} \cdot p_s(T)$$

$p_d$  Water vapour pressure [mbar]  
 $\varphi$  Relative humidity in %  
 $p_s(T)$  Temperature-dependent saturated vapour pressure [mbar]  
 $[O_{2\ humid}]$  Oxygen content of humid in Vol.%  
 $[O_{2\ dry}]$  Height independent oxygen content of dry air = 20.942 Vol.%

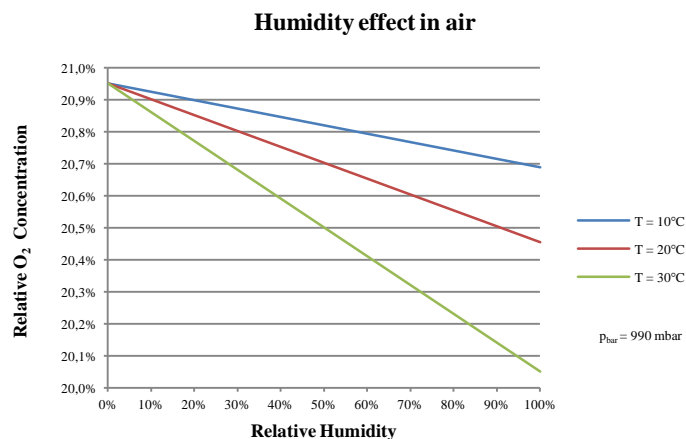

**Attention:**

The above-mentioned reduction of oxygen content due to moisture is measurable with all Sensore O<sub>2</sub> sensors except for the SO-xx-960 types. Because of a higher sensor voltage (1.6 V) they are able to split water vapour (H<sub>2</sub>O). This additional oxygen causes a positive cross-sensitivity, which leads to an increase of the sensor signal.

The information contained in this document is believed to be accurate and reliable but is presented without guarantee.

### Appendix: Sensor characteristics for different sensor types

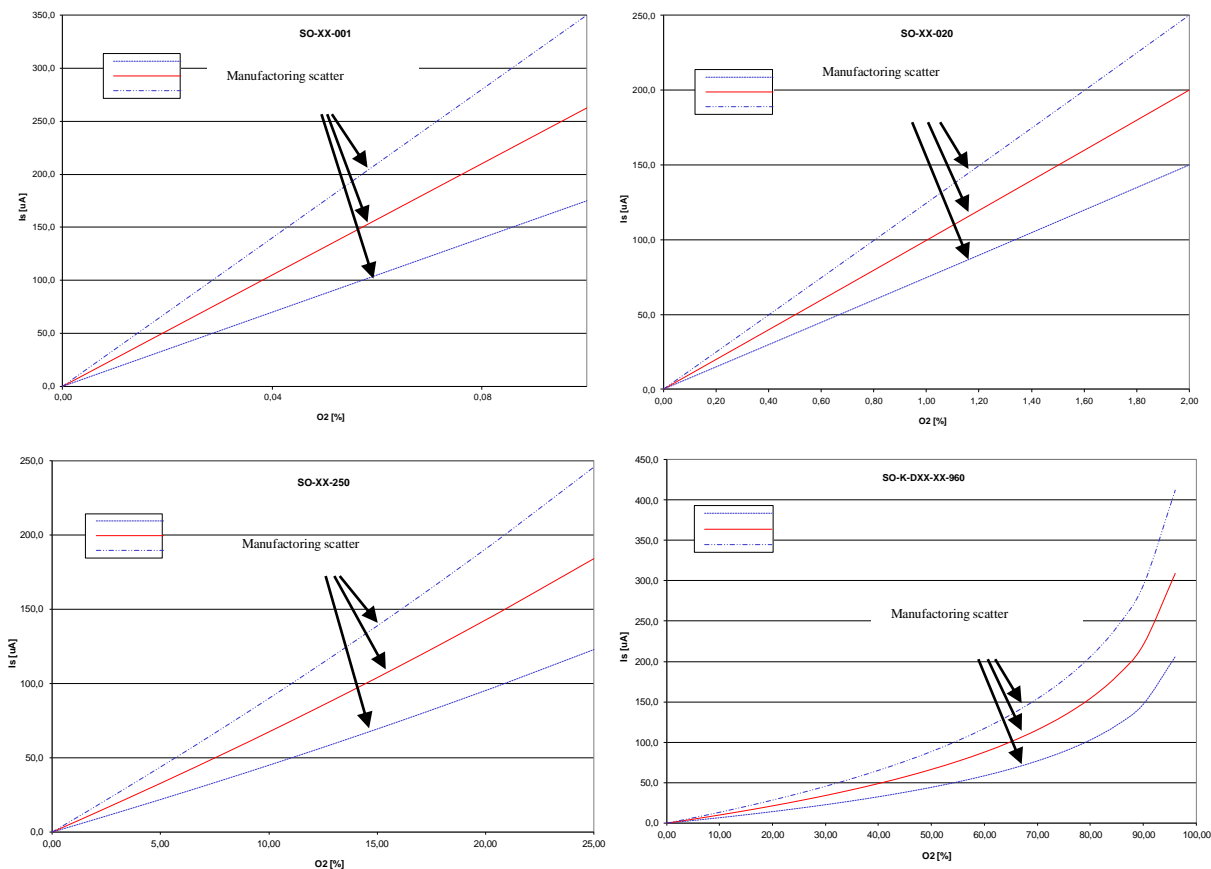

Different sensor characteristics

ATTENTION: In each case only one characteristic applies per sensor!

### Sensor electronics versions from SENSORE

SENSORE offers three electronic versions for easy control of the sensor:

- **CSB:** Electronic sensor board for oxygen sensors.
- **EDAB-M1:** Electronic board with temperature control and linearization of the characteristic sensor curve.
- **GSB:** Compact version of EDAB-N1: temperature control and linearization of the characteristic sensor curve.

The **CSB** (Compact sensor board) provides a plugged/soldered sensor with a fixed heater voltage, is compatible to all SENSORE  $O_2$  sensors of the type SO-xx-xxx and has a current or a voltage output.

**EDAB-M1** contains the temperature control specified in the description and in addition to the signal conversion mentioned also a linearization of the sensor characteristic so that a complicated conversion of the output signal to the measured oxygen concentration is not applicable. The GSB is compared to EDAB-M1 more compact, has a current output and can be reprogrammed according to customer requirements.

A more detailed description of the functions is contained in the respective data sheets.



# Operation manual

## Oxygen sensor



### Appendix: Simple circuit suggestion

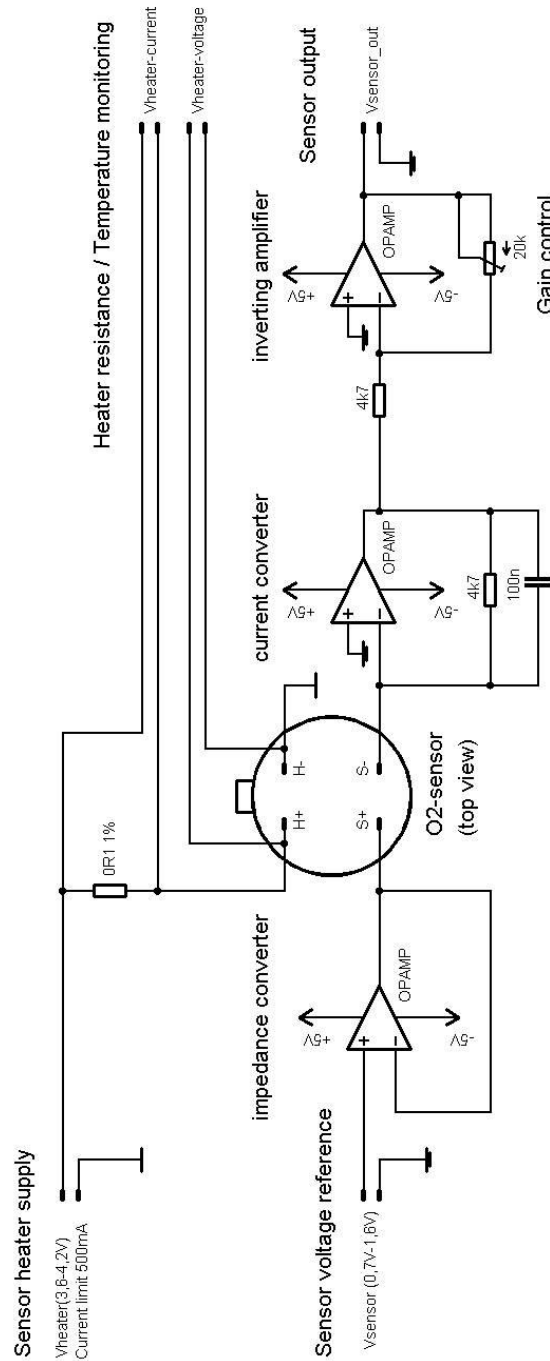

The information contained in this document is believed to be accurate and reliable but is presented without guarantee.