



## Low-Power CMOS Ionization Smoke Detector IC with Interconnect

The MC14468, when used with an ionization chamber and a small number of external components, will detect smoke. When smoke is sensed, an alarm is sounded via an external piezoelectric transducer and internal drivers. This circuit is designed to operate in smoke detector systems that comply with UL217 and UL268 specifications.

- Ionization Type with On-Chip FET Input Comparator
- Piezoelectric Horn Driver
- Guard Outputs on Both Sides of Detect Input
- Input-Production Diodes on the Detect Input
- Low-Battery Trip Point, Internally Set, can be Altered Via External Resistor
- Detect Threshold, Internally Set, can be Altered Via External Resistor
- Pulse Testing for Low Battery Uses LED for Battery Loading
- Comparator Output for Detect
- Internal Reverse Battery Protection
- Strobe Output for External Trim Resistors
- I/O Pin Allows Up to 40 Units to be Connected for Common Signaling
- Power-On Reset Prevents False Alarms on Battery Change

# MC14468

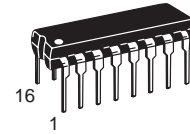

**P SUFFIX  
PLASTIC DIP  
CASE 648-08**

**ORDERING INFORMATION  
MC14468P PLASTIC DIP**

### PIN ASSIGNMENT (16 PIN DIP)

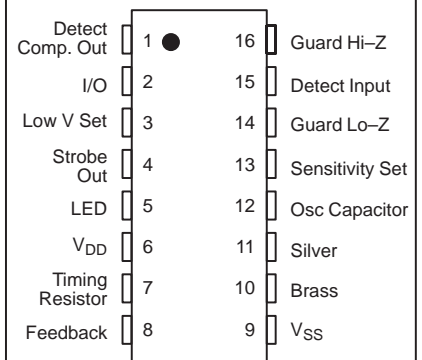

### MAXIMUM RATINGS\* (Voltages referenced to V<sub>SS</sub>)

Rating	Symbol	Value	Unit
DC Supply Voltage	V <sub>DD</sub>	-0.5 to +15	V
Input Voltage, All Inputs Except Pin 8	V <sub>in</sub>	-0.25 to V <sub>DD</sub> + 0.25	V
DC Current Drain per Input Pin, Except Pin 15 = 1 mA	I	10	mA
DC Current Drain per Output Pin	I	30	mA
Operating Temperature Range	T <sub>A</sub>	-10 to +60	°C
Storage Temperature Range	T <sub>stg</sub>	-55 to +125	°C
Reverse Battery Time	t <sub>RB</sub>	5.0	s

\* Maximum Ratings are those values beyond which damage to the device may occur.

This device contains circuitry to protect the inputs against damage due to high static voltages or electric fields; however, it is advised that normal precautions be taken to avoid application of any voltage higher than maximum rated voltages to this high impedance circuit. For proper operation it is recommended that V<sub>in</sub> and V<sub>out</sub> be constrained to the range V<sub>SS</sub> ≤ (V<sub>in</sub> or V<sub>out</sub>) ≤ V<sub>DD</sub>.



**RECOMMENDED OPERATING CONDITIONS** (Voltages referenced to  $V_{SS}$ )

Parameter	Symbol	Value	Unit
Supply Voltage	$V_{DD}$	9.0	V
Timing Capacitor	—	0.1	$\mu\text{F}$
Timing Resistor	—	8.2	$\text{M}\Omega$
Battery Load (Resistor or LED)	—	10	mA

**ELECTRICAL CHARACTERISTICS** ( $T_A = 25^\circ\text{C}$ )

Characteristic	Symbol	$V_{DD}$ $V_{dc}$	Min	Typ#	Max	Unit
Operating Voltage	$V_{DD}$	—	6.0	—	12	V
Output Voltage Piezoelectric Horn Drivers ( $I_{OH} = -16 \text{ mA}$ )	$V_{OH}$	7.2	6.3	—	—	V
Comparators ( $I_{OH} = -30 \mu\text{A}$ )		9.0	8.5	8.8	—	
Piezoelectric Horn Drivers ( $I_{OL} = +16 \text{ mA}$ )	$V_{OL}$	7.2	—	—	0.9	V
Comparators ( $I_{OL} = +30 \mu\text{A}$ )		9.0	—	0.1	0.5	
Output Voltage — LED Driver, $I_{OL} = 10 \text{ mA}$	$V_{OL}$	7.2	—	—	3.0	V
Output Impedance, Active Guard Pin 14	Lo-Z	9.0	—	—	10	$\text{k}\Omega$
Pin 16	Hi-Z	9.0	—	—	1000	
Operating Current ( $R_{bias} = 8.2 \text{ M}\Omega$ )	$I_{DD}$	9.0 12.0	— —	5.0 —	9.0 12.0	$\mu\text{A}$
Input Current — Detect (40% R.H.)	$I_{in}$	9.0	—	—	$\pm 1.0$	$\text{pA}$
Input Current, Pin 8	$I_{in}$	9.0	—	—	$\pm 0.1$	$\mu\text{A}$
Input Current @ $50^\circ\text{C}$ , Pin 15	$I_{in}$	—	—	—	$\pm 6.0$	$\text{pA}$
Internal Set Voltage Low Battery	$V_{low}$	9.0	7.2	—	7.8	V
Sensitivity	$V_{set}$	—	47	50	53	$\%V_{DD}$
Hysteresis	$v_{hys}$	9.0	75	100	150	mV
Offset Voltage (measured at $V_{in} = V_{DD}/2$ ) Active Guard	$V_{OS}$	9.0	—	—	$\pm 100$	mV
Detect Comparator		9.0	—	—	$\pm 50$	
Input Voltage Range, Pin 8	$V_{in}$	—	$V_{SS} - 10$	—	$V_{DD} + 10$	V
Input Capacitance	$C_{in}$	—	—	5.0	—	$\text{pF}$
Common Mode Voltage Range, Pin 15	$V_{cm}$	—	0.6	—	$V_{DD} - 2$	V
I/O Current, Pin 2 Input, $V_{IH} = V_{DD} - 2$	$I_{IH}$	—	25	—	100	$\mu\text{A}$
Output, $V_{OH} = V_{DD} - 2$	$I_{OH}$	—	-4.0	—	-16	mA

# Data labelled "Typ" is not to be used for design purposes but is intended as an indication of the IC's potential performance.

**TIMING PARAMETERS** (C = 0.1  $\mu$ F, R<sub>bias</sub> = 8.2 M $\Omega$ , V<sub>DD</sub> = 9.0 V, T<sub>A</sub> = 25°C, See Figure 6)

Characteristics		Symbol	Min	Typ#	Max	Units
Oscillator Period	No Smoke	t <sub>Cl</sub>	1.34	1.67	2.0	s
	Smoke		32	40	48	ms
Oscillator Rise Time		t <sub>r</sub>	8.0	10	12	ms
Horn Output (During Smoke)	On Time	PW <sub>on</sub>	120	160	208	ms
	Off Time	PW <sub>off</sub>	60	80	104	ms
LED Output	Between Pulses	t <sub>LED</sub>	32	40	48	s
	On Time	PW <sub>on</sub>	8.0	10	12	ms
Horn Output (During Low Battery)	On Time	t <sub>on</sub>	8.0	10	12	ms
	Between Pulses	t <sub>off</sub>	32	40	48	s

# Data labelled "Typ" is not to be used for design purposes but is intended as an indication of the IC's potential performance.

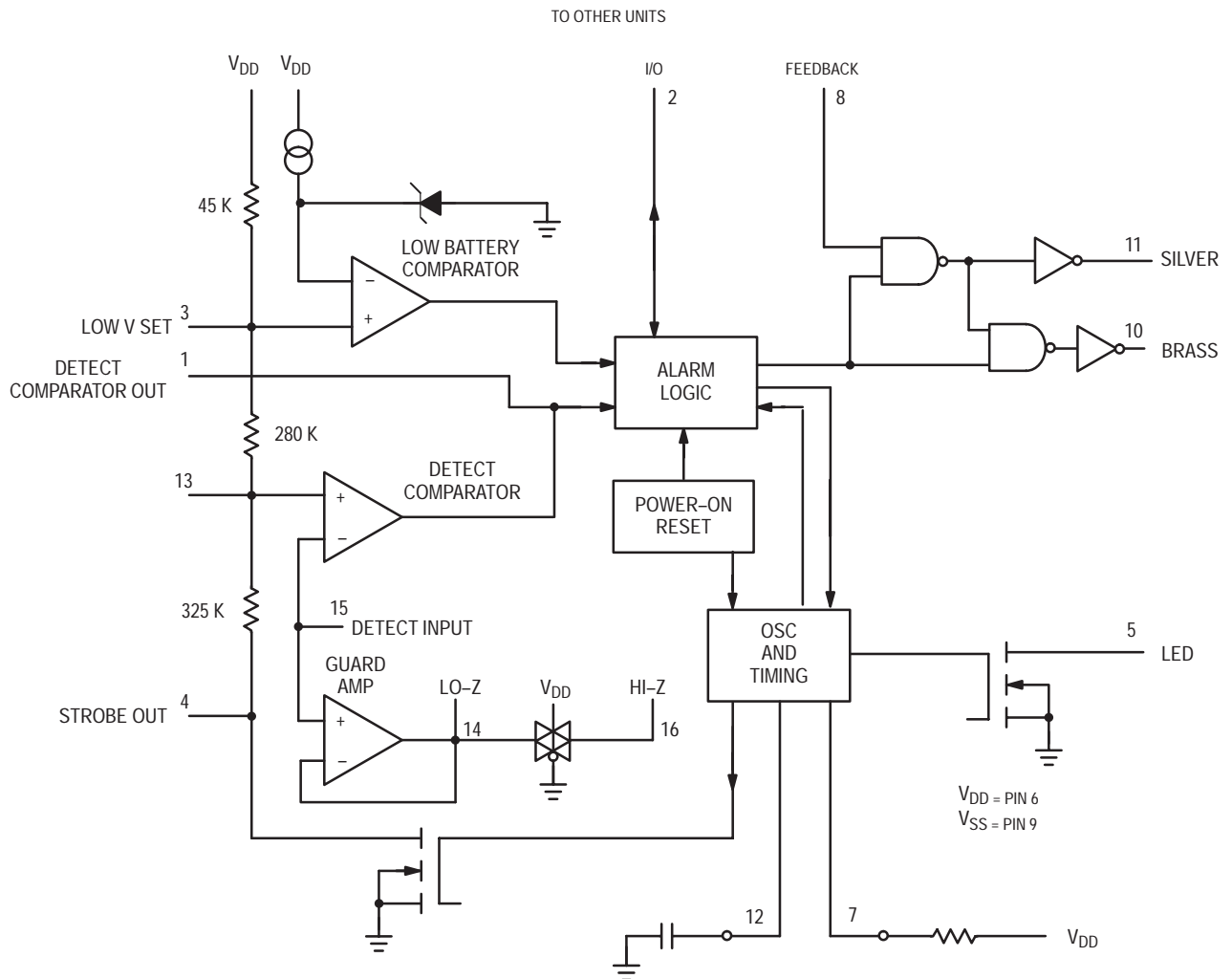
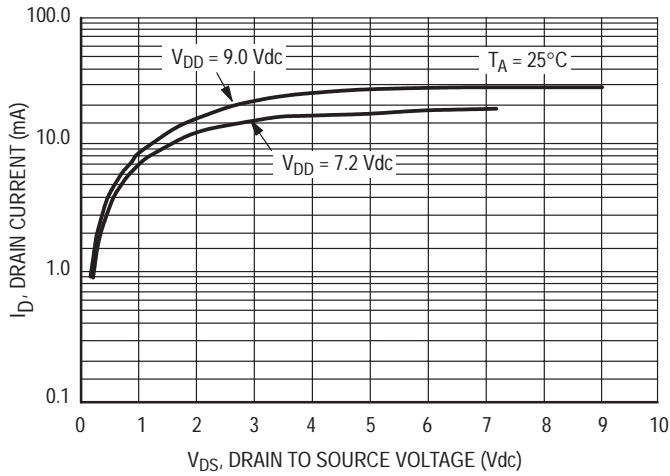
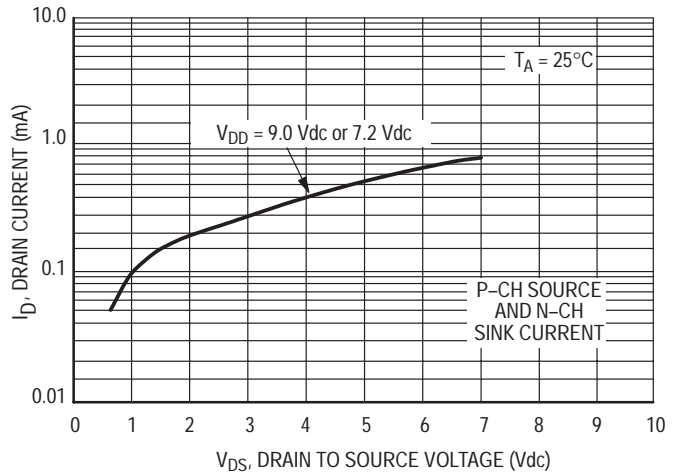

Figure 1. Block Diagram



**Figure 2. Typical LED Output I-V Characteristic**



**Figure 3. Typical Comparator Output I-V Characteristic**

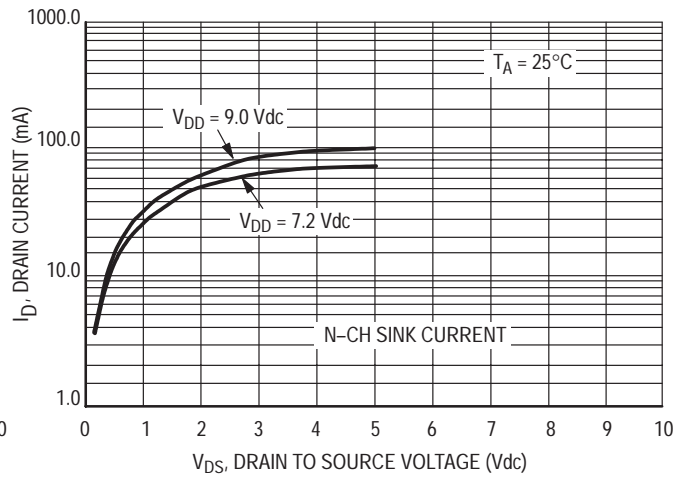
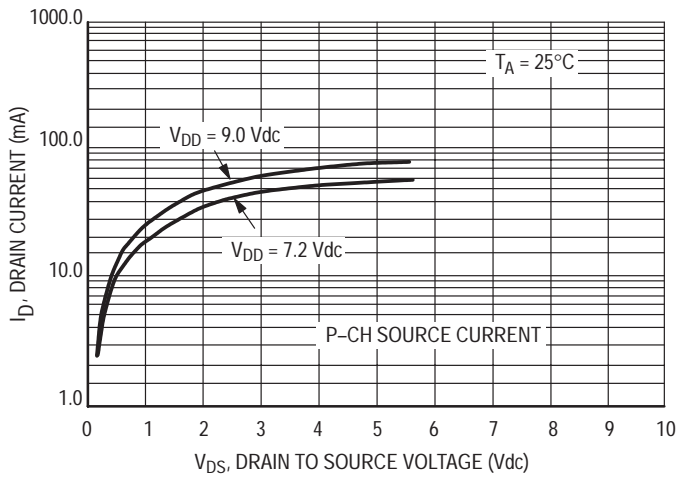

**Figure 4. Typical P Horn Driver Output I-V Characteristic**

**DEVICE OPERATION**

**TIMING**

The internal oscillator of the MC14468 operates with a period of 1.67 seconds during no-smoke conditions. Each 1.67 seconds, internal power is applied to the entire IC and a check is made for smoke, except during LED pulse, Low Battery Alarm Chirp, or Horn Modulation (in smoke). Every 24 clock cycles a check is made for low battery by comparing  $V_{DD}$  to an internal zener voltage. Since very small currents are used in the oscillator, the oscillator capacitor should be of a low leakage type.

**DETECT CIRCUITRY**

If smoke is detected, the oscillator period becomes 40 ms and the piezoelectric horn oscillator circuit is enabled. The horn output is modulated 160 ms on, 80 ms off. During the off time, smoke is again checked and will inhibit further horn output if no smoke is sensed. During local smoke conditions the low battery alarm is inhibited, but the LED pulses at a 1.0 Hz rate. In remote smoke, the LED is inhibited as well.

An active guard is provided on both pins adjacent to the detect input. The voltage at these pins will be within 100 mV of the input signal. This will keep surface leakage currents to a minimum and provide a method of measuring the input voltage without loading the ionization chamber. The active guard op amp is not power strobed and thus gives constant protection from surface leakage currents. Pin 15 (the Detect input) has internal diode protection against static damage.

**INTERCONNECT**

The I/O (Pin 2), in combination with  $V_{SS}$ , is used to interconnect up to 40 remote units for common signaling. A Local Smoke condition activates a current limited output driver, thereby signaling Remote Smoke to interconnected units. A small current sink improves noise immunity during non-smoke conditions. Remote units at lower voltages do not

draw excessive current from a sending unit at a higher voltage. The I/O is disabled for three oscillator cycles after power up, to eliminate false alarming of remote units when the battery is changed.

**SENSITIVITY/LOW BATTERY THRESHOLDS**

Both the sensitivity threshold and the low battery voltage levels are set internally by a common voltage divider (please see Figure 1) connected between  $V_{DD}$  and  $V_{SS}$ . These voltages can be altered by external resistors connected from pins 3 or 13 to either  $V_{DD}$  or  $V_{SS}$ . There will be a slight interaction here due to the common voltage divider network. The sensitivity threshold can also be set by adjusting the smoke chamber ionization source.

**TEST MODE**

Since the internal op amps and comparators are power strobed, adjustments for sensitivity or low battery level could be difficult and/or time-consuming. By forcing Pin 12 to  $V_{SS}$ , the power strobing is bypassed and the output, Pin 1, constantly shows smoke/no smoke. Pin 1 =  $V_{DD}$  for smoke. In this mode and during the 10 ms power strobe, chip current rises to approximately 50  $\mu$ A.

**LED PULSE**

The 9-volt battery level is checked every 40 seconds during the LED pulse. The battery is loaded via a 10 mA pulse for 10 ms. If the LED is not used, it should be replaced with an equivalent resistor such that the battery loading remains at 10 mA.

**HYSTERESIS**

When smoke is detected, the resistor/divider network that sets sensitivity is altered to increase sensitivity. This yields approximately 100 mV of hysteresis and reduces false triggering.

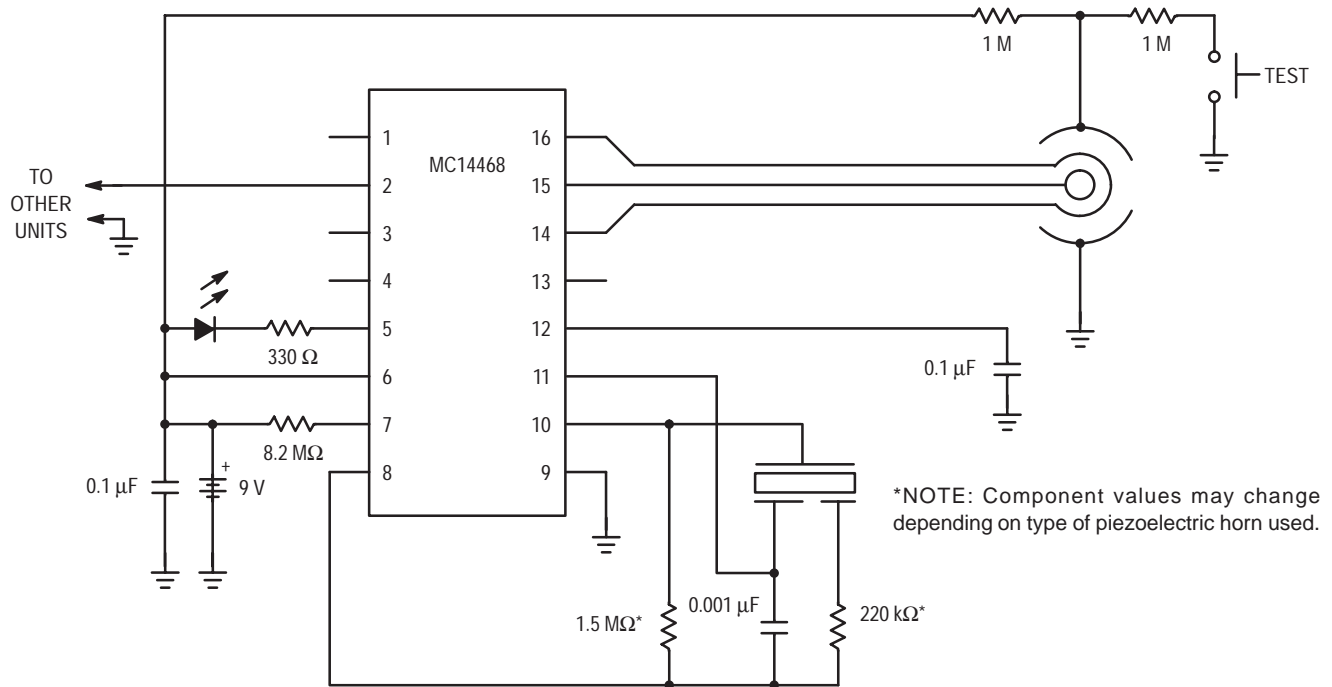

**Figure 5. Typical Application as Ionization Smoke Detector**

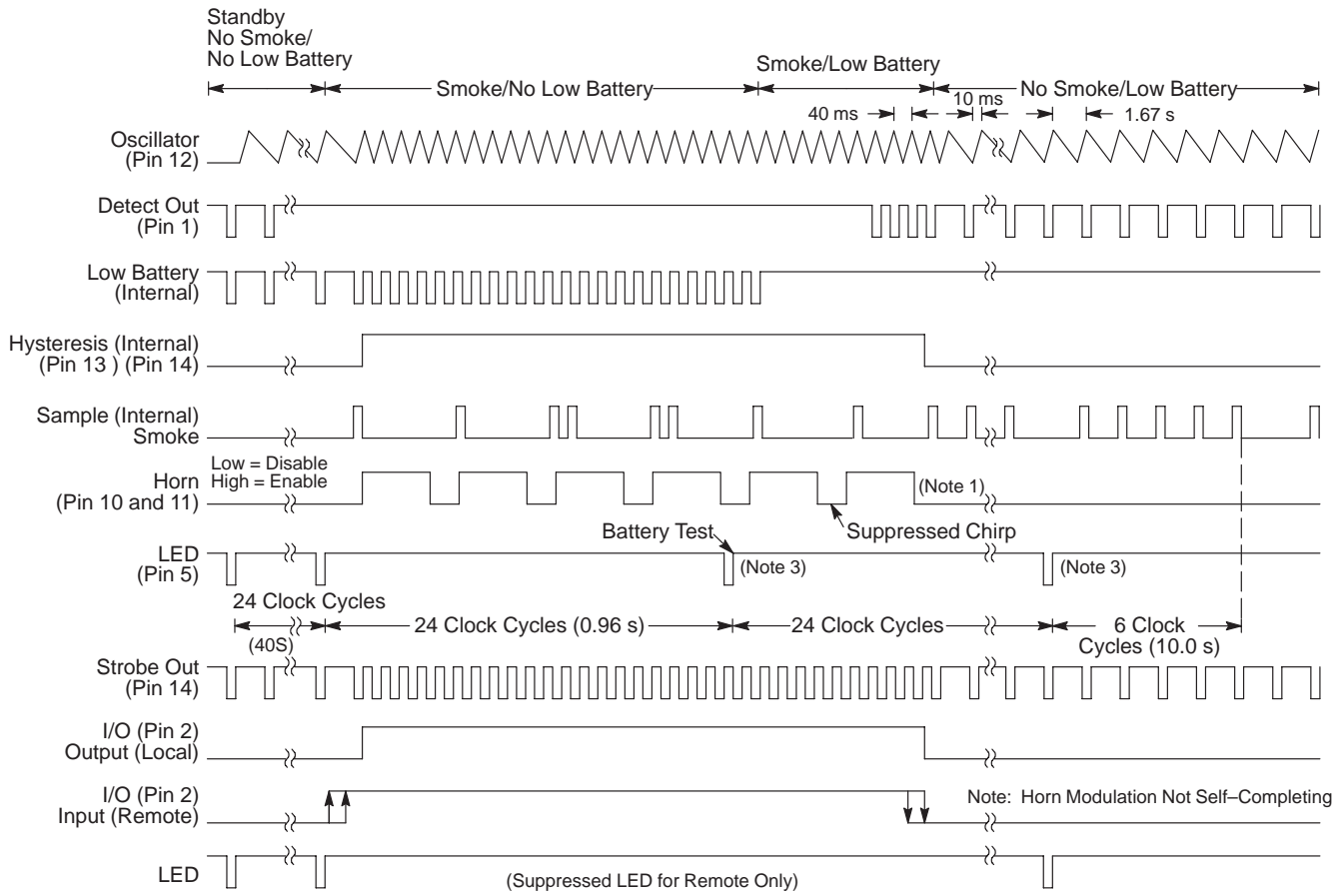
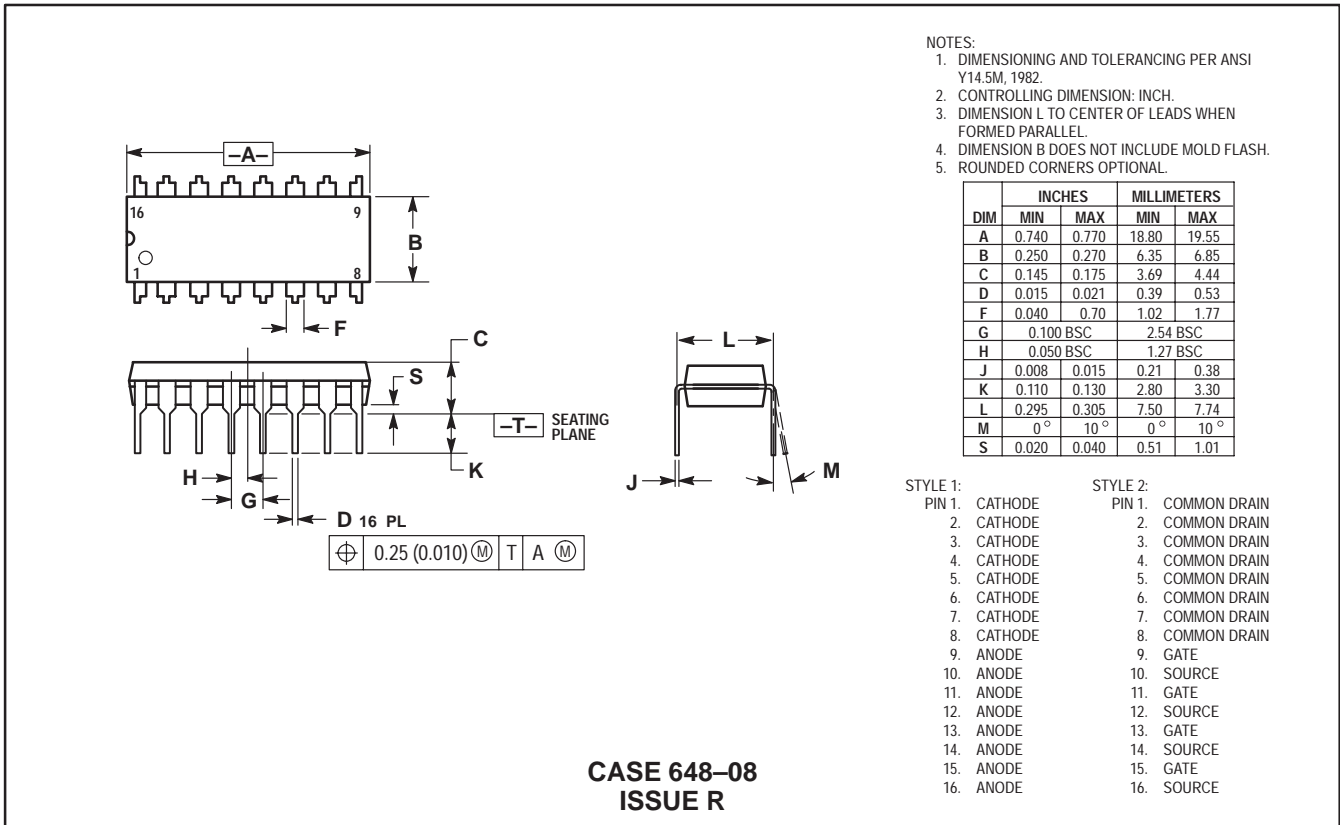

Figure 6. Timing Diagram

NOTES:

1. Horn modulation is self-completing. When going from smoke to no smoke, the alarm condition will terminate only when horn is off.
2. Comparators are strobed on once per clock cycle (1.67 s for no smoke, 40 ms for smoke).
3. Low battery comparator information is latched only during LED pulse.
4. ~ 100 mV p-p swing.

**PACKAGE DIMENSIONS**



Mfax is a trademark of Motorola, Inc.

Motorola reserves the right to make changes without further notice to any products herein. Motorola makes no warranty, representation or guarantee regarding the suitability of its products for any particular purpose, nor does Motorola assume any liability arising out of the application or use of any product or circuit, and specifically disclaims any and all liability, including without limitation consequential or incidental damages. "Typical" parameters which may be provided in Motorola data sheets and/or specifications can and do vary in different applications and actual performance may vary over time. All operating parameters, including "Typicals" must be validated for each customer application by customer's technical experts. Motorola does not convey any license under its patent rights nor the rights of others. Motorola products are not designed, intended, or authorized for use as components in systems intended for surgical implant into the body, or other applications intended to support or sustain life, or for any other application in which the failure of the Motorola product could create a situation where personal injury or death may occur. Should Buyer purchase or use Motorola products for any such unintended or unauthorized application, Buyer shall indemnify and hold Motorola and its officers, employees, subsidiaries, affiliates, and distributors harmless against all claims, costs, damages, and expenses, and reasonable attorney fees arising out of, directly or indirectly, any claim of personal injury or death associated with such unintended or unauthorized use, even if such claim alleges that Motorola was negligent regarding the design or manufacture of the part. Motorola and  are registered trademarks of Motorola, Inc. Motorola, Inc. is an Equal Opportunity/Affirmative Action Employer.

#### How to reach us:

**USA/EUROPE/Locations Not Listed:** Motorola Literature Distribution; P.O. Box 5405, Denver, Colorado 80217.  
1-303-675-2140 or 1-800-441-2447

**JAPAN:** Motorola Japan Ltd.; SPS, Technical Information Center, 3-20-1, Minami-Azabu, Minato-ku, Tokyo 106-8573 Japan.  
81-3-3440-3569

**ASIA/PACIFIC:** Motorola Semiconductors H.K. Ltd.; Silicon Harbour Centre, 2 Dai King Street, Tai Po Industrial Estate, Tai Po, N.T., Hong Kong. 852-26668334

#### Customer Focus Center: 1-800-521-6274

**Mfax™:** RMFAX0@email.sps.mot.com – TOUCHTONE 1-602-244-6609  
Motorola Fax Back System – US & Canada ONLY 1-800-774-1848  
– <http://sps.motorola.com/mfax/>

**HOME PAGE:** <http://motorola.com/sps/>





欢迎索取免费详细资料、设计选型指南和光盘、样品；产品繁多未能尽录，欢迎来电查询。

[中国传感器科技信息网：HTTP://WWW.SENSOR-IC.COM/](http://WWW.SENSOR-IC.COM/)

[工控安防网：HTTP://WWW.PC-PS.NET/](http://WWW.PC-PS.NET/)

[消费电子专用电路网：HTTP://WWW.SUNSTARE.COM/](http://WWW.SUNSTARE.COM/)

E-MAIL：[xjr5@163.com](mailto:xjr5@163.com) [szss20@163.com](mailto:szss20@163.com)

MSN：[suns8888@hotmail.com](mailto:suns8888@hotmail.com)

QQ：195847376

地址：深圳市福田区福华路福庆街鸿图大厦 1602 室

电话：0755-83376549 83376489 83387030 83387016

传真：0755-83376182 83338339 邮编：518033 手机：(0)13902971329

深圳展销部：深圳华强北路赛格电子市场 2583 号 TEL/FAX：  
0755-83665529 25059422

北京分公司：北京海淀区知春路 132 号中发电子大厦 3097 号

TEL：010-81159046 82615020 13501189838 FAX：010-82613476

上海分公司：上海市北京东路 668 号上海赛格电子市场 2B35 号

TEL：021-28311762 56703037 13701955389 FAX：021-56703037

西安分公司：西安高新开发区 20 所(中国电子科技集团导航技术研究所)  
西安劳动南路 88 号电子商城二楼 D23 号

TEL：029-81022619 13072977981 FAX:029-88789382

成都：TEL:(0)13717066236

技术支持：0755-83394033 13501568376

SUNSTAR商斯达实业集团是集研发、生产、工程、销售、代理经销、技术咨询、信息服务等为一体的高科技企业，是专业高科技电子产品生产厂家，是具有10多年历史的专业电子元器件供应商，是中国最早和最大的仓储式连锁规模经营大型综合电子零部件代理分销商之一，是一家专业代理和分销世界各大品牌IC芯片和电子元器件的连锁经营综合性国际公司。在香港、北京、深圳、上海、西安、成都等全国主要电子市场设有直属分公司和产品展示展销窗口门市部专卖店及代理分销商，已在全国范围内建成强大统一的供货和代理分销网络。我们专业代理经销、开发生产电子元器件、集成电路、传感器、微波光电元器件、工控机/DOC/DOM电子盘、专用电路、单片机开发、MCU/DSP/ARM/FPGA软件硬件、二极管、三极管、模块等，是您可靠的一站式现货配套供应商、方案提供商、部件功能模块开发配套商。专业以现代信息产业（计算机、通讯及传感器）三大支柱之一的传感器为主营业务，专业经营各类传感器的代理、销售生产、网络信息、科技图书资料及配套产品设计、工程开发。我们的专业网站——中国传感器科技信息网（全球传感器数据库）[www.SENSOR-IC.COM](http://www.SENSOR-IC.COM) 服务于全球高科技生产商及贸易商，为企业科技产品开发提供技术交流平台。欢迎各厂商互通有无、交换信息、交换链接、发布寻求代理信息。欢迎国外高科技传感器、变送器、执行器、自动控制产品厂商介绍产品到中国，共同开拓市场。本网站是关于各种传感器-变送器-仪器仪表及工业自动化大型专业网站，深入到工业控制、系统工程计 测量、自动化、安防报警、消费电子等众多领域，把最新的传感器-变送器-仪器仪表买卖信息，最新技术供求，最新采购商，行业动态，发展方向，最新的技术应用和市场资讯及时的传递给广大科技开发、科学研究、产品设计人员。本网站已成功为石油、化工、电力、医药、生物、航空、航天、国防、能源、冶金、电子、工业、农业、交通、汽车、矿山、煤炭、纺织、信息、通信、IT、安防、环保、印刷、科研、气象、仪器仪表等领域从事科学研究、产品设计、开发、生产制造的科技人员、管理人员、和采购人员提供满意服务。我公司专业生产、代理、经销、销售各种传感器、变送器、敏感元器件、开关、执行器、仪器仪表、自动化控制系统：专业从事设计、生产、销售各种传感器、变送器、各种测控仪表、热工仪表、现场控制器、计算机控制系统、数据采集系统、各类环境监控系统、专用控制系统应用软件以及嵌入式系统开发及应用等工作。如热敏电阻、压敏电阻、温度传感器、温度变送器、湿度传感器、湿度变送器、气体传感器、气体变送器、压力传感器、压力变送、称重传感器、物（液）位传感器、物（液）位变送器、流量传感器、流量变送器、电流（压）传感器、溶氧传感器、霍尔传感器、图像传感器、超声波传感器、位移传感器、速度传感器、加速度传感器、扭距传感器、红外传感器、紫外传感器、火焰传感器、激光传感器、振动传感器、轴角传感器、光电传感器、接近传感器、干簧管传感器、继电器传感器、微型电泵、磁敏（阻）传感器、压力开关、接近开关、光电开关、色标传感器、光纤传感器、齿轮测速传感器、时间继电器、计数器、计米器、温控仪、固态继电器、调压模块、电磁铁、电压表、电流表等特殊传感器。同时承接传感器应用电路、产品设计和自动化工程项目。

更多产品请看本公司产品专用销售网站：

商斯达中国传感器科技信息网：<http://www.sensor-ic.com/>

商斯达工控安防网：<http://www.pc-ps.net/>

商斯达电子元器件网：<http://www.sunstare.com/>

商斯达微波光电产品网：[HTTP://www.rfoe.net/](http://www.rfoe.net/)

商斯达消费电子产品网：<http://www.icasic.com/>

商斯达军工产品网：<http://www.junpinic.com/>

商斯达实业科技产品网：<http://www.sunstars.cn/>传感器销售热线：

地址：深圳市福田区福华路福庆街鸿图大厦1602室

电话：0755-83607652 83376489 83376549 83370250 83370251 82500323

传真：0755-83376182 (0) 13902971329 MSN: [SUNS888@hotmail.com](mailto:SUNS888@hotmail.com)

邮编：518033 E-mail: [szss20@163.com](mailto:szss20@163.com) QQ: 195847376

深圳赛格展销部：深圳华强北路赛格电子市场2583号 电话：0755-83665529 25059422

技术支持：0755-83394033 13501568376

欢迎索取免费详细资料、设计指南和光盘；产品凡多，未能尽录，欢迎来电查询。

北京分公司：北京海淀区知春路132号中发电子大厦3097号

TEL: 010-81159046 82615020 13501189838 FAX: 010-62543996

上海分公司：上海市北京东路668号上海赛格电子市场D125号

TEL: 021-28311762 56703037 13701955389 FAX: 021-56703037

西安分公司：西安高新开发区20所(中国电子科技集团导航技术研究所)

西安劳动南路88号电子商城二楼D23号

TEL: 029-81022619 13072977981 FAX:029-88789382