



## SMT GaAs PHEMT DUAL CHANNEL LOW NOISE AMPLIFIER, 550 - 1200 MHz

8

LOW NOISE AMPLIFIERS - SMT

### Typical Applications

The HMC817LP4E is ideal for:

- Cellular/3G and LTE/WiMAX/4G
- BTS & Infrastructure
- Repeaters and Femtocells
- Multi-Channel Applications
- Access Points

### Features

- Noise Figure: 0.5 dB
- Gain: 16 dB
- Output IP3: +37 dBm
- Single Supply: +3V to +5V
- 50 Ohm Matched Input/Output
- 24 Lead 4x4mm QFN Package: 16 mm<sup>2</sup>

### Functional Diagram

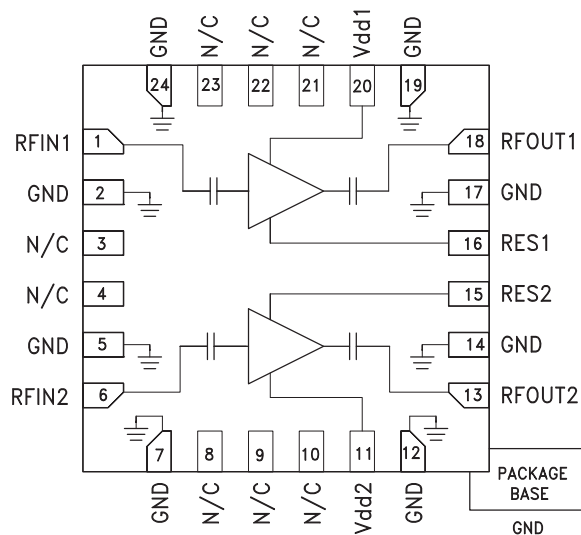

### General Description

The HMC817LP4E is a GaAs PHEMT Dual Channel Low Noise Amplifier that is ideal for Cellular/3G and LTE/WiMAX/4G basestation front-end receivers operating between 550 and 1200 MHz. The amplifier has been optimized to provide 0.5 dB noise figure, 24 dB gain and +37 dBm output IP3 from a single supply of +5V. Input and output return losses are excellent with minimal external matching and bias decoupling components. The HMC817LP4E shares the same package and pinout with the HMC816LP4E and HMC818LP4E LNAs. The HMC817LP4E can be biased with +3V to +5V and features an externally adjustable supply current which allows the designer to tailor the linearity performance of each channel of the LNA for each application.

### Electrical Specifications, $T_A = +25^\circ C$ , $R_{bias} 1, 2 = 10k\ Ohms^* V_{dd} = V_{dd1} = V_{dd2} = +5V, I_{dd} = I_{dd1} = I_{dd2}$

Parameter	Vdd = +3 V						Vdd = +5 V						Units
	Min.	Typ.	Max.	Min.	Typ.	Max.	Min.	Typ.	Max.	Min.	Typ.	Max.	
Frequency Range	698 - 960			550 - 1200			698 - 960			550 - 1200			MHz
Gain	13	16		11	15		13.5	16		11.5	16		dB
Gain Variation Over Temperature		0.003			0.003			0.005			0.005		dB/°C
Noise Figure		0.5	0.8		0.5	1.1		0.55	0.85		0.6	1.1	dB
Input Return Loss		28			22			22			17		dB
Output Return Loss		12			14			12			15		dB
Output Power for 1 dB Compression (P1dB)	14	16		12.5	16.5		18.5	20.5		16.5	21		dBm
Saturated Output Power (P <sub>sat</sub> )		17			17.5			21			21.5		dBm
Output Third Order Intercept (IP3)		31			30			37			37		dBm
Supply Current (I <sub>dd</sub> )	24	34	44	24	34	44	65	95	124	65	95	124	mA

\* R<sub>bias</sub> resistor sets current, see application circuit herein



**SMT GaAs PHEMT DUAL CHANNEL  
 LOW NOISE AMPLIFIER, 550 - 1200 MHz**

**Broadband Gain & Return Loss**

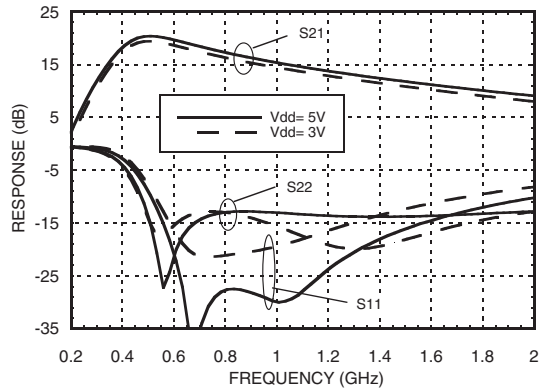

**Gain vs. Temperature [1]**

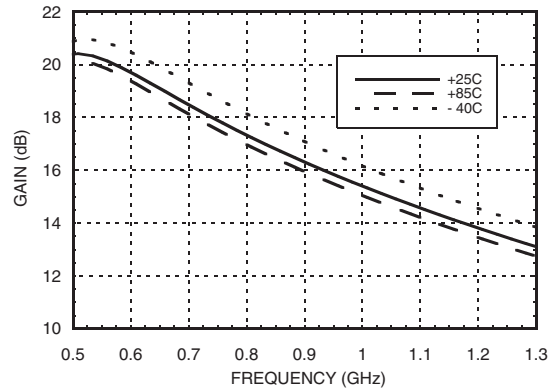

**Gain vs. Temperature [2]**

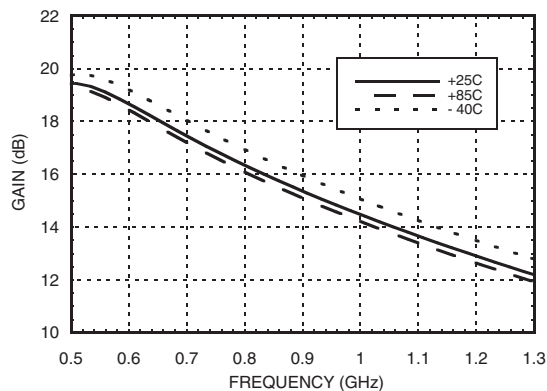

**Input Return Loss vs. Temperature [1]**

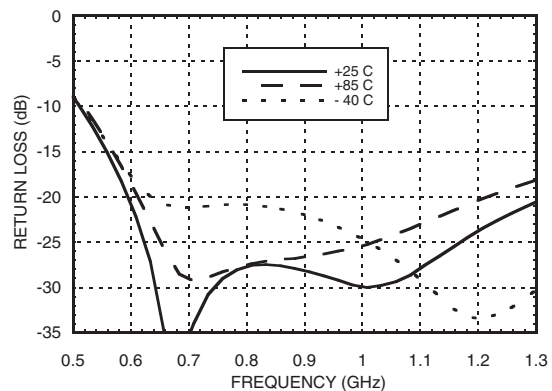

**Output Return Loss vs. Temperature [1]**

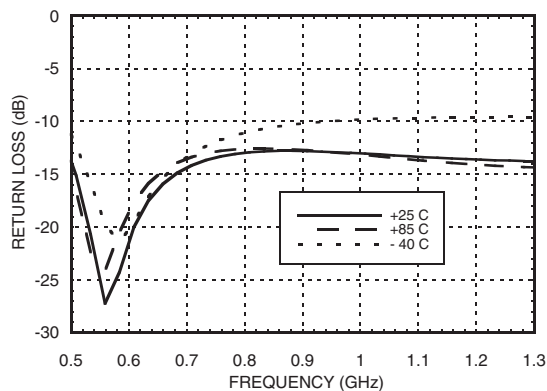

**Reverse Isolation vs. Temperature [1]**

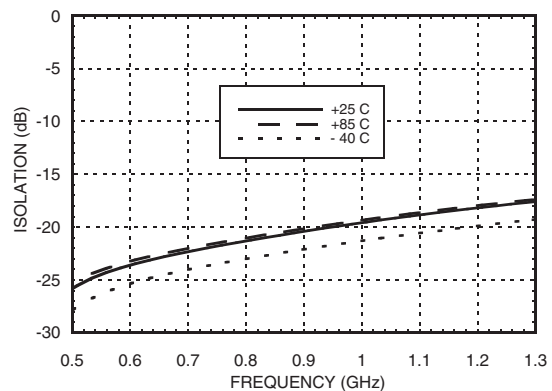

[1] Vdd = 5V [2] Vdd = 3V

### SMT GaAs PHEMT DUAL CHANNEL LOW NOISE AMPLIFIER, 550 - 1200 MHz



8 LOW NOISE AMPLIFIERS - SMT

**Noise Figure vs. Temperature [1]**

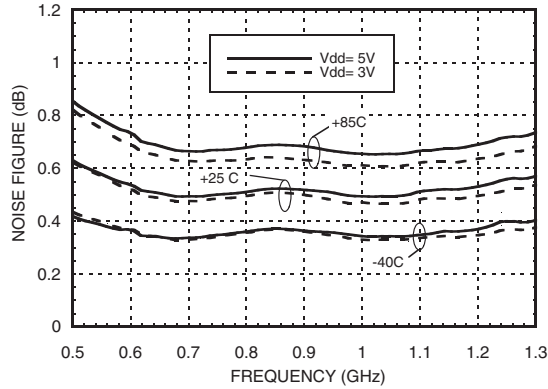

**P1dB vs. Temperature**

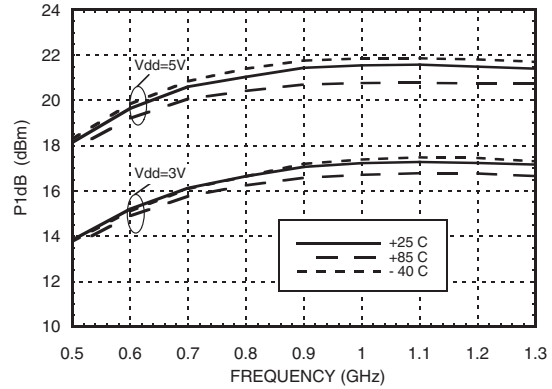

**Psat vs. Temperature**

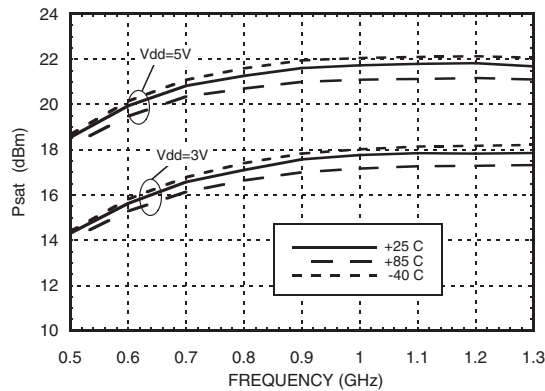

**Output IP3 vs. Temperature**

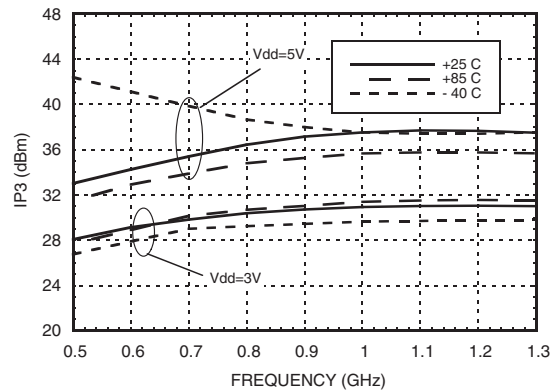

**Output IP3 and Supply Current vs. Supply Voltage @ 700 MHz**

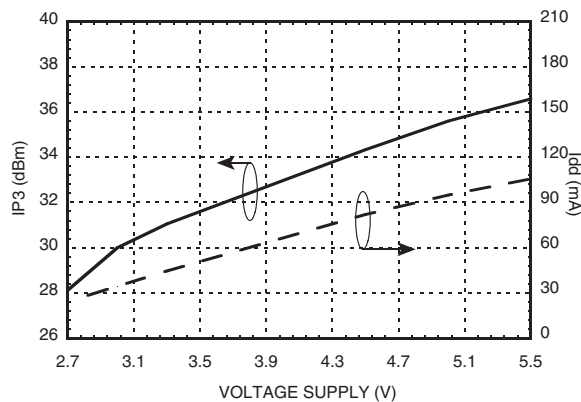

**Output IP3 and Supply Current vs. Supply Voltage @ 900 MHz**

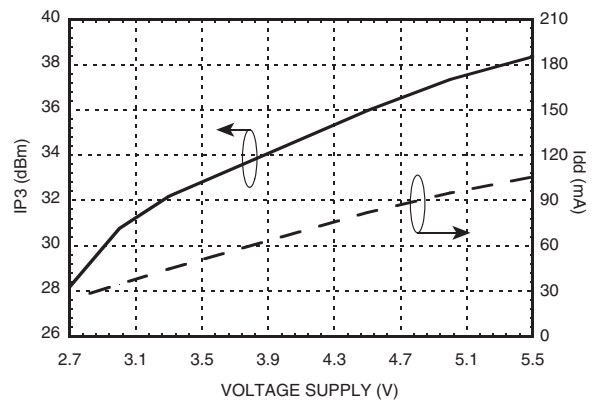

[1] Measurement reference plane shown on evaluation PCB drawing.



**SMT GaAs PHEMT DUAL CHANNEL  
 LOW NOISE AMPLIFIER, 550 - 1200 MHz**

**Power Compression @ 700 MHz [1]**

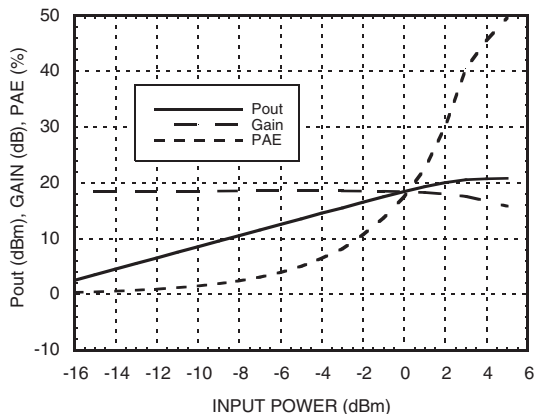

**Power Compression @ 900 MHz [1]**

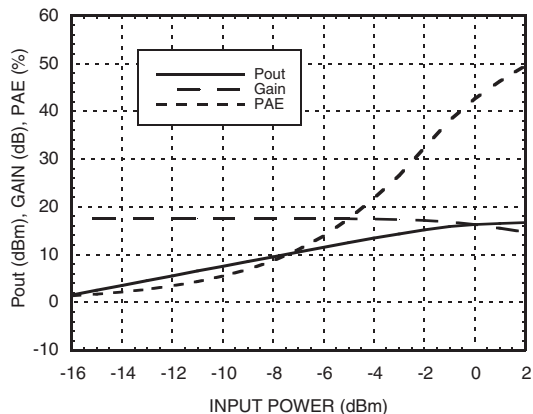

**Power Compression @ 700 MHz [2]**

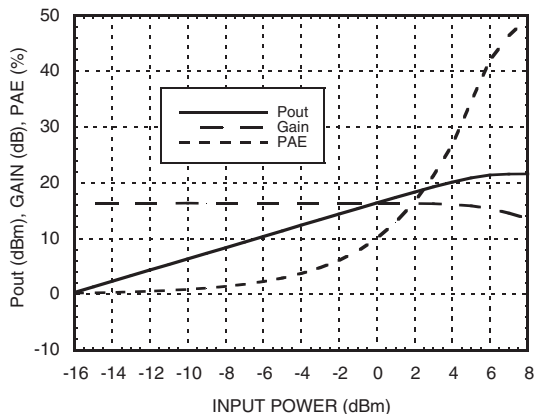

**Power Compression @ 900 MHz [2]**

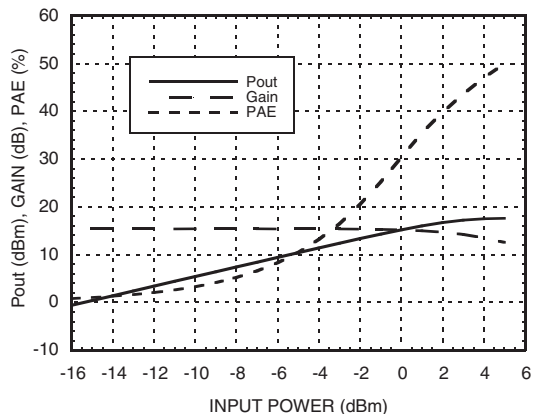

**Gain, Power & Noise Figure vs. Supply Voltage @ 700 MHz**

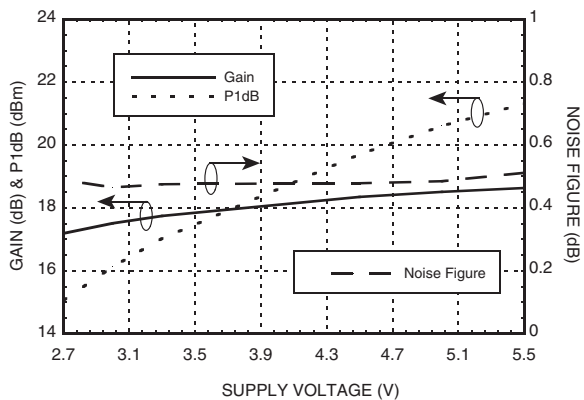

**Gain, Power & Noise Figure vs. Supply Voltage @ 900 MHz**

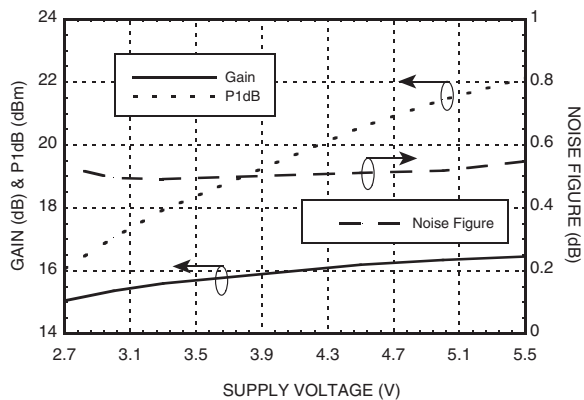

[1] Vdd = 5V [2] Vdd = 3V



**SMT GaAs PHEMT DUAL CHANNEL  
LOW NOISE AMPLIFIER, 550 - 1200 MHz**

8

LOW NOISE AMPLIFIERS - SMT

**Cross Channel Isolation [1]**

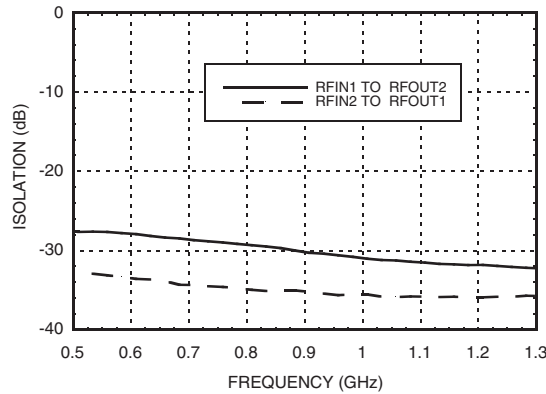

**Magnitude Balance [1]**

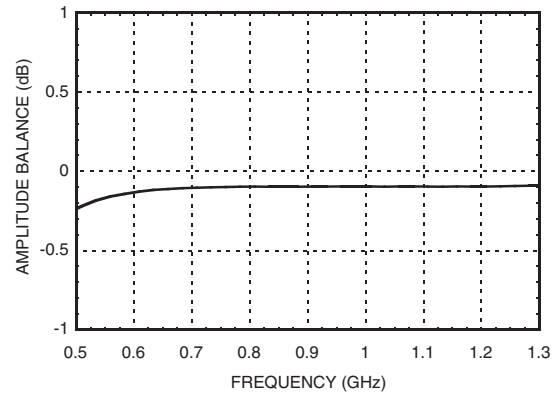

**Phase Balance [1]**

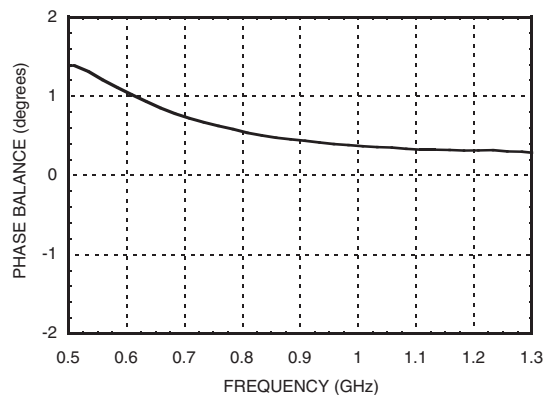

**Absolute Maximum Ratings**

Drain Bias Voltage (Vdd)	+6V
RF Input Power (RFIN) (Vdd = +5 Vdc)	+10 dBm
Channel Temperature	150 °C
Continuous Pdiss (T= 85 °C) (derate 16.67 mW/°C above 85 °C)	1.08 W
Thermal Resistance (channel to ground paddle)	60 °C/W
Storage Temperature	-65 to +150 °C
Operating Temperature	-40 to +85 °C

**Typical Supply  
Current vs. Vdd (Rbias = 10kΩ)**

Vdd (V)	Idd (mA)
2.7	24
3.0	34
3.3	44
4.5	82
5.0	95
5.5	105

Note: Amplifier will operate over full voltage ranges shown above.

**Absolute Bias Register for Idd  
Range & Recommended Bias Resistor**

Vdd (V)	Rbias Ω			Idd (mA)
	Min	Max	Recommended	
3V	10k	Open circuit	10k	34
5V	0	Open circuit	820	58
			2k	78
			10k	95

With Vdd = 3V Rbias <10k is not recommended and may result in LNA becoming conditionally unstable.

[1] Vdd = 5V [2] Vdd = 3V



**ELECTROSTATIC SENSITIVE DEVICE  
OBSERVE HANDLING PRECAUTIONS**



**SMT GaAs PHEMT DUAL CHANNEL  
LOW NOISE AMPLIFIER, 550 - 1200 MHz**

**Outline Drawing**

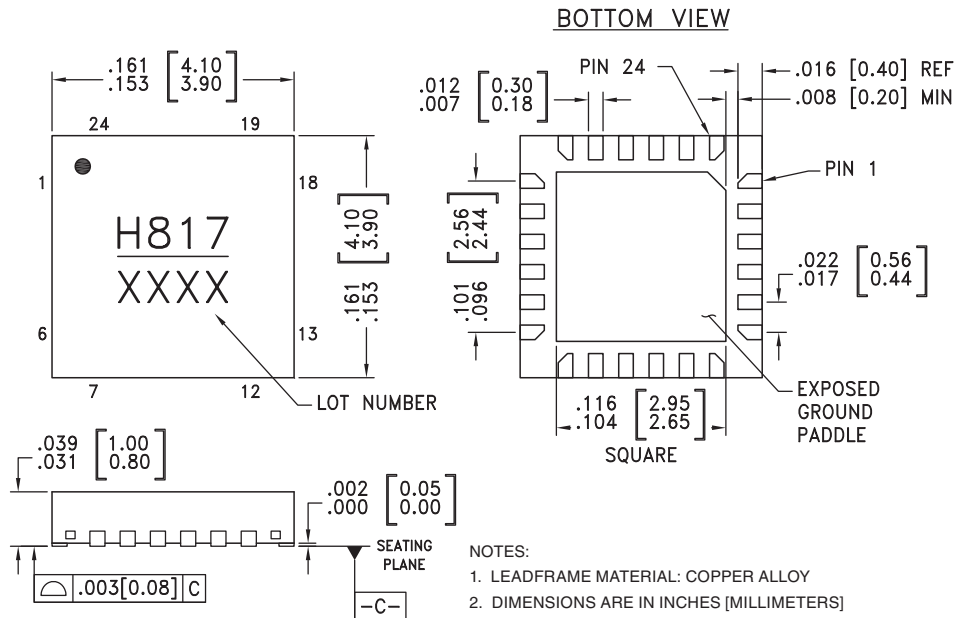

**NOTES:**

1. LEADFRAME MATERIAL: COPPER ALLOY
2. DIMENSIONS ARE IN INCHES (MILLIMETERS)
3. LEAD SPACING TOLERANCE IS NON-CUMULATIVE
4. PAD BURR LENGTH SHALL BE 0.15mm MAXIMUM.  
PAD BURR HEIGHT SHALL BE 0.05mm MAXIMUM.
5. PACKAGE WARP SHALL NOT EXCEED 0.05mm.
6. ALL GROUND LEADS AND GROUND PADDLE MUST BE SOLDERED TO PCB RF GROUND.
7. REFER TO HITTITE APPLICATION NOTE FOR SUGGESTED LAND PATTERN.

**Package Information**

Part Number	Package Body Material	Lead Finish	MSL Rating	Package Marking <sup>[1]</sup>
HMC817LP4E	RoHS-compliant Low Stress Injection Molded Plastic	100% matte Sn	MSL1 <sup>[2]</sup>	H817 XXXX

[1] 4-Digit lot number XXXX

[2] Max peak reflow temperature of 260 °C

**Pin Descriptions**

Pin Number	Function	Description	Interface Schematic
1, 6	RFIN1, RFIN2	These pins are matched to 50 Ohms.	
2, 5, 7, 12, 14, 17, 19, 24	GND	These pins and package bottom must be connected to RF/DC Ground.	
3, 4, 8 - 10, 21 - 23	N/C	No connection required. These pins may be connected to RF/DC ground without affecting performance.	



### SMT GaAs PHEMT DUAL CHANNEL LOW NOISE AMPLIFIER, 550 - 1200 MHz

#### Pin Descriptions (Continued)

Pin Number	Function	Description	Interface Schematic
11, 20	Vdd1, Vdd2	Power supply voltages for each amplifier. Choke inductor and bypass capacitors are required. See application circuit.	
13, 18	RFOUT1, RFOUT2	These pins are matched to 50 Ohms.	
15, 16	RES1, RES2	These pins are used to set the DC current of each amplifier via external biasing resistor. See application circuit.	

#### Application Circuit

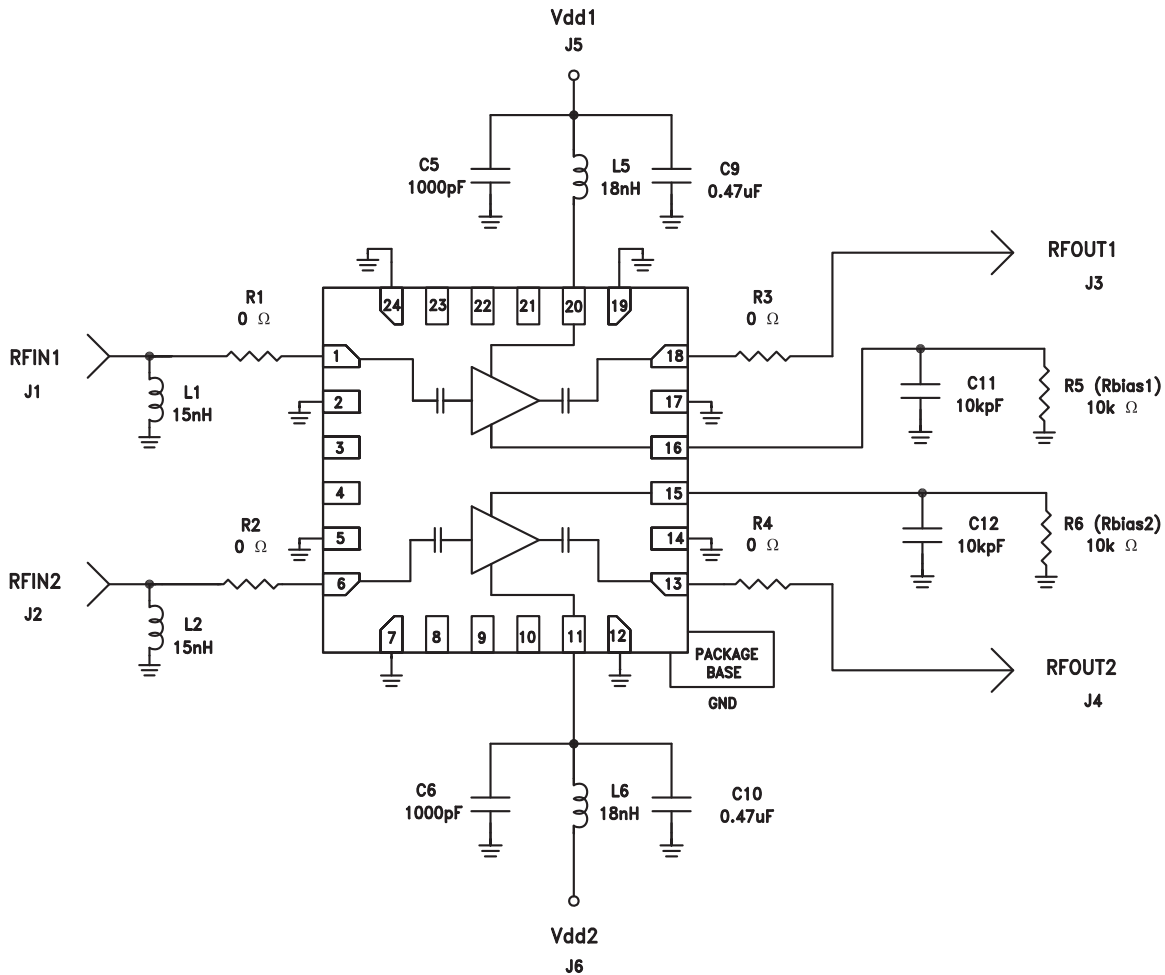



## SMT GaAs PHEMT DUAL CHANNEL LOW NOISE AMPLIFIER, 550 - 1200 MHz

### Evaluation PCB

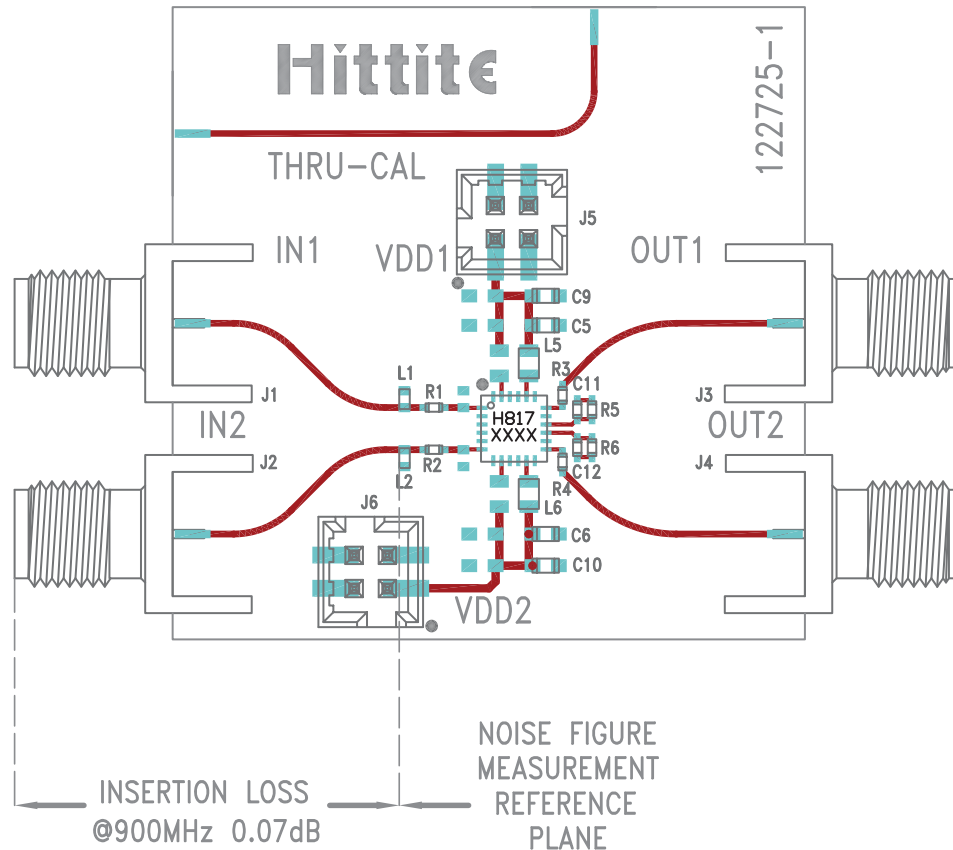

### List of Material for Evaluation PCB 123193 [1]

Item	Description
J1 - J4	PCB Mount SMA RF Connector
J5, J6	2mm Vertical Molex 8 pos Connector
C5, C6	1000 pF Capacitor, 0603 Pkg.
C9, C10	0.47 μF Capacitor, 0603 Pkg..
C11, C12	10 kF Capacitor, 0402 Pkg.
R1 - R4	0 Ohm Resistor, 0402 Pkg.
R5, R6 (Rbias 1, 2)	10K Resistor, 0402 Pkg.
L1, L2	15 nH Inductor, 0402 Pkg.
L5, L6	18 nH Inductor, 0603 Pkg.
U1	HMC817LP4E Amplifier
PCB [2]	122725 Evaluation PCB

[1] Reference this number when ordering complete evaluation PCB

[2] Circuit Board Material: Rogers 4350 or Arlon 25FR

The circuit board used in this application should use RF circuit design techniques. Signal lines should have 50 ohm impedance while the package ground leads and exposed paddle should be connected directly to the ground plane similar to that shown. A sufficient number of via holes should be used to connect the top and bottom ground planes. The evaluation board should be mounted to an appropriate heat sink. The evaluation circuit board shown is available from Hittite upon request.