

InGaP HBT GAIN BLOCK MMIC AMPLIFIER, DC - 5 GHz



Typical Applications

The HMC480ST89 / HMC480ST89E is an ideal RF/IF gain block & LO or PA driver for:

- Cellular / PCS / 3G
- Fixed Wireless & WLAN
- CATV, Cable Modem & DBS
- Microwave Radio & Test Equipment

Features

- P1dB Output Power: +19 dBm to 2.5 GHz
- Gain: 19 dB @ 1 GHz
16 dB @ 2 GHz
- +34 dBm Output IP3
- Single Supply: +6V to +8V
- Industry Standard SOT89 Package
- Included in the HMC-DK001 Designer's Kits

Functional Diagram

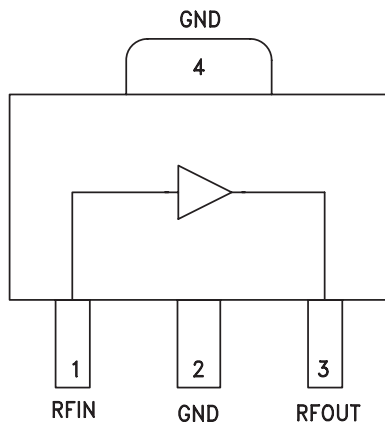

General Description

The HMC480ST89 & HMC480ST89E are InGaP HBT Gain Block MMIC SMT amplifiers covering DC to 5 GHz and packaged in an industry standard SOT89. The amplifier can be used as a cascadable 50 Ohm RF/IF gain stage as well as a LO or PA driver with up to +20 dBm P1dB output power for cellular/3G, FWA, CATV, microwave radio and test equipment applications. The HMC480ST89(E) offers 19 dB of gain with a +34 dBm output IP3 at 1 GHz while requiring only 82 mA from a single positive supply. The HMC480ST89(E) InGaP gain blocks offer excellent output IP3 and flat +19 to +20dBm output power performance through 5 GHz compared to equivalent SiGe based products.

Electrical Specifications, $V_s = 8.0 V$, $R_{bias} = 39 \text{ Ohm}$, $T_A = +25^\circ C$

Parameter	Min.	Typ.	Max.	Units	
Gain	DC - 1.0 GHz	17	19	dB	
	1.0 - 2.0 GHz	14	17	dB	
	2.0 - 3.0 GHz	12	15	dB	
	3.0 - 4.0 GHz	10	13	dB	
	4.0 - 5.0 GHz	8	11	dB	
Gain Variation Over Temperature	DC - 5 GHz		0.008	0.016	dB/ °C
Input Return Loss	DC - 1.0 GHz		17	dB	
	1.0 - 5.0 GHz		10	dB	
Output Return Loss	DC - 1.0 GHz		17	dB	
	1.0 - 5.0 GHz		10	dB	
Reverse Isolation	DC - 5 GHz		20	dB	
Output Power for 1 dB Compression (P1dB)	0.5 - 1.0 GHz	16	20	dBm	
	1.0 - 2.0 GHz	15.5	18.5	dBm	
	2.0 - 3.5 GHz	14.5	17.5	dBm	
	3.5 - 5.0 GHz	13	16	dBm	
Output Third Order Intercept (IP3) (Pout= 0 dBm per tone, 1 MHz spacing)	0.5 - 1.0 GHz		34	dBm	
	1.0 - 2.0 GHz		33	dBm	
	2.0 - 3.5 GHz		32	dBm	
	3.5 - 5.0 GHz		30	dBm	
Noise Figure	DC - 4 GHz		3.25	dB	
	4.0 - 5.0 GHz		4.0	dB	
Supply Current (Icq)			82	mA	

Note: Data taken with broadband bias tee on device output.



HMC480ST89 / 480ST89E

InGaP HBT GAIN BLOCK MMIC AMPLIFIER, DC - 5 GHz

Broadband Gain & Return Loss

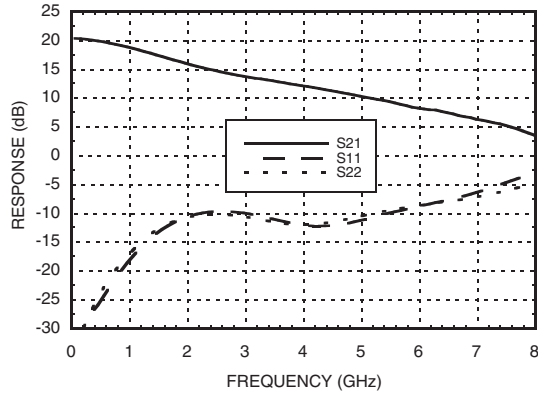

Gain vs. Temperature

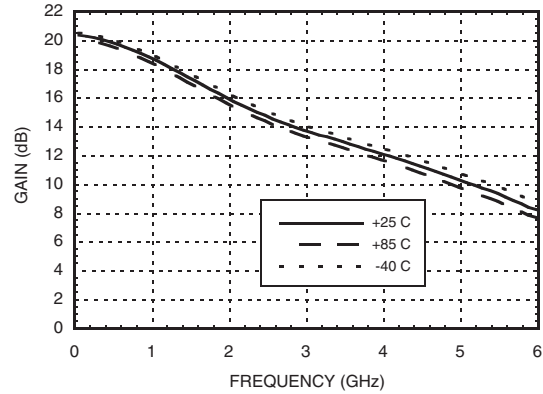

Input Return Loss vs. Temperature

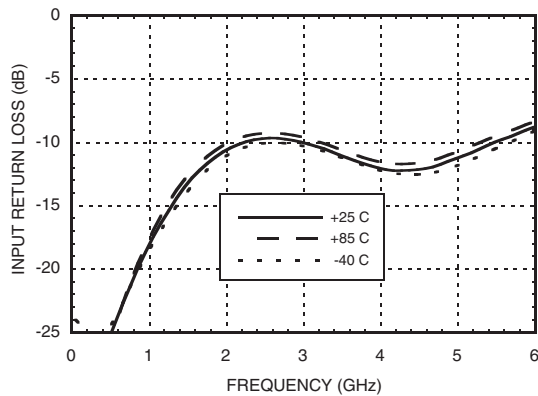

Output Return Loss vs. Temperature

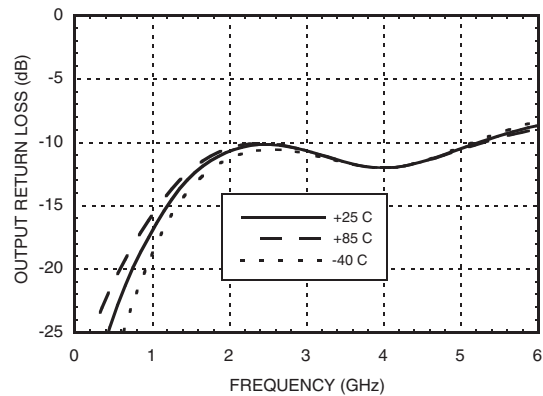

Reverse Isolation vs. Temperature

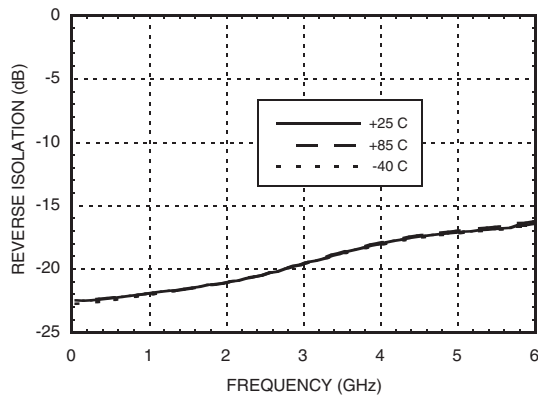

Noise Figure vs. Temperature

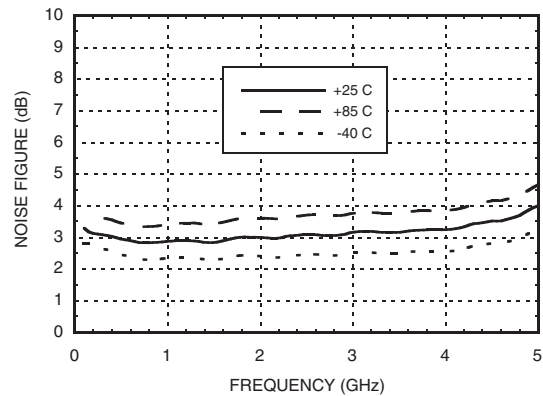



HMC480ST89 / 480ST89E

InGaP HBT GAIN BLOCK MMIC AMPLIFIER, DC - 5 GHz

5

DRIVER & GAIN BLOCK AMPLIFIERS - SMT

P1dB vs. Temperature

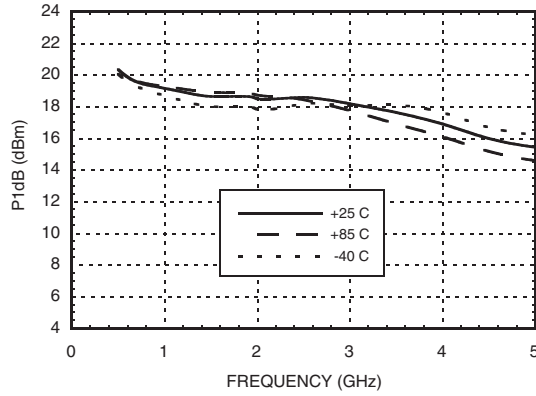

Psat vs. Temperature

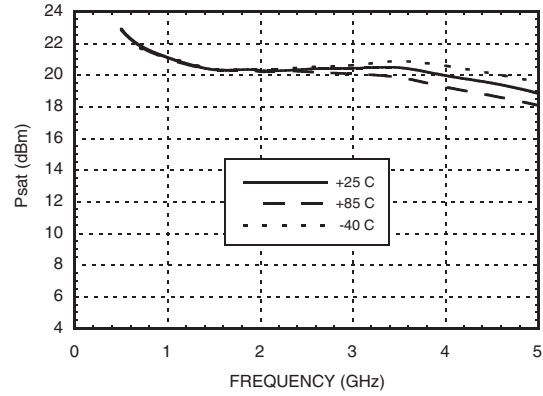

Output IP3 vs. Temperature

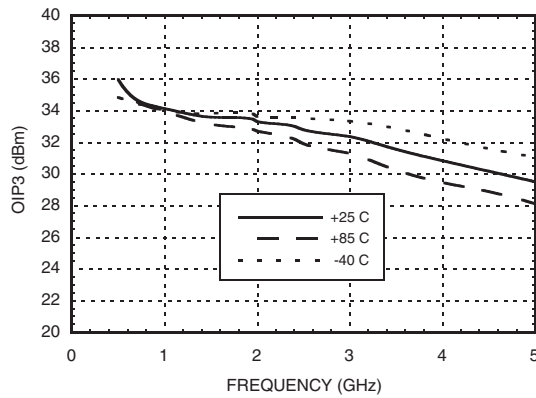

**Gain, Power & OIP3 vs. Supply Voltage
 @ 850 MHz, Rbias= 39 Ohms**

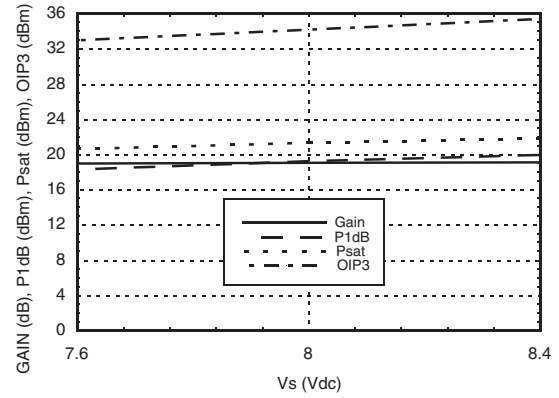

**Vcc vs. Icc Over Temperature for
 Fixed Vs= 8V, RBIAS= 39 Ohms**

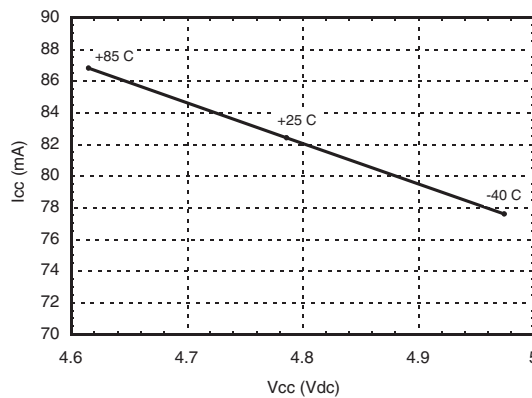



HMC480ST89 / 480ST89E

InGaP HBT GAIN BLOCK MMIC AMPLIFIER, DC - 5 GHz

Absolute Maximum Ratings

Collector Bias Voltage (Vcc)	+6.0 Vdc
RF Input Power (RFIN)(Vcc = +5 Vdc)	+11 dBm
Junction Temperature	150 °C
Continuous Pdiss (T = 85 °C) (derate 8.25 mW/°C above 85 °C)	0.536 W
Thermal Resistance (junction to ground paddle)	122 °C/W
Storage Temperature	-65 to +150 °C
Operating Temperature	-40 to +85 °C



ELECTROSTATIC SENSITIVE DEVICE
OBSERVE HANDLING PRECAUTIONS

Outline Drawing

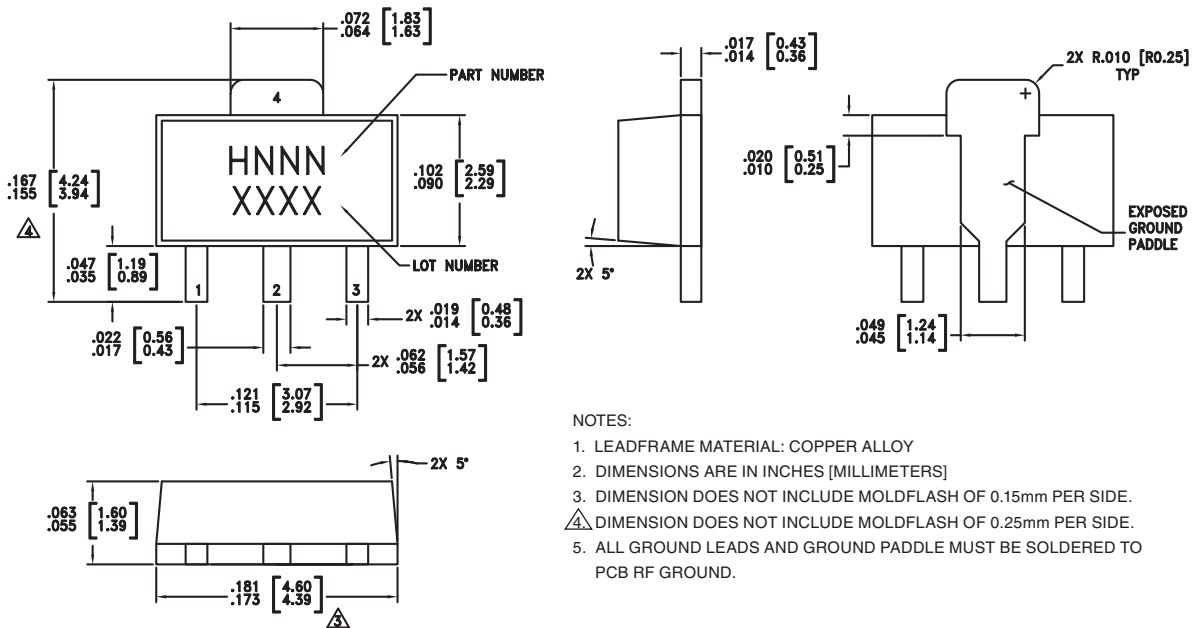

NOTES:

- LEADFRAME MATERIAL: COPPER ALLOY
- DIMENSIONS ARE IN INCHES [MILLIMETERS]
- DIMENSION DOES NOT INCLUDE MOLDFLASH OF 0.15mm PER SIDE.
- DIMENSION DOES NOT INCLUDE MOLDFLASH OF 0.25mm PER SIDE.
- ALL GROUND LEADS AND GROUND PADDLE MUST BE SOLDERED TO PCB RF GROUND.

Package Information

Part Number	Package Body Material	Lead Finish	MSL Rating	Package Marking ^[3]
HMC480ST89	Low Stress Injection Molding Plastic	Sn/Pb Solder	MSL1 ^[1]	H480 XXXX
HMC480ST89E	RoHS-compliant Low Stress Injection Molding Plastic	100% matte Sn	MSL1 ^[2]	<u>H480</u> XXXX

[1] Max peak reflow temperature of 235 °C

[2] Max peak reflow temperature of 260 °C

[3] 4-Digit lot number XXXX



Pin Descriptions

Pin Number	Function	Description	Interface Schematic
1	RFIN	This pin is DC coupled. An off chip DC blocking capacitor is required.	
3	RFOUT	RF output and DC Bias (Vcc) for the output stage.	
2, 4	GND	These pins and package bottom must be connected to RF/DC ground.	

Application Circuit

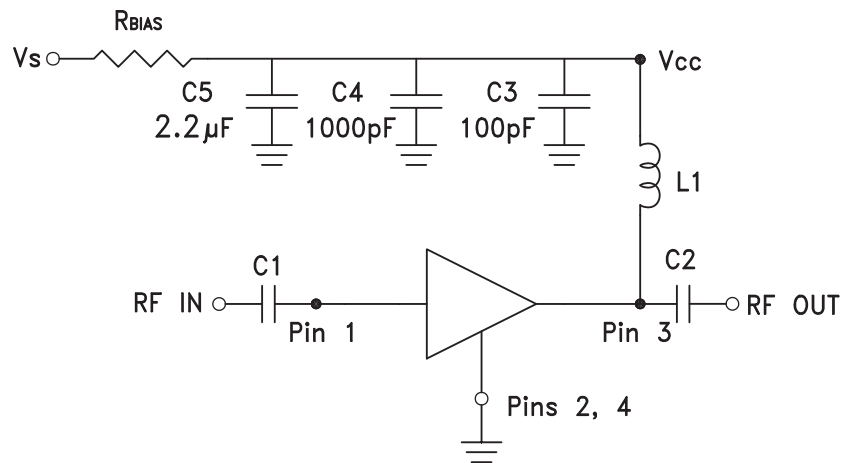

Recommended Bias Resistor Values for $I_{cc} = 82 \text{ mA}$, $R_{bias} = (V_s - V_{cc}) / I_{cc}$

Supply Voltage (V_s)	6V	8V
R_{BIAS} VALUE	12 Ω	39 Ω
R_{BIAS} POWER RATING	1/8 W	1/4 W

Note:

- External blocking capacitors are required on RFIN and RFOUT.
- R_{BIAS} provides DC bias stability over temperature.

Recommended Component Values for Key Application Frequencies

Component	Frequency (MHz)						
	50	900	1900	2200	2400	3500	5000
L1	270 nH	56 nH	18 nH	18 nH	15 nH	8.2 nH	6.8 nH
C1, C2	0.01 μ F	100 pF	100 pF	100 pF	100 pF	100 pF	100 pF



Evaluation PCB

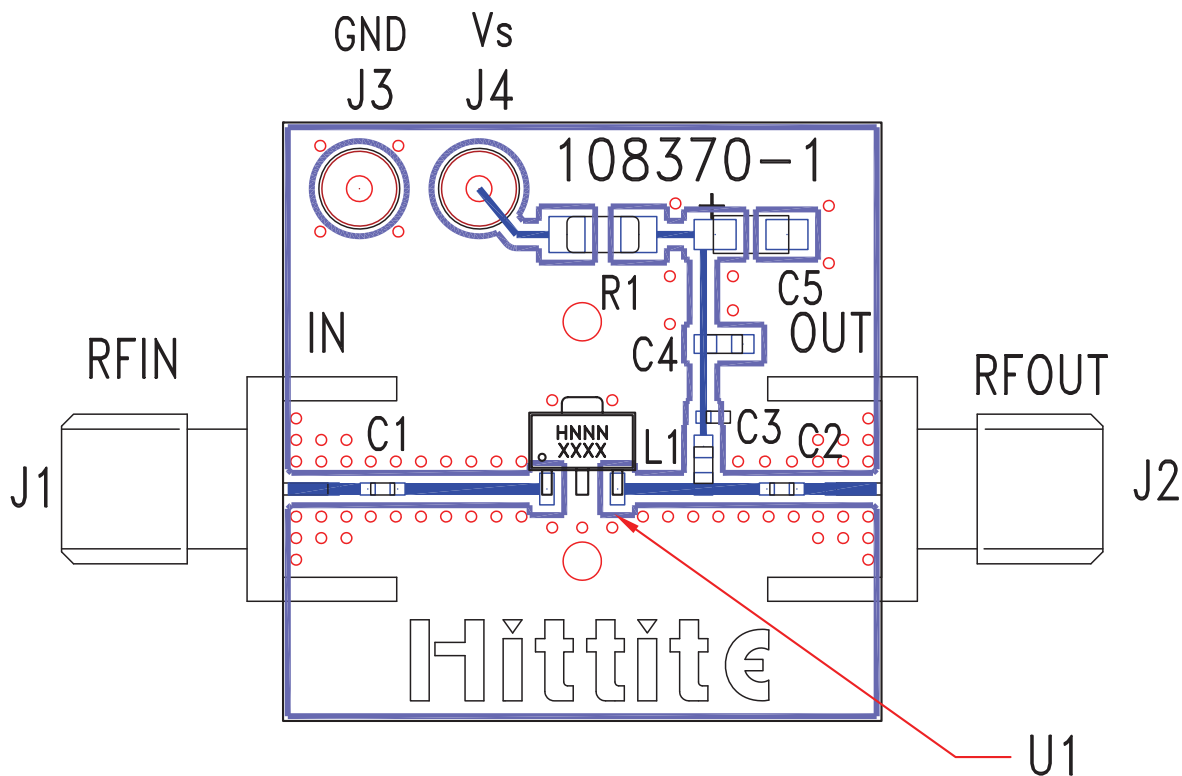

List of Materials for Evaluation PCB 108371 [1]

Item	Description
J1 - J2	PCB Mount SMA Connector
J3 - J4	DC Pin
C1, C2	Capacitor, 0402 Pkg.
C3	100 pF Capacitor, 0402 Pkg.
C4	1000 pF Capacitor, 0603 Pkg.
C5	2.2 μ F Capacitor, Tantalum
R1	Resistor, 1210 Pkg.
L1	Inductor, 0603 Pkg.
U1	HMC480ST89 / HMC480ST89E
PCB [2]	108370 Evaluation PCB

[1] Reference this number when ordering complete evaluation PCB

[2] Circuit Board Material: Rogers 4350

The circuit board used in the final application should use RF circuit design techniques. Signal lines should have 50 ohm impedance while the package ground leads and package bottom should be connected directly to the ground plane similar to that shown. A sufficient number of via holes should be used to connect the top and bottom ground planes. The evaluation board should be mounted to an appropriate heat sink. The evaluation circuit board shown is available from Hittite upon request.