

**GaAs MMIC FUNDAMENTAL  
 MIXER, 11 - 20 GHz**

**Typical Applications**

The HMC554 is ideal for:

- Microwave Radio
- VSAT
- Military & Space
- Communications, Radar & EW

**Features**

- High LO to RF Isolation: 46 dB
- Passive Double Balanced Topology
- Low Conversion Loss: 7 dB
- Wide IF Bandwidth: DC - 6 GHz
- Robust 1,000V ESD, Class 1C
- Small Size: 0.83 x 1.12 x 0.1 mm

**Functional Diagram**

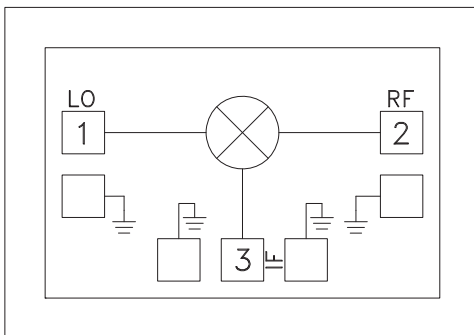

**General Description**

The HMC554 is a passive double balanced mixer that can be used as an upconverter or downconverter between 11 and 20 GHz. The miniature monolithic mixer is fabricated in a GaAs MESFET process, and requires no external components or matching circuitry. The HMC554 provides excellent LO to RF and LO to IF isolation due to optimized balun structures. Measurements were made with the chip mounted into in a 50 ohm test fixture and includes the parasitic effects of wire bond assembly. Connections were made with a 1 mil wire bond with minimal length (<12 mil).

**Electrical Specifications,  $T_A = +25^\circ C$ ,  $IF = 100 MHz$ ,  $LO = +13 dBm^*$**

Parameter	Min.	Typ.	Max.	Min.	Typ.	Max.	Units
Frequency Range, RF & LO	12 - 16			11 - 20			GHz
Frequency Range, IF	DC - 6			DC - 6			GHz
Conversion Loss		7	9		8	10	dB
Noise Figure (SSB)		7	9		8	10	dB
LO to RF Isolation	40	46		38	44		dB
LO to IF Isolation	32	38		30	40		dB
RF to IF Isolation	16	25		15	25		dB
IP3 (Input)		18			18		dBm
IP2 (Input)		48			45		dBm
1 dB Gain Compression (Input)		11			11		dBm

\*Unless otherwise noted, all measurements performed as downconverter,  $IF = 100 MHz$ .

For price, delivery, and to place orders, please contact Hittite Microwave Corporation:

SUNSTAR 微波光电 <http://www.hittite.com> / TEL:0755-83396822 FAX:0755-83376182 E-MAIL: szss20@163.com  
 Order On-line at [www.hittite.com](http://www.hittite.com)

**GaAs MMIC FUNDAMENTAL MIXER, 11 - 20 GHz**

**Conversion Gain vs. Temperature @ LO = +13 dBm**

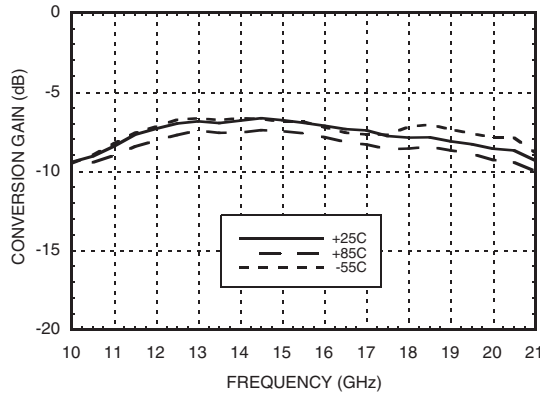

**Isolation @ LO = +13 dBm**

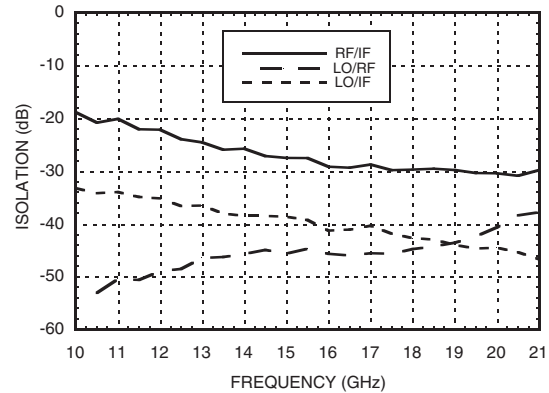

**Conversion Gain vs. LO Drive**

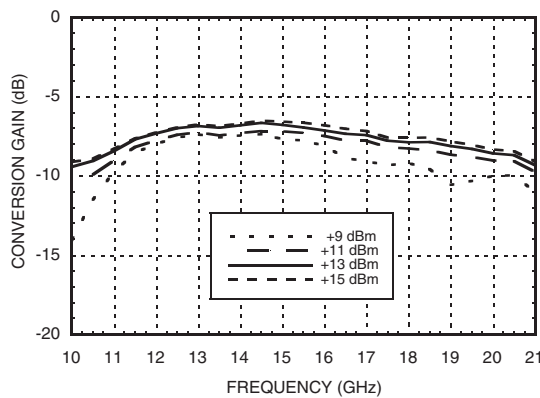

**Return Loss @ LO = +13 dBm**

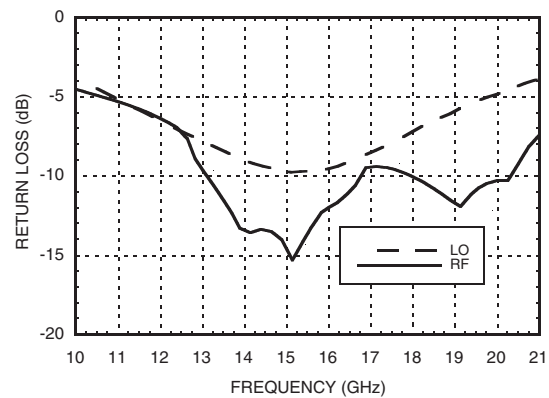

**IF Bandwidth @ LO = +13 dBm**

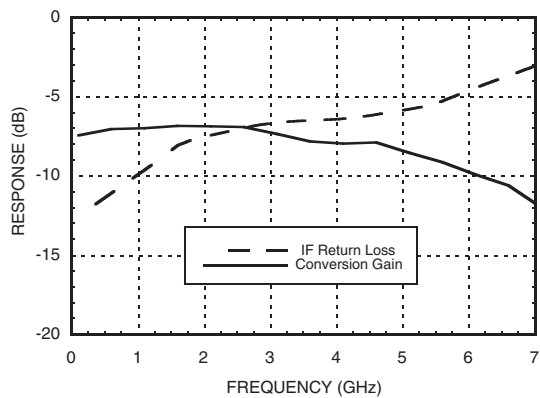

**Upconverter Performance Conversion Gain vs. LO Drive**

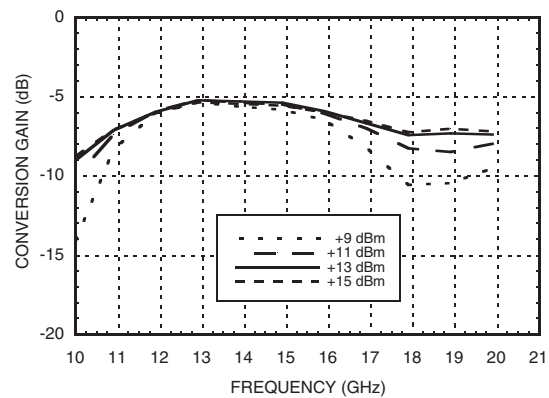

### GaAs MMIC FUNDAMENTAL MIXER, 11 - 20 GHz

**Input IP3 vs. LO Drive \***

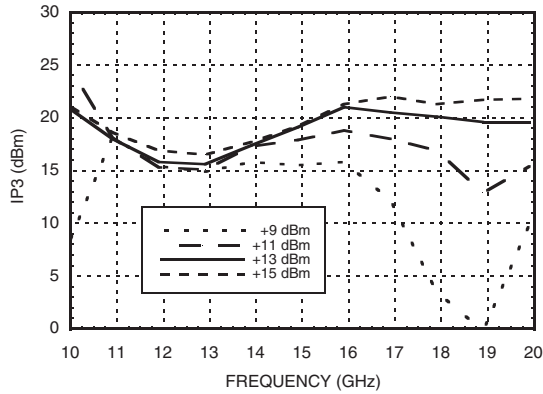

**Input IP3 vs. Temperature @ LO = +13 dBm \***

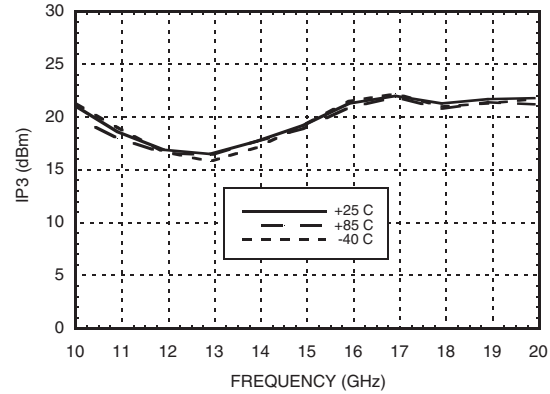

**Input IP2 vs. LO Drive \***

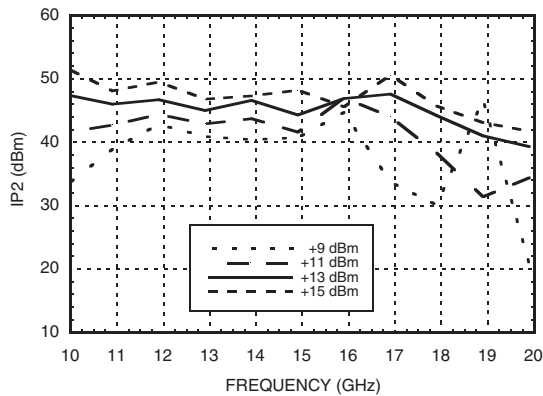

**Input IP2 vs. Temperature @ LO = +13 dBm \***

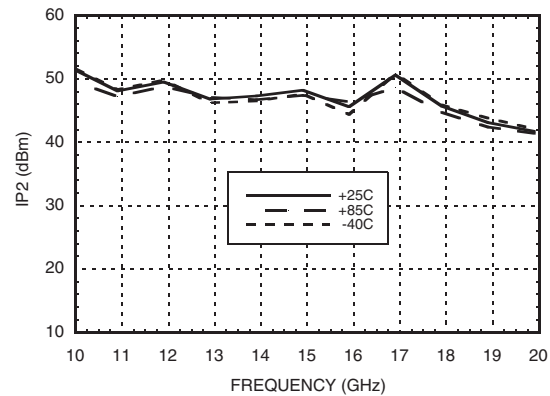

**Input P1dB vs. Temperature @ LO = +13 dBm**

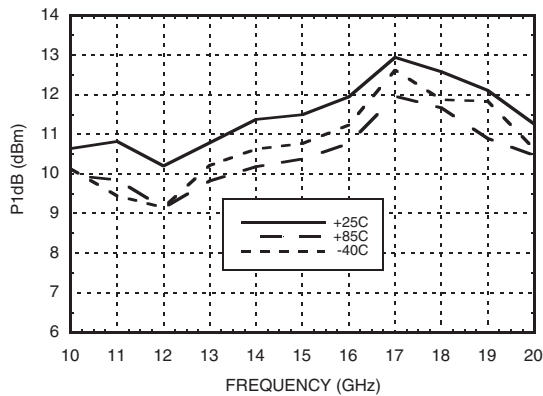

**MxN Spurious Outputs**

mRF	nLO				
	0	1	2	3	4
0	xx	19	25	xx	xx
1	29	0	51	55	xx
2	81	85	60	88	104
3	xx	97	98	76	99
4	xx	xx	105	98	105

RF = 15.1 GHz @ -10 dBm  
 LO = 15.0 GHz @ +13 dBm  
 All values in dBc below the IF output power level.

\* Two-tone input power = -5 dBm each tone, 1 MHz spacing.



**Hittite**  
MICROWAVE CORPORATION

v02.1007

# HMC554

## GaAs MMIC FUNDAMENTAL MIXER, 11 - 20 GHz

### Absolute Maximum Ratings

RF / IF Input	+25 dBm
LO Drive	+25 dBm
Channel Temperature	150 °C
Continuous Pdiss (T = 85 °C) (derate 3.26 mW/°C above 85 °C)	212 mW
Thermal Resistance (channel to die bottom)	306 °C/W
Storage Temperature	-65 to +150 °C
Operating Temperature	-55 to +85 °C
ESD Sensitivity (HBM)	Class 1C



ELECTROSTATIC SENSITIVE DEVICE  
OBSERVE HANDLING PRECAUTIONS

### Outline Drawing

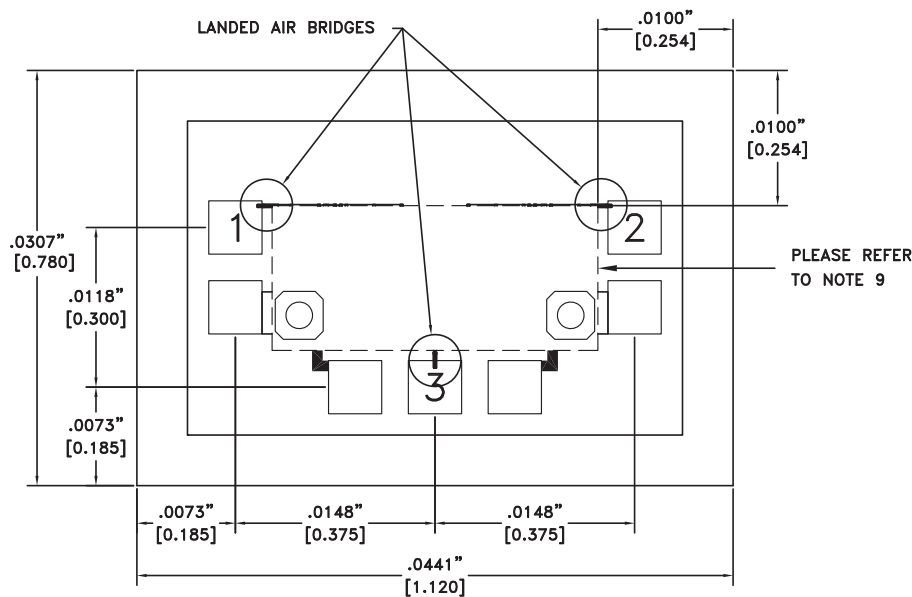

### Die Packaging Information [1]

Standard	Alternate
WP-7 (Waffle Pack)	[2]

[1] Refer to the "Packaging Information" section for die packaging dimensions.



[2] For alternate packaging information contact Hittite Microwave Corporation.

#### NOTES:

1. ALL DIMENSIONS ARE IN INCHES [MM].
2. DIE THICKNESS IS .004".
3. TYPICAL BOND PAD IS .004" SQUARE.
4. BOND PAD SPACING CENTER TO CENTER IS .006".
5. BACKSIDE METALLIZATION: GOLD.
6. BOND PAD METALLIZATION: GOLD.
7. BACKSIDE METAL IS GROUND.
8. CONNECTION NOT REQUIRED FOR UNLABELED BOND PADS.
9. THIS DIE IS DESIGNED FOR PICK-UP WITH VACUUM (EDGE) COLLET TOOLS. TO PRECLUDE THE RISK OF PERMANENT DAMAGE, NO CONTACT TO THE DIE SURFACE IS ALLOWED WITHIN THIS RECTANGULAR AREA.

## GaAs MMIC FUNDAMENTAL MIXER, 11 - 20 GHz

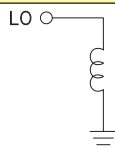
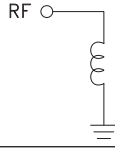
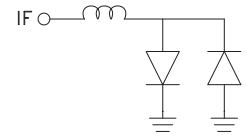
### Pad Descriptions

Pad Number	Function	Description	Interface Schematic
1	LO	This pad is DC coupled and matched to 50 Ohms.	
2	RF	This pad is DC coupled and matched to 50 Ohms.	
3	IF	This pad is DC coupled. For applications not requiring operation to DC, this port should be DC blocked externally using a series capacitor whose value has been chosen to pass the necessary IF frequency range. For operation to DC, this pin must not source or sink more than 2 mA of current or part non-function and possible part failure will result.	
	GND	The backside of the die must be connected to RF ground.	

### Assembly Drawing

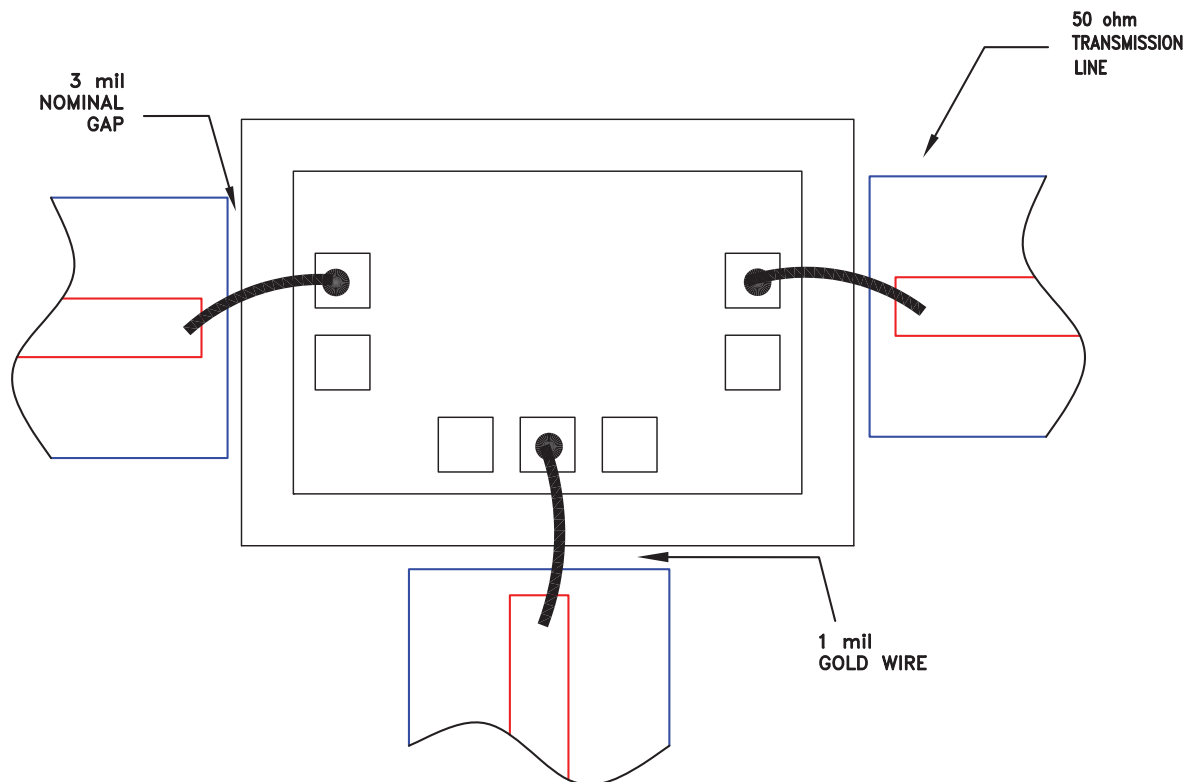

For price, delivery, and to place orders, please contact Hittite Microwave Corporation:

SUNSTAR 微波光电 <http://www.rfmic.com> / TEL:0755-83396822 FAX:0755-83376182 E-MAIL: szss20@163.com  
Order On-line at [www.hittite.com](http://www.hittite.com)

**GaAs MMIC FUNDAMENTAL  
MIXER, 11 - 20 GHz**

**Mounting & Bonding Techniques for Millimeterwave GaAs MMICs**

The die should be attached directly to the ground plane eutectically or with conductive epoxy (see HMC general Handling, Mounting, Bonding Note).

50 Ohm Microstrip transmission lines on 0.127mm (5 mil) thick alumina thin film substrates are recommended for bringing RF to and from the chip (Figure 1). If 0.254mm (10 mil) thick alumina thin film substrates must be used, the die should be raised 0.150mm (6 mils) so that the surface of the die is coplanar with the surface of the substrate. One way to accomplish this is to attach the 0.102mm (4 mil) thick die to a 0.150mm (6 mil) thick molybdenum heat spreader (moly-tab) which is then attached to the ground plane (Figure 2).

Microstrip substrates should be brought as close to the die as possible in order to minimize ribbon bond length. Typical die-to-substrate spacing is 0.076mm (3 mils). Gold ribbon of 0.075 mm (3 mil) width and minimal length <0.31 mm (<12 mils) is recommended to minimize inductance on RF, LO & IF ports.

**Handling Precautions**

Follow these precautions to avoid permanent damage.

**Storage:** All bare die are placed in either Waffle or Gel based ESD protective containers, and then sealed in an ESD protective bag for shipment. Once the sealed ESD protective bag has been opened, all die should be stored in a dry nitrogen environment.

**Cleanliness:** Handle the chips in a clean environment. DO NOT attempt to clean the chip using liquid cleaning systems.

**Static Sensitivity:** Follow ESD precautions to protect against ESD strikes.

**Transients:** Suppress instrument and bias supply transients while bias is applied. Use shielded signal and bias cables to minimize inductive pick-up.

**General Handling:** Handle the chip along the edges with a vacuum collet or with a sharp pair of bent tweezers. The surface of the chip has fragile air bridges and should not be touched with vacuum collet, tweezers, or fingers.

**Mounting**

The chip is back-metallized and can be die mounted with AuSn eutectic preforms or with electrically conductive epoxy. The mounting surface should be clean and flat.

**Eutectic Die Attach:** A 80/20 gold tin preform is recommended with a work surface temperature of 255 °C and a tool temperature of 265 °C. When hot 90/10 nitrogen/hydrogen gas is applied, tool tip temperature should be 290 °C. DO NOT expose the chip to a temperature greater than 320 °C for more than 20 seconds. No more than 3 seconds of scrubbing should be required for attachment.

**Epoxy Die Attach:** Apply a minimum amount of epoxy to the mounting surface so that a thin epoxy fillet is observed around the perimeter of the chip once it is placed into position. Cure epoxy per the manufacturer's schedule.

**Wire Bonding**

Ball or wedge bond with 0.025 mm (1 mil) diameter pure gold wire is recommended. Thermosonic wirebonding with a nominal stage temperature of 150 °C and a ball bonding force of 40 to 50 grams or wedge bonding force of 18 to 22 grams is recommended. Use the minimum level of ultrasonic energy to achieve reliable wirebonds. Wirebonds should be started on the chip and terminated on the package or substrate. All bonds should be as short as possible <0.31 mm (12 mils).

