



GaAs MMIC ANALOG VARIABLE GAIN AMPLIFIER, 6 - 17 GHz

Typical Applications

The HMC694 is ideal for:

- Point-to-Point Radio
- Point-to-Multi-Point Radio
- EW & ECM
- X-Band Radar
- Test Equipment

Features

- Wide Gain Control Range: 23 dB
- Single Control Voltage
- Output IP3 @ Max Gain: +30 dBm
- Output P1dB: +22 dBm
- No External Matching
- Die Size: 2.26 x 0.97 x 0.1 mm

Functional Diagram

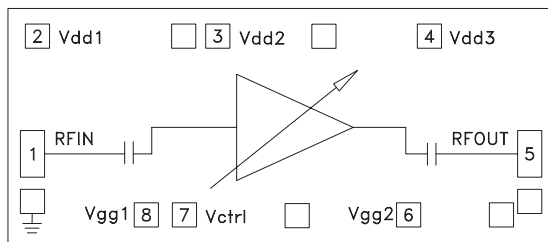

General Description

The HMC694 is a GaAs MMIC PHEMT analog variable gain amplifier die which operates between 6 and 17 GHz. Ideal for microwave radio applications, the amplifier provides up to 24 dB of gain, output P1dB of up to 22 dBm, and up to 30 dBm of Output IP3 at maximum gain, while requiring only 170 mA from a +5V supply. A gate bias (Vctrl) is provided to allow variable gain control up to 23 dB. Gain flatness is excellent from 6 to 17 GHz, making the HMC694 ideal for EW, ECM and radar applications. The HMC694 can easily be integrated into Multi-Chip-Modules (MCMs) due to its small size and no external matching. All data is taken with the chip in a 50 Ohm test fixture connected via 0.025 mm (1 mil) diameter wire bonds of minimal length 0.31 mm (12 mils).

Electrical Specifications, $T_A = +25^\circ C$, Vdd1, 2, 3= 5V, Vctrl= -2V, Idd= 170 mA*

| Parameter | Min. | Typ. | Max. | Min. | Typ. | Max. | Units |
|--|--------|------|---------|------|------|------|--------|
| Frequency Range | 6 - 10 | | 10 - 17 | | | | GHz |
| Gain | 19 | 24 | | 17 | 21 | | dB |
| Gain Flatness | | ±1 | | | ±1.5 | | dB |
| Gain Variation Over Temperature | | 0.03 | | | 0.03 | | dB/ °C |
| Gain Control Range | | 23 | | | 20 | | dB |
| Noise Figure | | 5.5 | 7.5 | | 5 | 6.5 | dB |
| Input Return Loss | | 15 | | | 12 | | dB |
| Output Return Loss | | 10 | | | 8 | | dB |
| Output Power for 1 dB Compression (P1dB) | 19 | 21 | | 21 | 22 | | dBm |
| Saturated Output Power (Psat) | | 22 | | | 23 | | dBm |
| Output Third Order Intercept (IP3) | | 30 | | | 30 | | dBm |
| Total Supply Current (Idd) | | 170 | | | 170 | | mA |

*Set Vctrl = -2V and then adjust Vgg1, 2 between -2V to 0V (typ. -0.8V) to achieve Idd = 170mA typical.

For price, delivery, and to place orders, please contact Hittite Microwave Corporation:

SUNSTAR 微波光电 <http://www.hittite.com> / TEL:0755-83396822 FAX:0755-83376182 E-MAIL: szss20@163.com
Order On-line at www.hittite.com



GaAs MMIC ANALOG VARIABLE GAIN AMPLIFIER, 6 - 17 GHz

Control Voltage Range vs. Gain

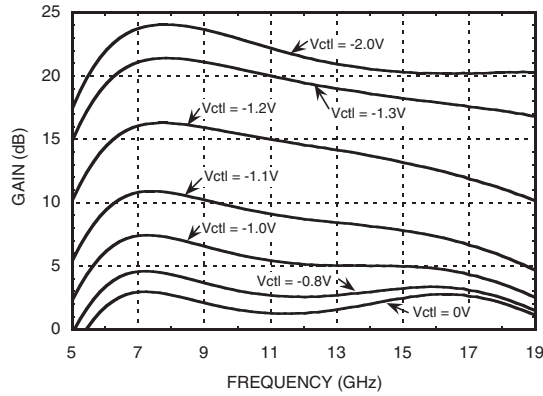

Gain vs. Control Voltage

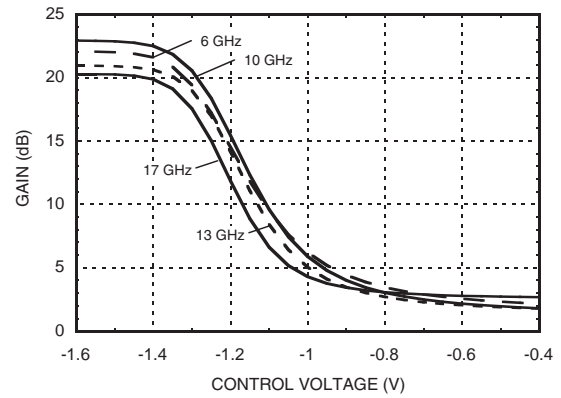

Broadband Gain & Return Loss

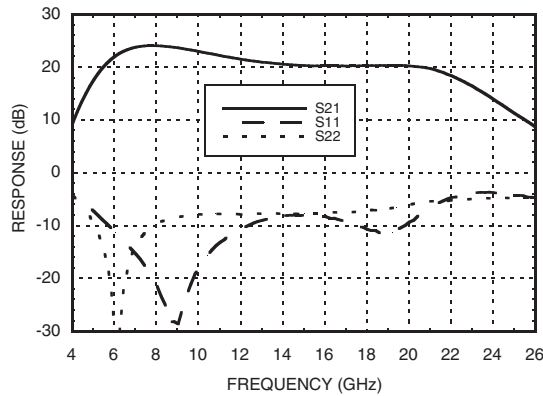

Gain vs. Temperature

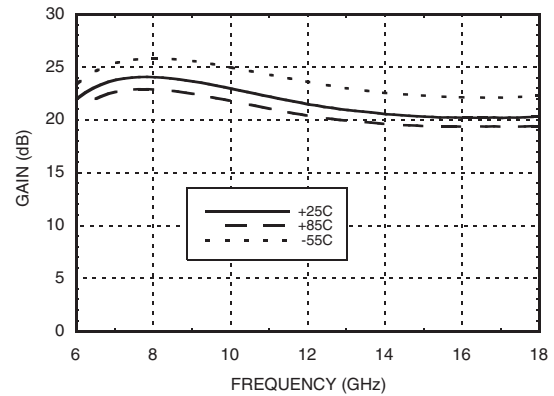

Input Return Loss vs. Temperature

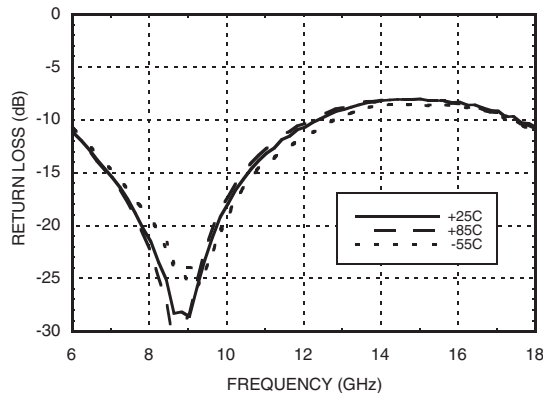

Output Return Loss vs. Temperature

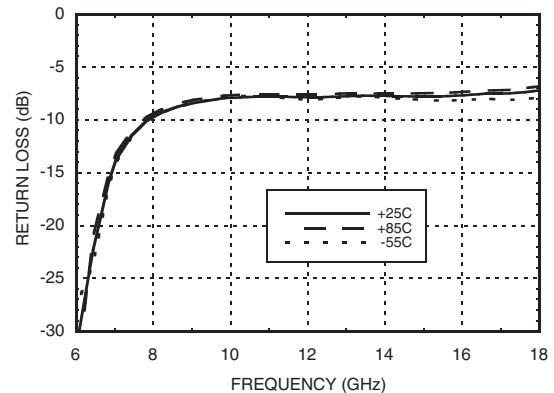



GaAs MMIC ANALOG VARIABLE GAIN AMPLIFIER, 6 - 17 GHz

Return Loss @ Voltage Extreme

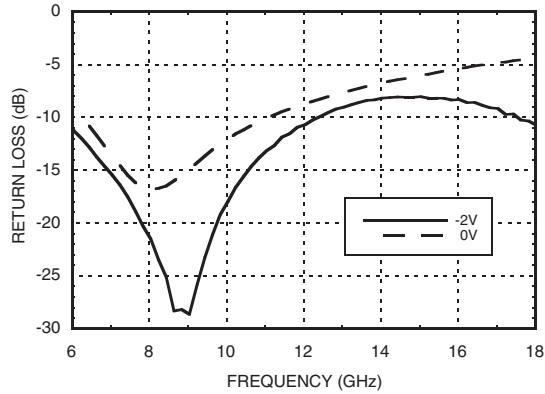

Output Return Loss @ Voltage Extreme

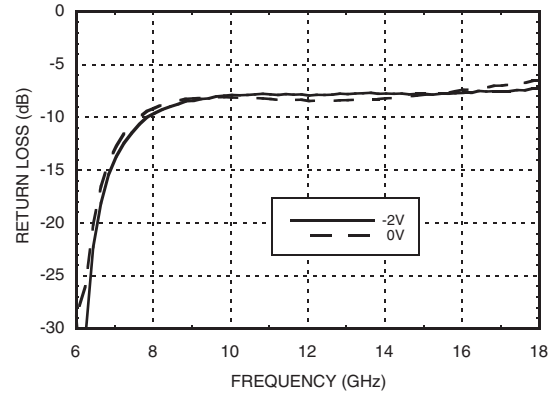

Noise Figure vs. Temperature

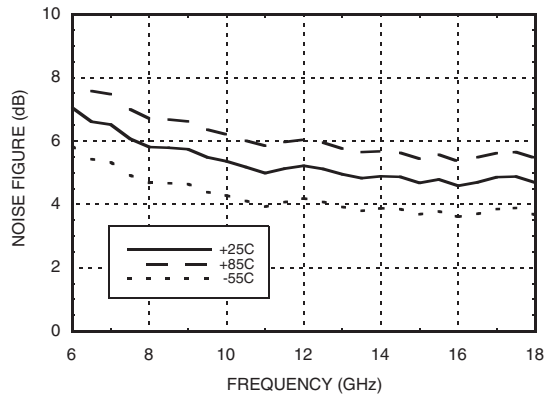

Noise Figure vs. CTRL

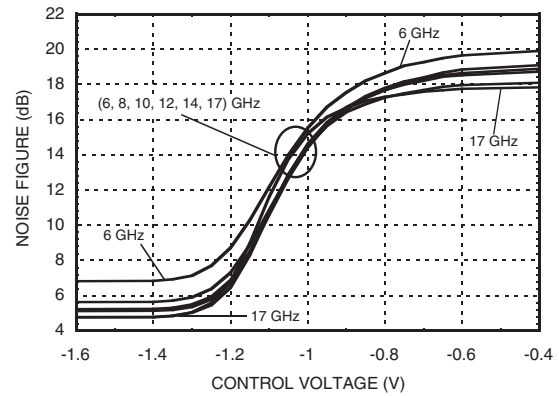

P1dB vs. Temperature

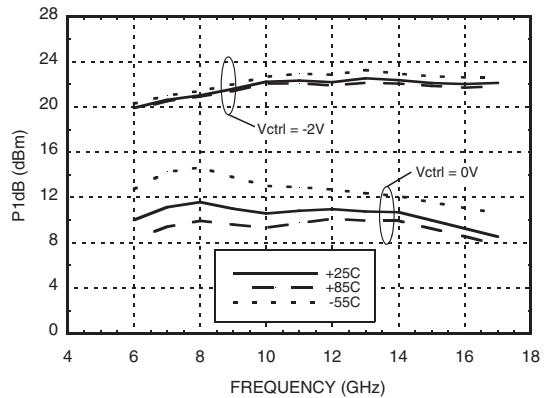

Psat vs. Temperature

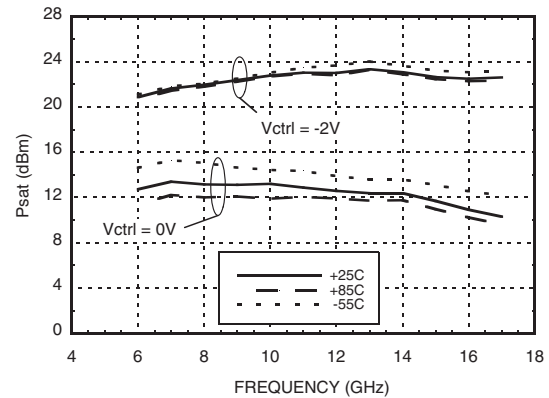



GaAs MMIC ANALOG VARIABLE GAIN AMPLIFIER, 6 - 17 GHz

Reverse Isolation vs. Temperature

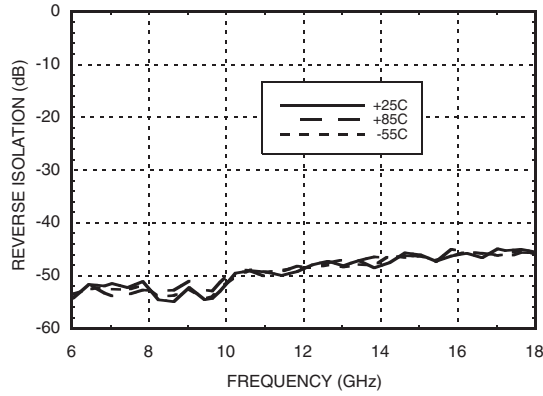

Output IP3 vs. Temperature

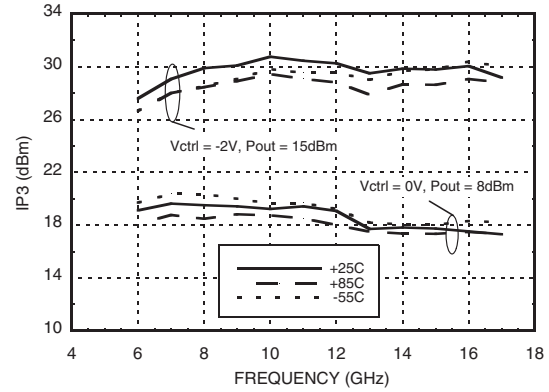

Output IP3 @ 0 dBm

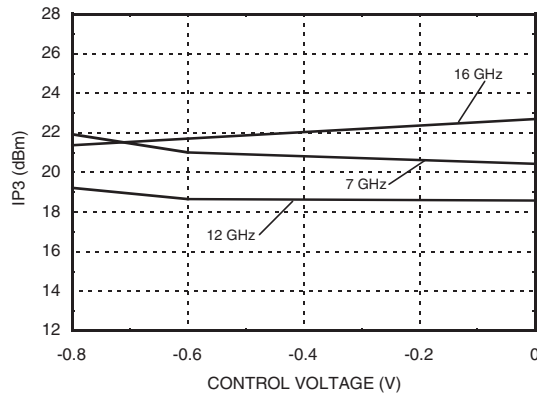

Output IP3 @ 5 dBm

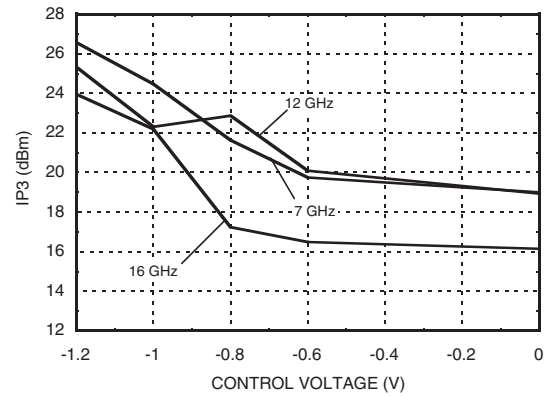

Output IP3 @ 10 dBm

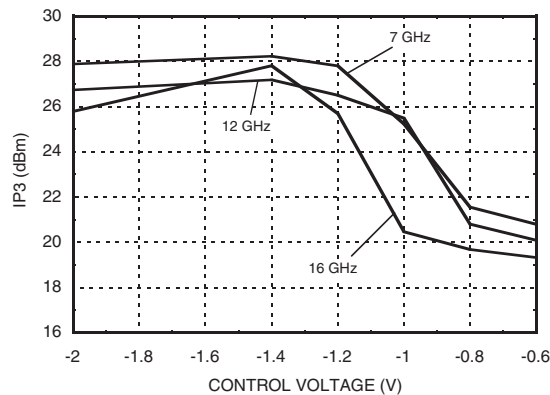



GaAs MMIC ANALOG VARIABLE GAIN AMPLIFIER, 6 - 17 GHz

Absolute Maximum Ratings

| | |
|--|----------------|
| Drain Bias Voltage (Vdd1, 2, 3) | +5.5V |
| Gate Bias Voltage (Vgg1, 2) | -3 to 0V |
| Gain Control Voltage (Vctrl) | -3 to 0V |
| RF Input Power | +5 dBm |
| Channel Temperature | 175 °C |
| Continuous P _{diss} (T= 85 °C) (derate 10.2 mW/°C above 85 °C) | 0.92 W |
| Thermal Resistance (channel to die bottom) | 97.6 °C/W |
| Storage Temperature | -65 to +150 °C |
| Operating Temperature | -55 to +85 °C |

Typical Supply Current vs. Vdd

| | |
|--------------|----------------------------|
| Vdd1,2,3 (V) | I _{dd} Total (mA) |
| +5.0 | 170 |
| Vgg1,2 (V) | I _{gg} Total (mA) |
| 0V to -2V | <3 μA |



ELECTROSTATIC SENSITIVE DEVICE
OBSERVE HANDLING PRECAUTIONS

Outline Drawing

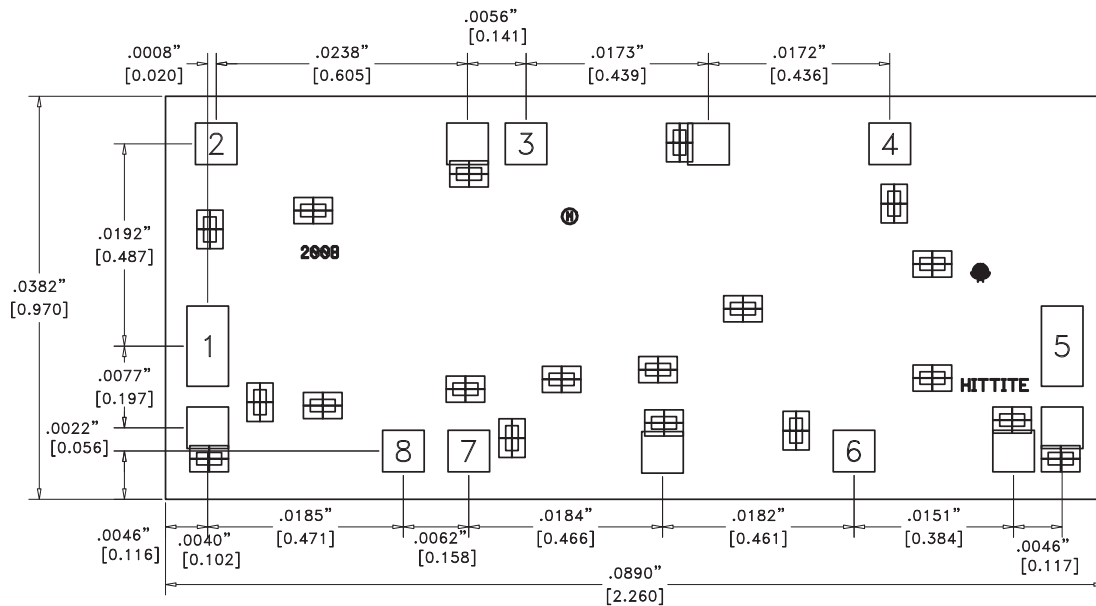

Die Packaging Information [1]

| Standard | Alternate |
|----------|-----------|
| GP-2 | [2] |

[1] Refer to the "Packaging Information" section for die packaging dimensions.

[2] For alternate packaging information contact Hittite Microwave Corporation.

NOTES:

1. ALL DIMENSIONS IN INCHES [MILLIMETERS]
2. NO CONNECTION REQUIRED FOR UNLABELED BOND PADS
3. DIE THICKNESS IS 0.004 (0.100)
4. TYPICAL BOND PAD IS 0.004 (0.100) SQUARE
5. BACKSIDE METALLIZATION: GOLD
6. BACKSIDE METAL IS GROUND
7. BOND PAD METALIZATION: GOLD

For price, delivery, and to place orders, please contact Hittite Microwave Corporation:

SUNSTAR 微波光电 <http://www.hittite.com> / TEL:0755-83396822 FAX:0755-83376182 E-MAIL: szss20@163.com
Order On-line at www.hittite.com



GaAs MMIC ANALOG VARIABLE GAIN AMPLIFIER, 6 - 17 GHz

Pad Descriptions

| Pad Number | Function | Description | Interface Schematic |
|------------|------------|---|---------------------|
| 1 | RFIN | This pad is AC coupled and matched to 50 ohm. | |
| 2 - 4 | Vdd1, 2, 3 | Drain Bias Voltage for the amplifier. See assembly diagram for required external components | |
| 5 | RFOUT | This pad is AC coupled and matched to 50 ohm. | |
| 6, 8 | Vgg1, 2 | Gate control for amplifier. Adjust voltage to achieve typical Idd. Please follow "MMIC Amplifier Biasing Procedure" application note. | |
| 7 | Vctrl | Gain control Voltage for the amplifier. See assembly diagram for required external components. | |
| Die Bottom | GND | Die bottom must be connected to RF/DC ground. | |



GaAs MMIC ANALOG VARIABLE GAIN AMPLIFIER, 6 - 17 GHz

Assembly Diagram

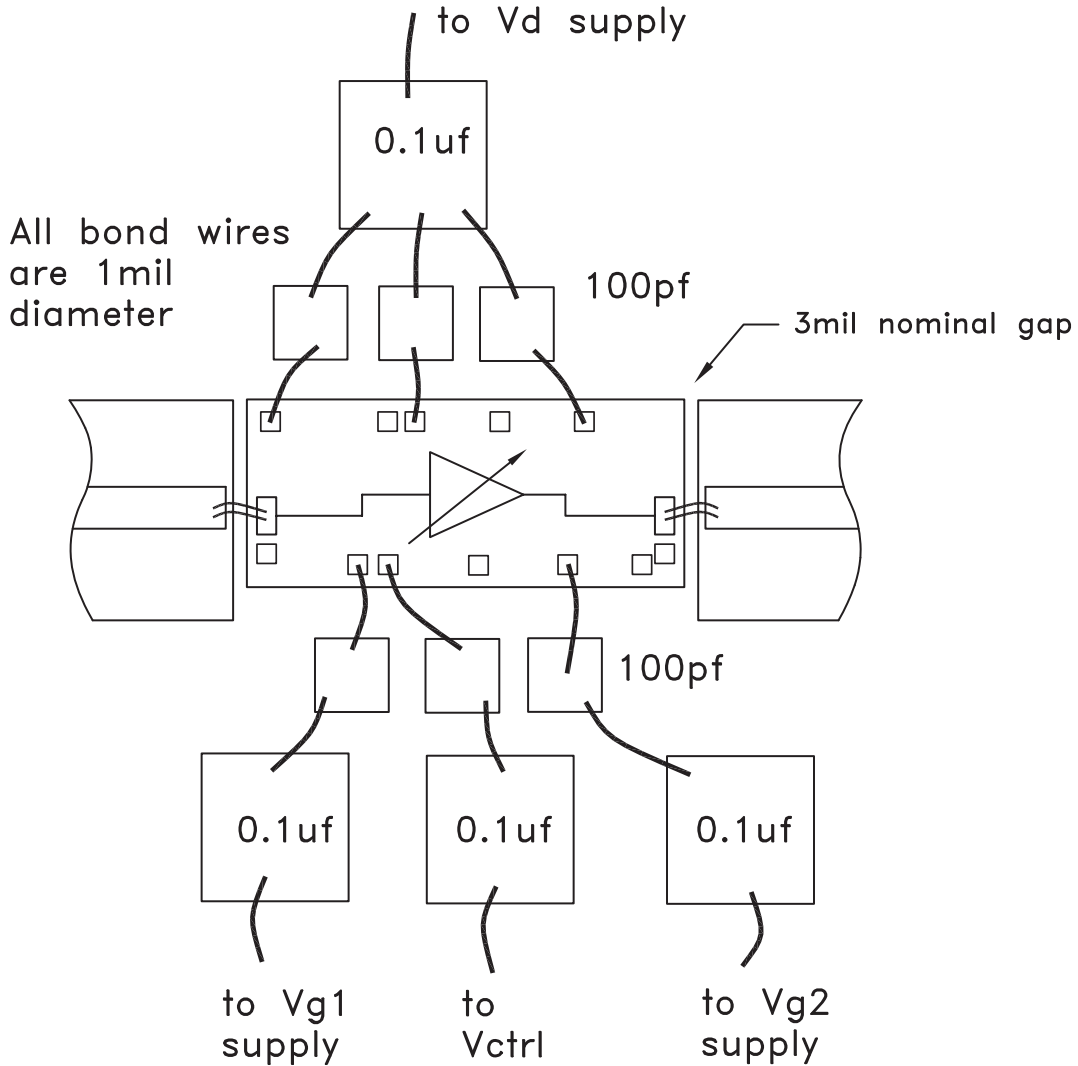



GaAs MMIC ANALOG VARIABLE GAIN AMPLIFIER, 6 - 17 GHz

Mounting & Bonding Techniques for Millimeterwave GaAs MMICs

The die should be attached directly to the ground plane eutectically or with conductive epoxy (see HMC general Handling, Mounting, Bonding Note).

50 Ohm Microstrip transmission lines on 0.127mm (5 mil) thick alumina thin film substrates are recommended for bringing RF to and from the chip (Figure 1). If 0.254mm (10 mil) thick alumina thin film substrates must be used, the die should be raised 0.150mm (6 mils) so that the surface of the die is coplanar with the surface of the substrate. One way to accomplish this is to attach the 0.102mm (4 mil) thick die to a 0.150mm (6 mil) thick molybdenum heat spreader (moly-tab) which is then attached to the ground plane (Figure 2).

Microstrip substrates should be placed as close to the die as possible in order to minimize bond wire length. Typical die-to-substrate spacing is 0.076mm to 0.152 mm (3 to 6 mils).

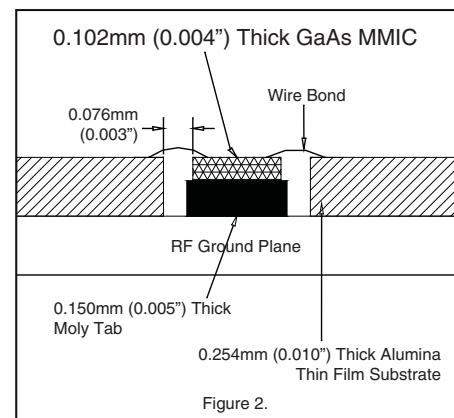
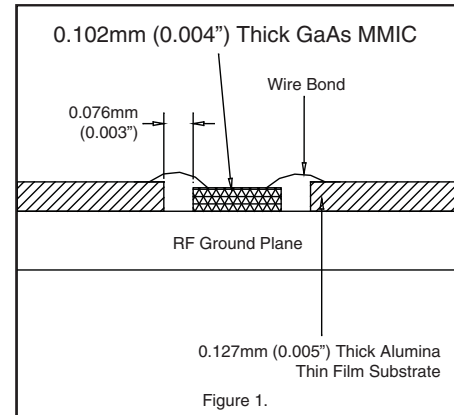

Handling Precautions

Follow these precautions to avoid permanent damage.

Storage: All bare die are placed in either Waffle or Gel based ESD protective containers, and then sealed in an ESD protective bag for shipment. Once the sealed ESD protective bag has been opened, all die should be stored in a dry nitrogen environment.

Cleanliness: Handle the chips in a clean environment. DO NOT attempt to clean the chip using liquid cleaning systems.

Static Sensitivity: Follow ESD precautions to protect against ESD strikes.

Transients: Suppress instrument and bias supply transients while bias is applied. Use shielded signal and bias cables to minimize inductive pick-up.

General Handling: Handle the chip along the edges with a vacuum collet or with a sharp pair of bent tweezers. The surface of the chip has fragile air bridges and should not be touched with vacuum collet, tweezers, or fingers.

Mounting

The chip is back-metallized and can be die mounted with AuSn eutectic preforms or with electrically conductive epoxy. The mounting surface should be clean and flat.

Eutectic Die Attach: A 80/20 gold tin preform is recommended with a work surface temperature of 255 °C and a tool temperature of 265 °C. When hot 90/10 nitrogen/hydrogen gas is applied, tool tip temperature should be 290 °C. DO NOT expose the chip to a temperature greater than 320 °C for more than 20 seconds. No more than 3 seconds of scrubbing should be required for attachment.

Epoxy Die Attach: Apply a minimum amount of epoxy to the mounting surface so that a thin epoxy fillet is observed around the perimeter of the chip once it is placed into position. Cure epoxy per the manufacturer's schedule.

Wire Bonding

RF bonds made with two 1 mil wires are recommended. These bonds should be thermosonically bonded with a force of 40-60 grams. DC bonds of 0.001" (0.025 mm) diameter, thermosonically bonded, are recommended. Ball bonds should be made with a force of 40-50 grams and wedge bonds at 18-22 grams. All bonds should be made with a nominal stage temperature of 150 °C. A minimum amount of ultrasonic energy should be applied to achieve reliable bonds. All bonds should be as short as possible, less than 12 mils (0.31 mm).