

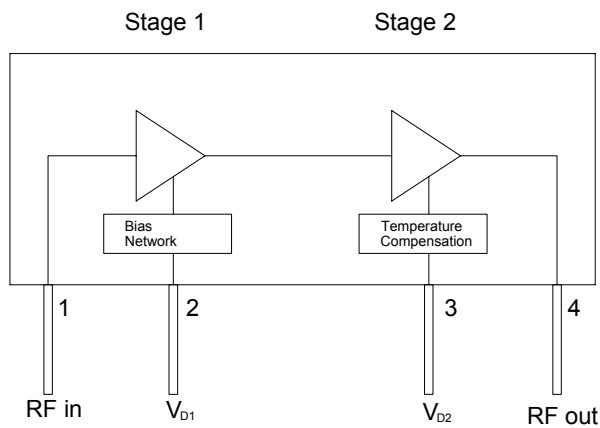

## Product Description

Sirenza Microdevices' **XD010-14S-D4F** 15W power module is a robust 2-stage Class A/AB amplifier module for use in GSM and EDGE RF applications. This module is optimized to minimize the EVM at typical operating levels. The power transistors are fabricated using Sirenza's latest, high performance LDMOS process. This unit operates from a single voltage supply and has internal temperature compensation of the bias voltage to ensure stable performance over the full temperature range. It is a drop-in, no-tune solution for medium power applications requiring high efficiency, excellent linearity, and unit-to-unit repeatability. It is internally matched to 50 ohms.

## Functional Block Diagram



Case Flange = Ground

## XD010-14S-D4F

**925-960 MHz Class A/AB  
15W Power Amplifier Module**

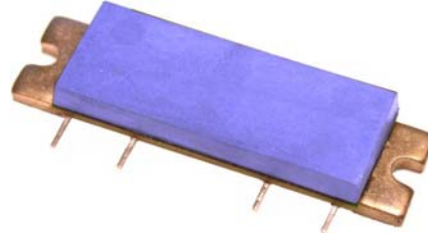

## Product Features

- 50  $\Omega$  RF impedance
- 15W Output  $P_{1dB}$
- Single Supply Operation : Nominally 28V
- High Gain: 32 dB at 942 MHz
- High Efficiency: 31% at 942 MHz
- Robust 8000V ESD (HBM), Class 3B
- High Peak Power for Lower BER
- Ultra-low EVM

## Applications

- Base Station PA driver
- Repeater
- GSM / EDGE

## Key Specifications

Symbol	Parameter	Unit	Min.	Typ.	Max.
Frequency	Frequency of Operation	MHz	925		960
$P_{1dB}$	Output Power at 1dB Compression (single tone)	W	10	15	
Gain	Gain at 12W Output Power (CW)	dB	30	32	35
Gain Flatness	Peak-to-Peak Gain Variation	dB		0.4	1.0
IRL	Input Return Loss 12W CW	dB	12	18	
Efficiency	Drain Efficiency at 12W CW	%	27	31	
Linearity	RMS EVM at 8W EDGE output	%		2.5	
	Peak EVM at 8W EDGE output	%		6.7	
	3 <sup>rd</sup> Order IMD at 12W PEP (Two Tone)	dBc		-35	-30
Delay	Signal Delay from Pin 1 to Pin 4	nS		2.5	
Phase Linearity	Deviation from Linear Phase (Peak-to-Peak)	Deg		0.5	
$R_{TH, j1}$	Thermal Resistance Stage 1 (Junction-to-Case)	$^{\circ}C/W$		11	
$R_{TH, j2}$	Thermal Resistance Stage 2 (Junction-to-Case)	$^{\circ}C/W$		4	

Test Conditions  $Z_{in} = Z_{out} = 50\Omega$ ,  $V_{DD} = 28.0V$ ,  $I_{DQ1} = 230$  mA,  $I_{DQ2} = 158$  mA,  $T_{Flange} = 25^{\circ}C$



## XD010-14S-D4F 925-960 MHz 15W Power Amp Module

### Quality Specifications

Parameter		Unit	Typical
ESD Rating	Human Body Model, JEDEC Document - JESD22-A114-B	V	8000
MTTF	85°C Leadframe, 200°C Channel	Hours	1.2 X 10 <sup>6</sup>

### Pin Description

Pin #	Function	Description
1	RF Input	Module RF input. This pin is internally connected to DC ground. Do not apply DC voltages to the RF leads. Care must be taken to protect against video transients that may damage the active devices.
2	V <sub>D1</sub>	This is the drain voltage for the first stage. Nominally +28Vdc
3	V <sub>D2</sub>	This is the drain voltage for the 2 <sup>nd</sup> stage of the amplifier module. The 2 <sup>nd</sup> stage gate bias is temperature compensated to maintain constant quiescent drain current over the operating temperature range. See Note 1.
4	RF Output	Module RF output. This pin is internally connected to DC ground. Do not apply DC voltages to the RF leads. Care must be taken to protect against video transients that may damage the active devices.
Flange	Gnd	Exposed area on the bottom side of the package needs to be mechanically attached to the ground plane of the board for optimum thermal and RF performance. See mounting instructions in application note AN-060 on Sirenza's web site.

### Simplified Device Schematic

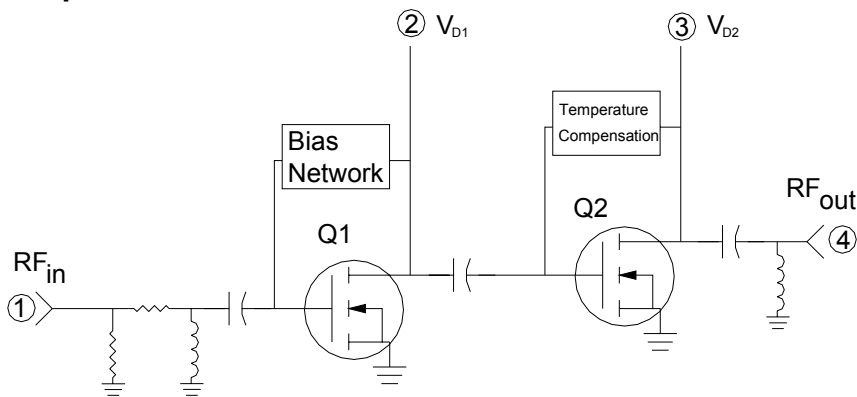

Case Flange = Ground

### Absolute Maximum Ratings

Parameters	Value	Unit
1 <sup>st</sup> Stage Bias Voltage (V <sub>D1</sub> )	35	V
2 <sup>nd</sup> Stage Bias Voltage (V <sub>D2</sub> )	35	V
RF Input Power	+20	dBm
Load Impedance for Continuous Operation Without Damage	5:1	VSWR
Output Device Channel Temperature	+200	°C
Operating Temperature Range	-20 to +90	°C
Storage Temperature Range	-40 to +100	°C

**Operation of this device beyond any one of these limits may cause permanent damage. For reliable continuous operation see typical setup values specified in the table on page one.**

#### Note 1:

The internally generated gate voltage is thermally compensated to maintain constant quiescent current over the temperature range listed in the data sheet. No compensation is provided for gain changes with temperature. This can only be accomplished with AGC external to the module.

#### Note 2:

Internal RF decoupling is included on all bias leads. No additional bypass elements are required, however some applications may require energy storage on the drain leads to accommodate time-varying waveforms.

#### Note 3:

This module was designed to have its leads hand soldered to an adjacent PCB. The maximum soldering iron tip temperature should not exceed 700° C, and the soldering iron tip should not be in direct contact with the lead for longer than 10 seconds. Refer to app note AN060 ([www.sirenza.com](http://www.sirenza.com)) for further installation instructions.



#### Caution: ESD Sensitive

Appropriate precaution in handling, packaging and testing devices must be observed.

303 S. Technology Court  
Broomfield, CO 80021

Phone: (800) SMI-MMIC  
2

<http://www.sirenza.com>  
EDS-102936 Rev E



**XD010-14S-D4F 925-960 MHz 15W Power Amp Module**

**Typical Performance Curves**

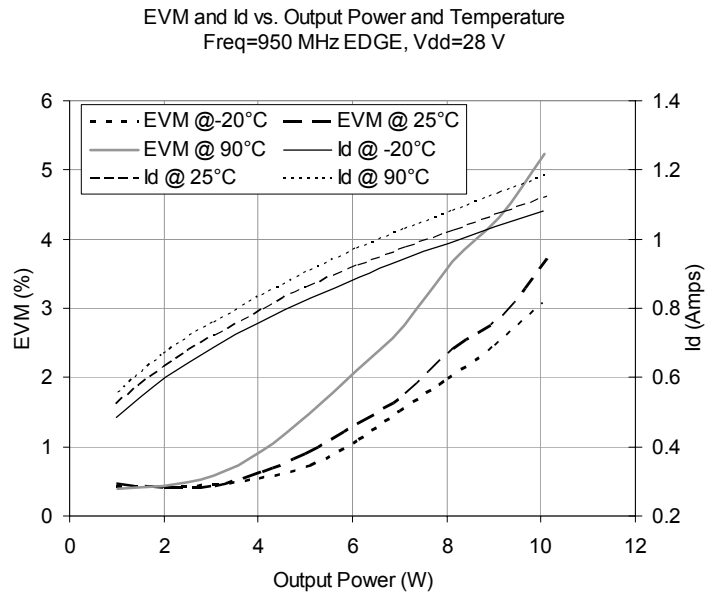
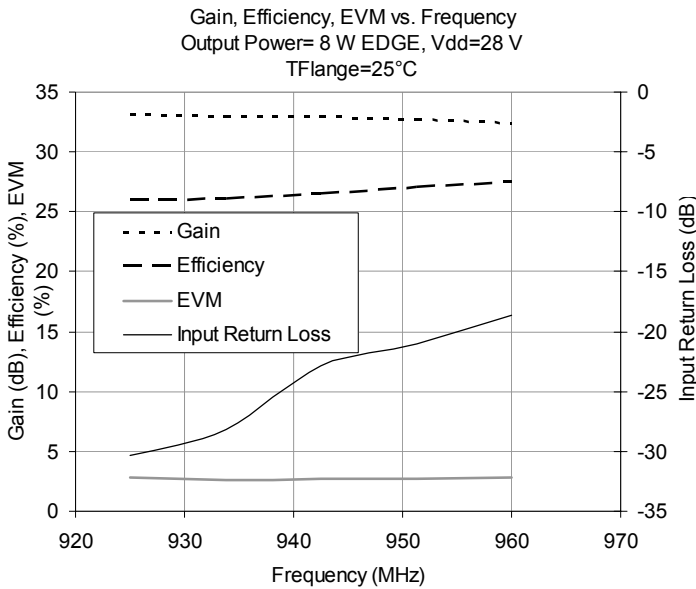
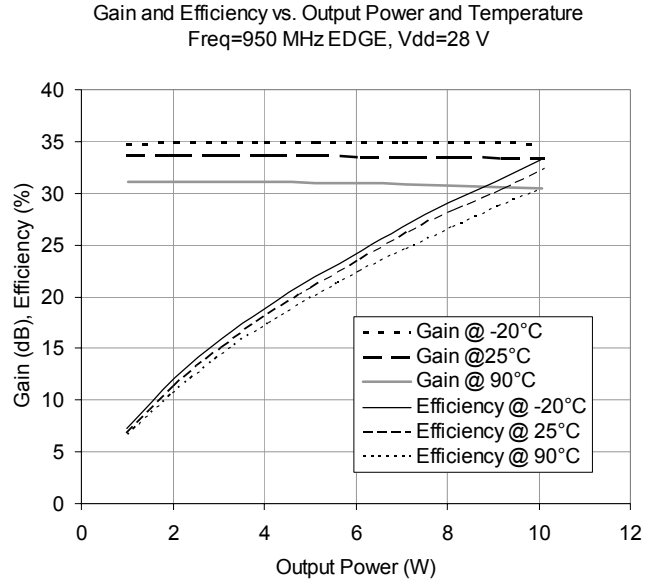
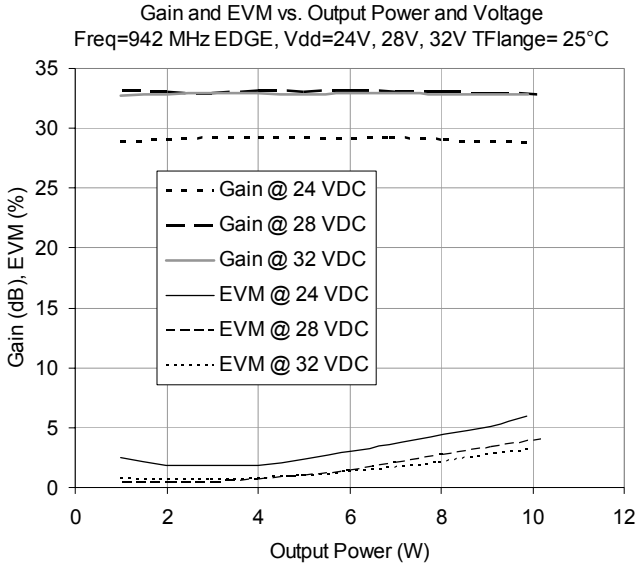



**XD010-14S-D4F 925-960 MHz 15W Power Amp Module**

**Test Board Schematic with module connections shown**

**Test Board Bill of Materials**

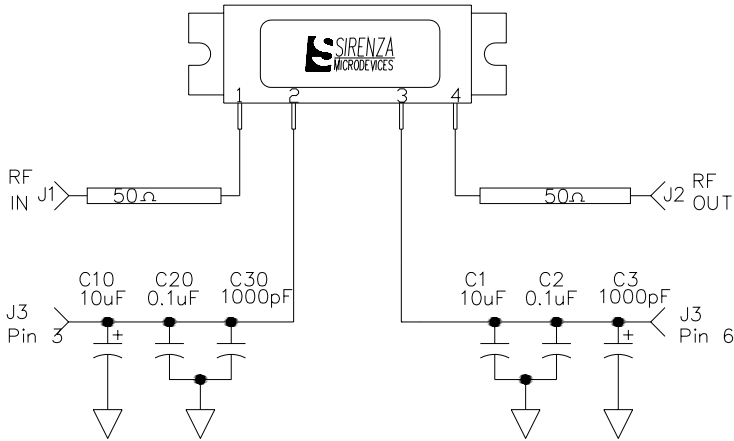

Component	Description	Manufacturer
PCB	Rogers 4350, $\epsilon_r=3.5$ Thickness=30mils	Rogers
J1, J2	SMA, RF, Panel Mount Tab W / Flange	Johnson
J3	MTA Post Header, 6 Pin, Rectangle, Polarized, Surface Mount	AMP
C1, C10	Cap, 10μF, 35V, 10%, Tant, Elect, D	Kemet
C2, C20	Cap, 0.1μF, 100V, 10%, 1206	Johanson
C3, C30	Cap, 1000pF, 100V, 10%, 1206	Johanson
C25, C26	Cap, 68pF, 250V, 5%, 0603	ATC
C21, C22	Cap, 0.1μF, 100V, 10%, 0805	Panasonic
C23, C24	Cap, 1000pF, 100V, 10%, 0603	AVX
Mounting Screws	4-40 X 0.250"	Various

**Test Board Layout**

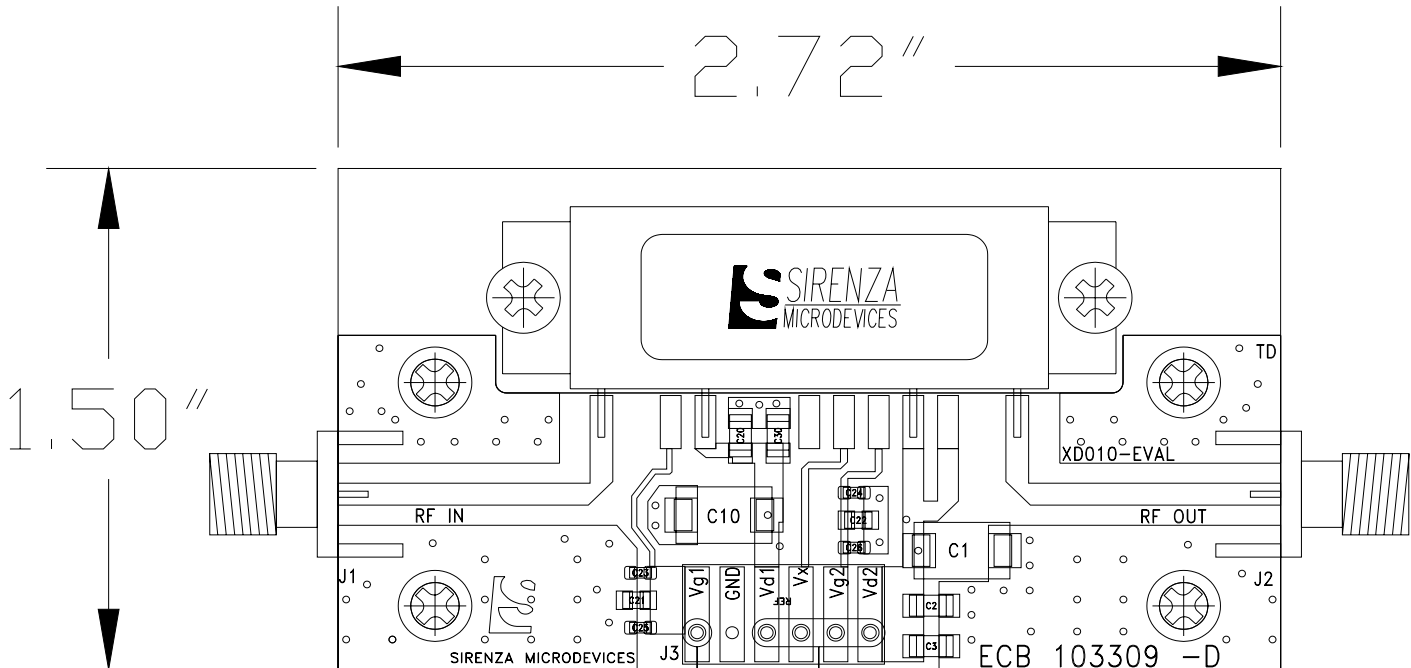

To receive Gerber files, DXF drawings, a detailed BOM, and assembly recommendations for the test board with fixture, contact applications support at [support@sirenza.com](mailto:support@sirenza.com). Data sheet for evaluation circuit (XD010-EVAL) available from Sirenza website.

303 S. Technology Court  
Broomfield, CO 80021

Phone: (800) SMI-MMIC  
4

<http://www.sirenza.com>  
EDS-102936 Rev E



**XD010-14S-D4F 925-960 MHz 15W Power Amp Module**

**Package Outline Drawing**

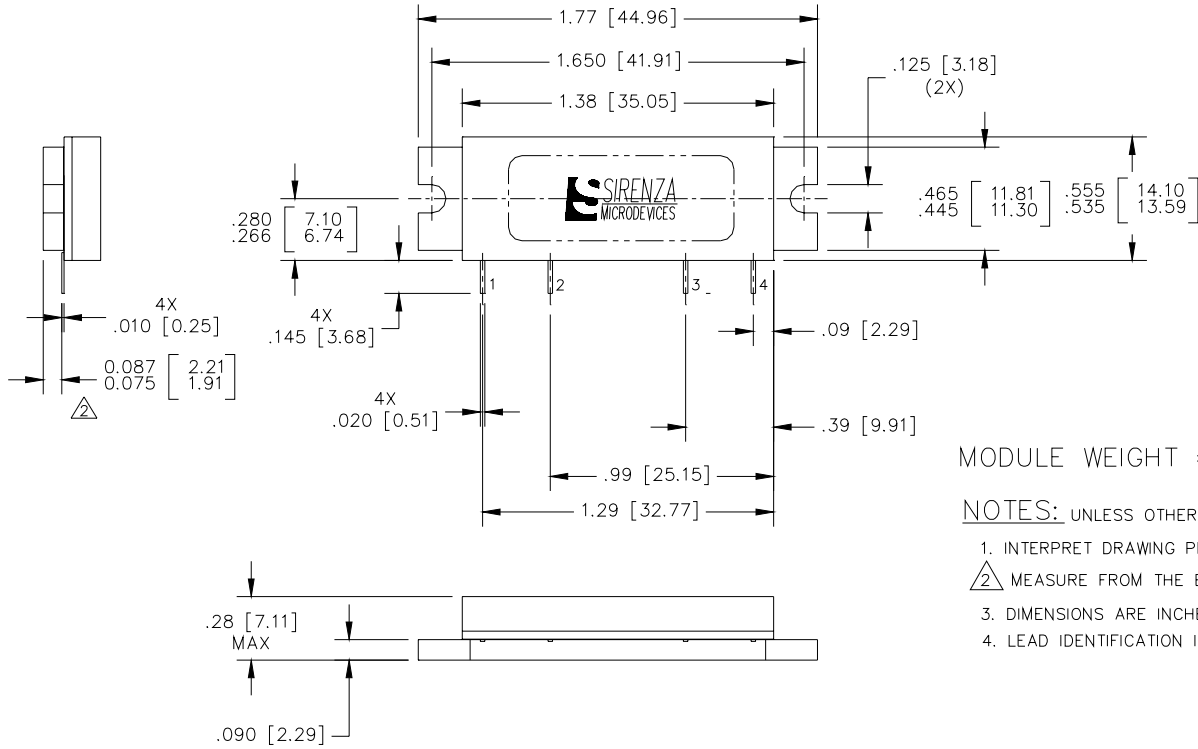

MODULE WEIGHT = 12gm Nominal

**NOTES:** UNLESS OTHERWISE SPECIFIED

1. INTERPRET DRAWING PER ANSI Y14.5.
2. MEASURE FROM THE BOTTOM OF THE LEADS.
3. DIMENSIONS ARE INCHES [MM].
4. LEAD IDENTIFICATION IS FOR REFERENCE ONLY.

**Recommended PCB Cutout and Landing Pads for the D4F Package**

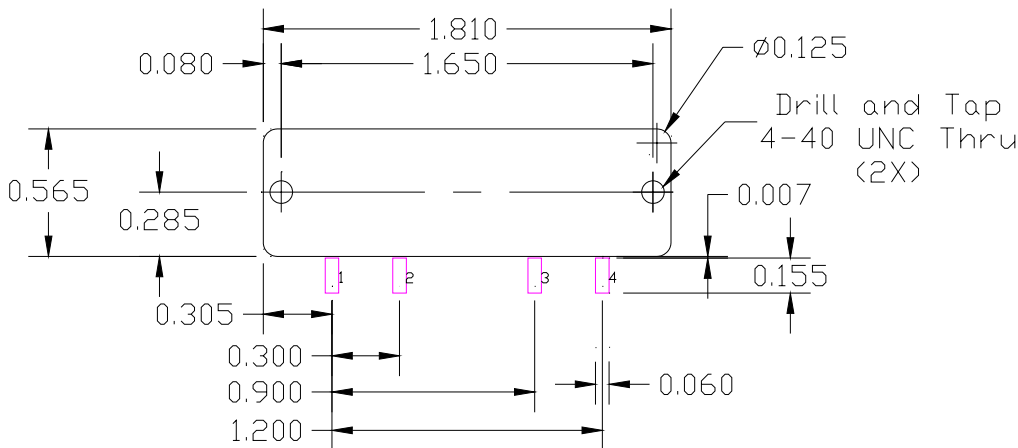

**Note 3:** Dimensions are in inches

Refer to Application note AN-060 "Installation Instructions for XD Module Series" for additional mounting info. App note available at [www.sirenza.com](http://www.sirenza.com)

SUNSTAR 商斯达实业集团是集研发、生产、工程、销售、代理经销、技术咨询、信息服务等为一体的高科技企业，是专业高科技电子产品生产厂家，是具有 10 多年历史的专业电子元器件供应商，是中国最早和最大的仓储式连锁规模经营大型综合电子零部件代理分销商之一，是一家专业代理和分销世界各大品牌 IC 芯片和电子元器件的连锁经营综合性国际公司，专业经营进口、国产名厂名牌电子元件，型号、种类齐全。在香港、北京、深圳、上海、西安、成都等全国主要电子市场设有直属分公司和产品展示展销窗口门市部专卖店及代理分销商，已在全国范围内建成强大统一的供货和代理分销网络。我们专业代理经销、开发生产电子元器件、集成电路、传感器、微波光电元器件、工控机/DOC/DOM 电子盘、专用电路、单片机开发、MCU/DSP/ARM/FPGA 软件硬件、二极管、三极管、模块等，是您可靠的一站式现货配套供应商、方案提供商、部件功能模块开发配套商。商斯达实业公司拥有庞大的资料库，有数位毕业于著名高校——有中国电子工业摇篮之称的西安电子科技大学（西军电）并长期从事国防尖端科技研究的高级工程师为您精挑细选、量身订做各种高科技电子元器件，并解决各种技术问题。

微波光电部专业代理经销高频、微波、光纤、光电元器件、组件、部件、模块、整机；电磁兼容元器件、材料、设备；微波 CAD、EDA 软件、开发测试仿真工具；微波、光纤仪器仪表。欢迎国外高科技微波、光纤厂商将优秀产品介绍到中国、共同开拓市场。长期大量现货专业批发高频、微波、卫星、光纤、电视、CATV 器件：晶振、VCO、连接器、PIN 开关、变容二极管、开关二极管、低噪晶体管、功率电阻及电容、放大器、功率管、MMIC、混频器、耦合器、功分器、振荡器、合成器、衰减器、滤波器、隔离器、环行器、移相器、调制解调器；光电子器件和组件：红外发射管、红外接收管、光电开关、光敏管、发光二极管和发光二极管组件、半导体激光二极管和激光器组件、光电探测器和光接收组件、光发射接收模块、光纤激光器和光放大器、光调制器、光开关、DWDM 用光发射和接收器件、用户接入系统光收发器件与模块、光纤连接器、光纤跳线/尾纤、光衰减器、光纤适配器、光隔离器、光耦合器、光环行器、光复用器/转换器；无线收发芯片和模组、蓝牙芯片和模组。

更多产品请看本公司产品专用销售网站：

商斯达中国传感器科技信息网：<http://www.sensor-ic.com/>

商斯达工控安防网：<http://www.pc-ps.net/>

商斯达电子元器件网：<http://www.sunstare.com/>

商斯达微波光电产品网：[HTTP://www.rfoe.net/](http://www.rfoe.net/)

商斯达消费电子产品网：<http://www.icasic.com/>

商斯达实业科技产品网：<http://www.sunstars.cn/> 微波元器件销售热线：

地址：深圳市福田区福华路福庆街鸿图大厦 1602 室

电话：0755-82884100 83397033 83396822 83398585

传真：0755-83376182 (0) 13823648918 MSN: SUNS8888@hotmail.com

邮编：518033 E-mail:szss20@163.com QQ: 195847376

深圳赛格展销部：深圳华强北路赛格电子市场 2583 号 电话：0755-83665529 25059422

技术支持：0755-83394033 13501568376

欢迎索取免费详细资料、设计指南和光盘；产品凡多，未能尽录，欢迎来电查询。

北京分公司：北京海淀区知春路 132 号中发电子大厦 3097 号

TEL: 010-81159046 82615020 13501189838 FAX: 010-62543996

上海分公司：上海市北京东路 668 号上海赛格电子市场 D125 号

TEL: 021-28311762 56703037 13701955389 FAX: 021-56703037

西安分公司：西安高新开发区 20 所(中国电子科技集团导航技术研究所)

西安劳动南路 88 号电子商城二楼 D23 号

TEL: 029-81022619 13072977981 FAX:029-88789382