

## Plastic Tube Container Dimensions

DIP, SDIP, SIP, ZIP, DMP, SDMP, TO, SOP, EMP, SOT, PLCC packages are packed in the plastic tube container. The dimensions are mentioned as follows.

### 1. Plastic Tube Container for dual-in-line plastic mold

#### (1) Plastic Tube Container dimensions for DIP8

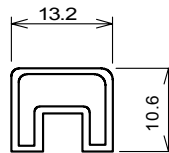
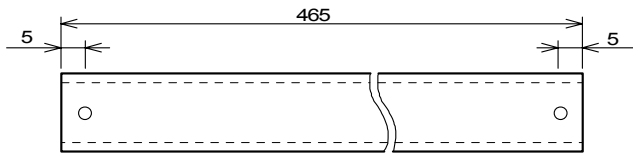

- 1. Material PVC
- 2. Stopper Stick Pin
- 3. Contents DIP8 50pcs/tube

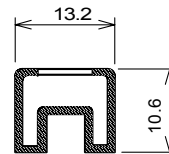
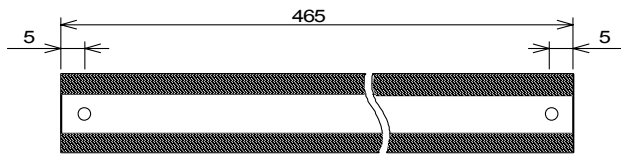

- 1. Material PS Carbon
- 2. Stopper Stick Pin
- 3. Contents DIP8 50pcs/tube

UNIT: mm

#### (2) Plastic Tube Container dimensions for DIP14/16

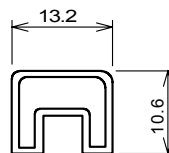
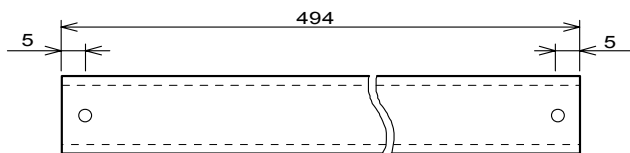

- 1. Material PVC
- 2. Stopper Stick Pin
- 3. Contents DIP14 25pcs/tube  
DIP16 25pcs/tube

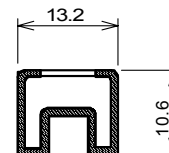
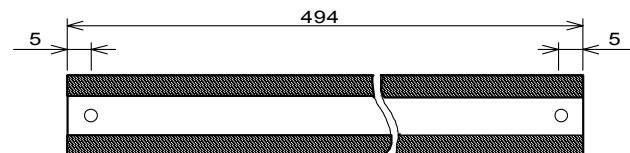

- 1. Material PS Carbon
- 2. Stopper Stick Pin
- 3. Contents DIP14 25pcs/tube  
DIP16 25pcs/tube

UNIT: mm

# PLASTIC TUBE DIMENSIONS

## (3) Plastic Tube Container dimensions for DIP14-D1

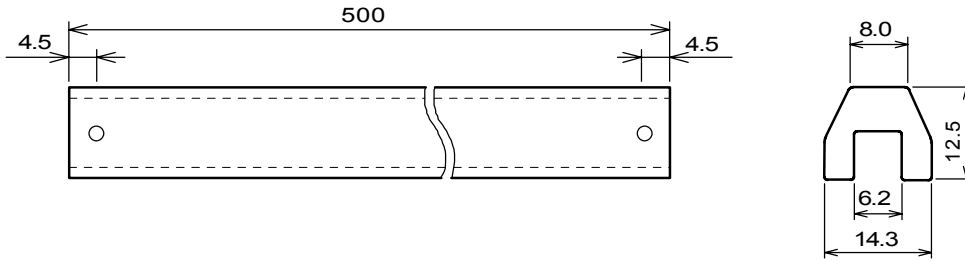

- |             |                     |
|-------------|---------------------|
| 1. Material | PVC                 |
| 2. Stopper  | Stick Pin           |
| 3. Contents | DIP14-D1 25pcs/tube |

UNIT: mm

## (4) Plastic Tube Container dimensions for DIP16-D2/D3

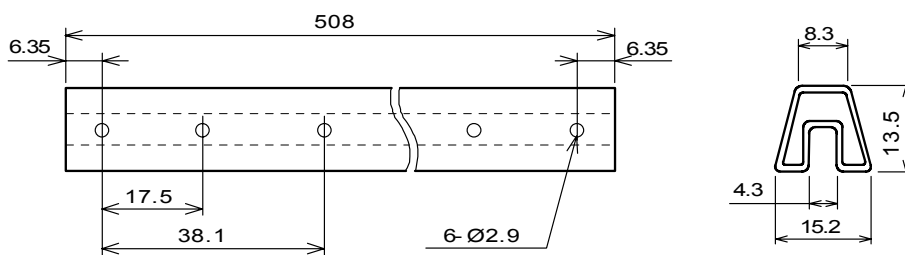

- |              |                        |
|--------------|------------------------|
| 1. Thickness | 0.5mm                  |
| 2. Material  | PVC                    |
| 3. Stopper   | Stick Pin              |
| 4. Contents  | DIP16-D2/D3 25pcs/tube |

UNIT: mm

# PLASTIC TUBE DIMENSIONS

## (5) Plastic Tube Container dimensions for DIP18/20

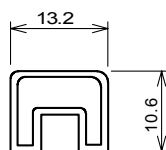
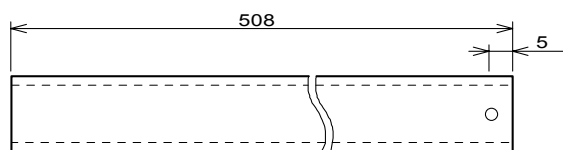

- 1. Material PVC
- 2. Stopper Stick Pin
- 3. Contents DIP18 20pcs/tube  
DIP20 20pcs/tube

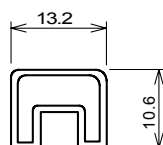
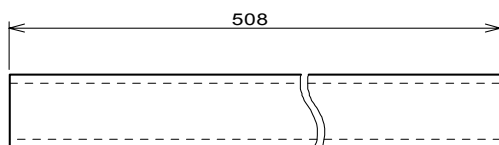

- 1. Material PVC
- 2. Stopper Rubber Knob
- 3. Contents DIP18 20pcs/tube  
DIP20 20pcs/tube

UNIT: mm

## (6) Plastic Tube Container dimensions for DIP22

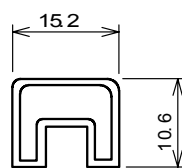
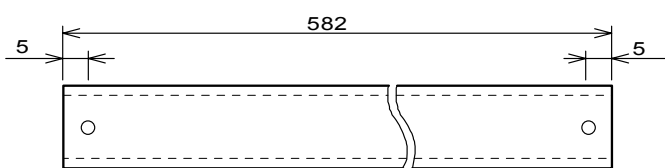

- 1. Material PVC
- 2. Stopper Stick pin
- 3. Contents DIP22 20pcs/tube

UNIT: mm

# PLASTIC TUBE DIMENSIONS

## (7) Plastic Tube Container dimensions for DIP22-D2

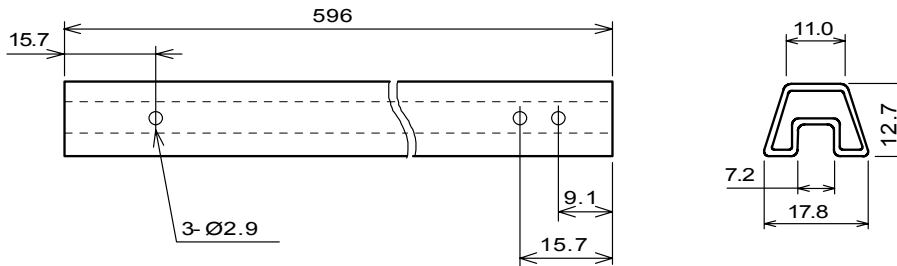

- |             |                     |
|-------------|---------------------|
| 1.Thickness | 0.5mm               |
| 2.Material  | PVC                 |
| 3.Stopper   | Stick Pin           |
| 4.Contents  | DIP22-D2 20pcs/tube |

UNIT: mm

## (8) Plastic Tube Container dimensions for DIP24-D2

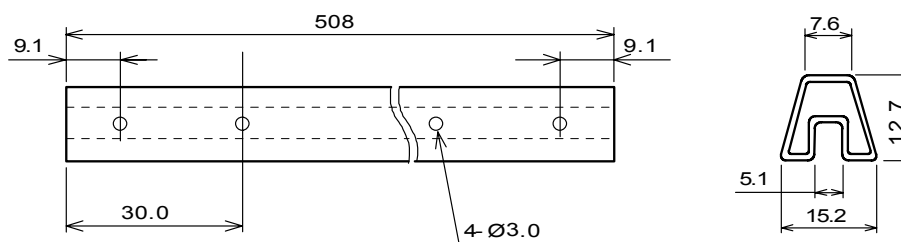

- |             |                     |
|-------------|---------------------|
| 1.Thickness | 0.5mm               |
| 2.Material  | PVC                 |
| 3.Stopper   | Stick pin           |
| 4.Contents  | DIP24-D2 16pcs/tube |

UNIT: mm

# PLASTIC TUBE DIMENSIONS

## (8) Plastic Tube Container dimensions for DIP32

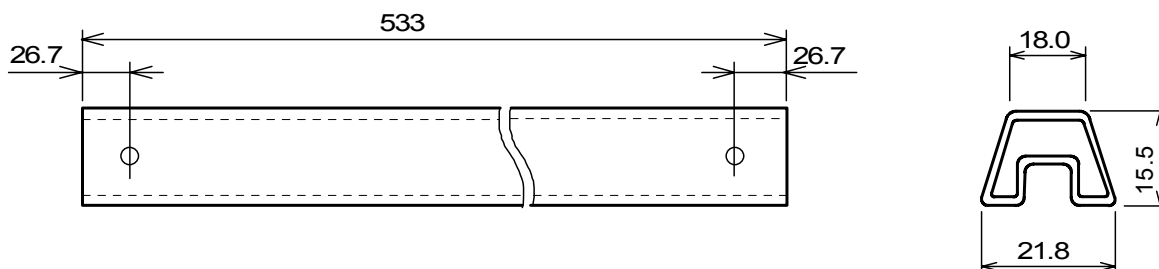

- 1. Material      PVC
- 2. Stopper      Stick pin
- 3. Contents     DIP32  11pcs/tube

UNIT: mm

## (9) Plastic Tube Container dimensions for DIP40

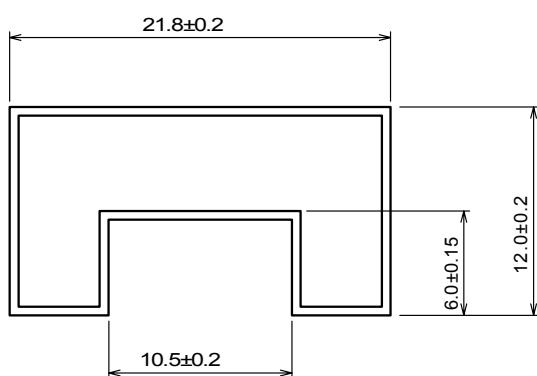

- 1. Length        550mm
- 2. Thickness    0.5mm
- 3. Material      PVC
- 4. Stopper       Rubber Knob
- 5. Contents     DIP40  10pcs/tube

UNIT: mm

# PLASTIC TUBE DIMENSIONS

## 2. Plastic Tube Container for shrunk dual-line plastic mold

### (1) Plastic Tube Container dimensions for SDIP22

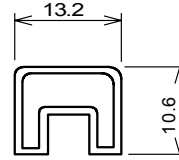
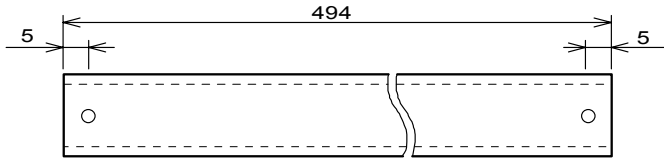

- 1. Material PVC
- 2. Stopper Stick pin
- 3. Contents SDIP22 25pcs/tube

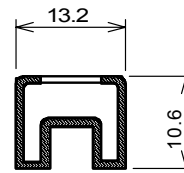
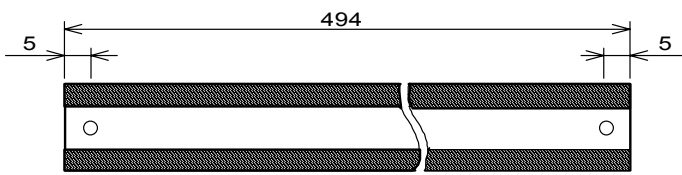

- 1. Material PS Carbon
- 2. Stopper Stick pin
- 3. Contents SDIP22 25pcs/tube

UNIT: mm

### (2) Plastic Tube Container dimensions for SDIP24

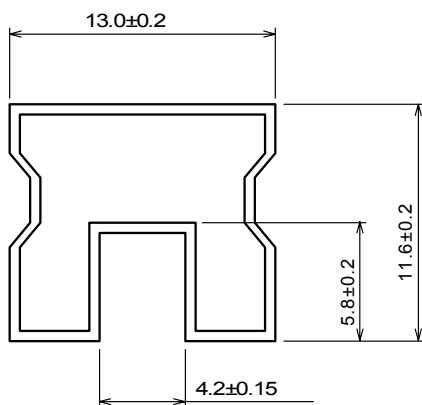

- 1. Length 505mm
- 2. Thickness 0.5mm
- 3. Material PVC
- 4. Stopper Rubber Knob
- 5. Contents SDIP24 20pcs/tube

UNIT: mm

# PLASTIC TUBE DIMENSIONS

---

## (3) Plastic Tube Container dimensions for SDIP28

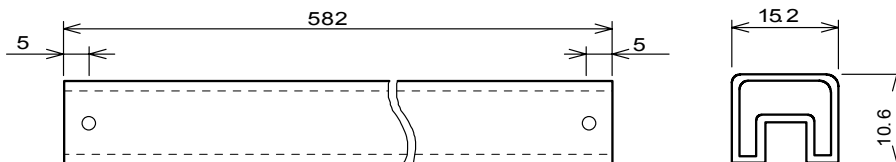

- |            |                   |
|------------|-------------------|
| 1.Material | PVC               |
| 2.Stopper  | Stick Pin         |
| 3.Contents | SDIP28 20pcs/tube |

UNIT: mm

---

## (4) Plastic Tube Container dimensions for SDIP30/32

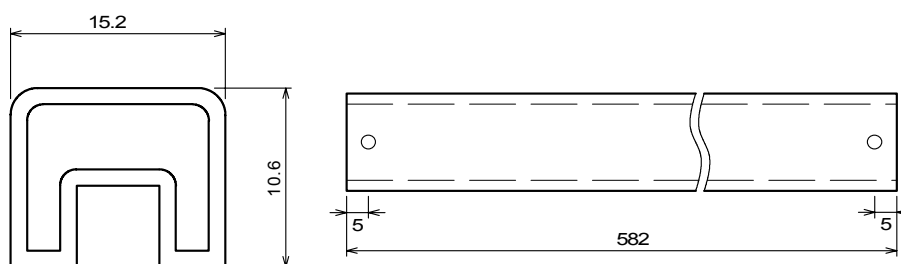

- |            |  |
|------------|--|
| 1.Material | PVC                                    |
| 2.Stopper  | Stick Pin                              |
| 3.Contents | SDIP30 20pcs/tube<br>SDIP32 20pcs/tube |

UNIT: mm

---

## (5) Plastic Tube Container dimensions for SDIP42

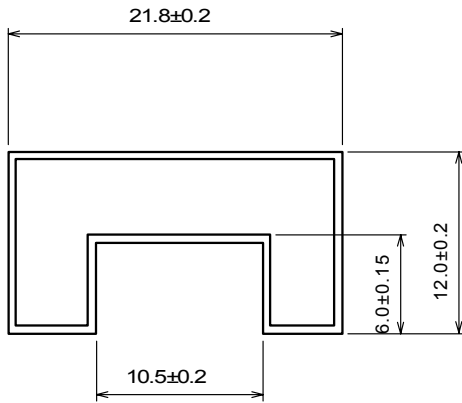

- 1.Length 550mm
- 2.Thickness 0.5mm
- 3.Material PVC
- 4.Stopper Rubber knob
- 5.Contents SDIP42 14pcs/tube

UNIT: mm

## (6) Plastic Tube Container dimensions for SDIP56

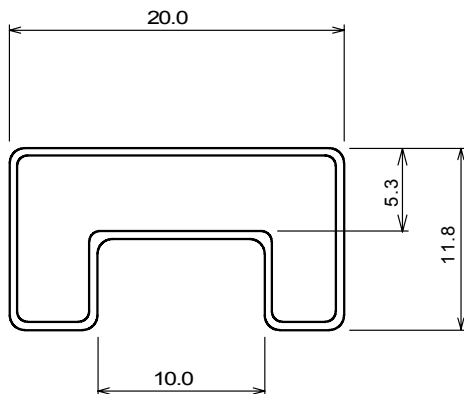

- 1.Length 558mm
- 2.Thickness 0.5mm
- 3.Material PVC
- 4.Stopper Rubber knob
- 5.Contents SDIP56 10pcs/tube

UNIT: mm



# PLASTIC TUBE DIMENSIONS

---

## 3. Plastic Tube Container for single-in-line plastic mold

### (1) Plastic Tube Container dimensions for SIP8

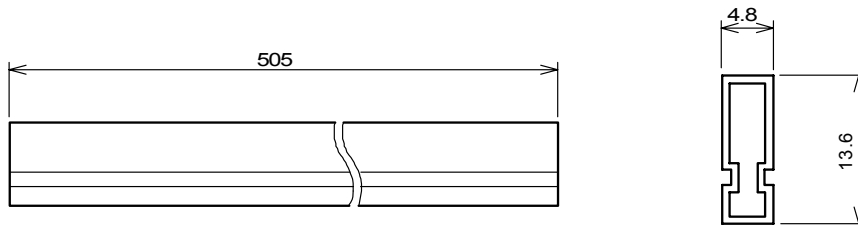

- |             |                 |
|-------------|-----------------|
| 1.Thickness | 0.5 mm          |
| 2.Material  | PVC             |
| 3.Stopper   | Rubber Knob     |
| 4.Contents  | SIP8 25pcs/tube |

UNIT: mm

---

UNIT: mm

## (3) Plastic Tube Container dimensions for ZIP16

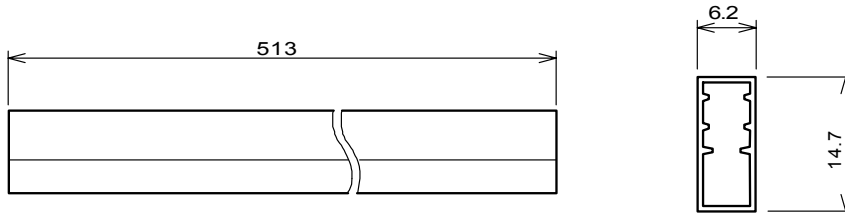

- |            |                  |
|------------|------------------|
| 1.Material | PVC              |
| 2.Stopper  | Rubber Knob      |
| 3.Contents | ZIP16 20pcs/tube |

UNIT: mm

## 4.Plastic Tube Container for dual-in-line plastic mini mold

### (1) Plastic Tube Container dimensions for DMP8/14/16/20

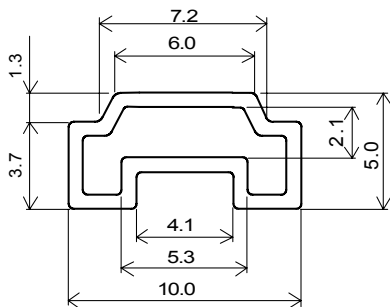

- |             |  |
|-------------|--|
| 1.Length    | 515 ± 2mm                                  |
| 2.Thickness | 0.6mm                                      |
| 3.Material  | PVC  |
| 4.Stopper   | Rubber Knob                                |
| 5.Contents  | DMP8 100pcs/tube<br>DMP14/16/20 50pcs/tube |

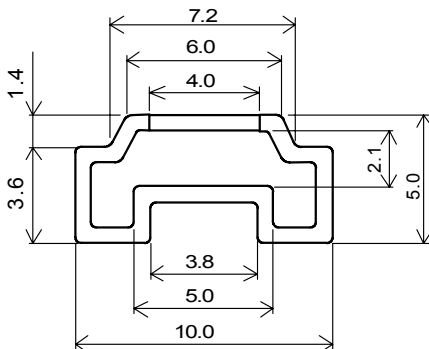

- |             |  |
|-------------|--|
| 1.Length    | 515 ± 2mm                                  |
| 2.Thickness | 0.6mm                                      |
| 3.Material  | PS Carbon                                  |
| 4.Stopper   | Rubber Knob                                |
| 5.Contents  | DMP8 100pcs/tube<br>DMP14/16/20 50pcs/tube |

UNIT: mm

# PLASTIC TUBE DIMENSIONS

## (2) Plastic Tube Container dimensions for DMP24/SDMP30

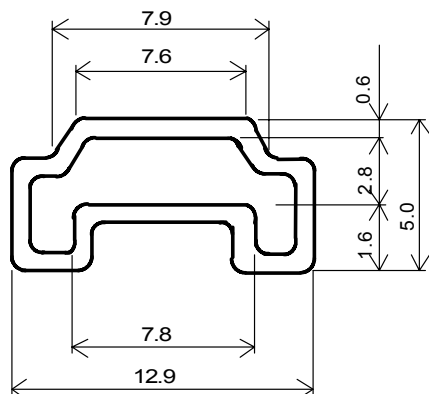

- 1.Length 410 ± 2mm
- 2.Thickness 0.6mm
- 3.Material PVC
- 4.Stopper Rubber Knob
- 5.Contents
 

DMP24	25pcs/tube
SDMP30	25pcs/tube

UNIT: mm

## (3) Plastic Tube Container dimensions for SOP8

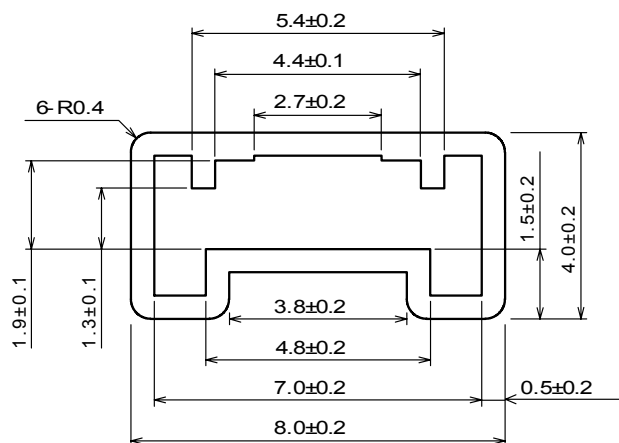

- 1.Length 280.5mm
- 2.Material PVC
- 3.Stopper Rubber Knob
- 4.Contents SOP8 50pcs/tube

UNIT: mm



# PLASTIC TUBE DIMENSIONS

---

(6) Plastic Tube Container dimensions for SOP22

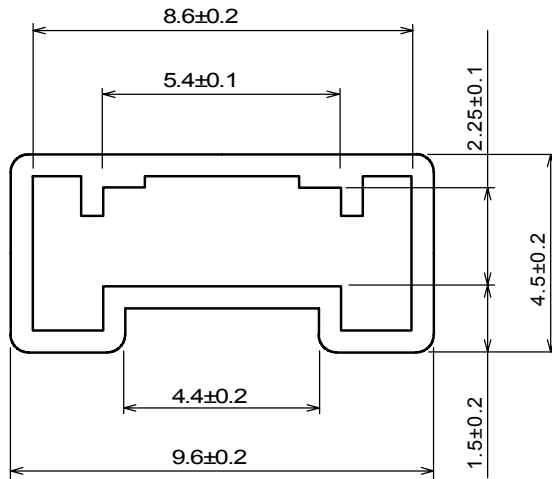

- |             |                  |
|-------------|------------------|
| 1.Length    | 400mm            |
| 2.Thickness | 0.5mm            |
| 3.Material  | PVC              |
| 4.Stopper   | Rubber Knob      |
| 5.Contents  | SOP22 25pcs/tube |

UNIT: mm

---

UNIT: mm

# PLASTIC TUBE DIMENSIONS

## (7) Plastic Tube Container dimensions for SOP28

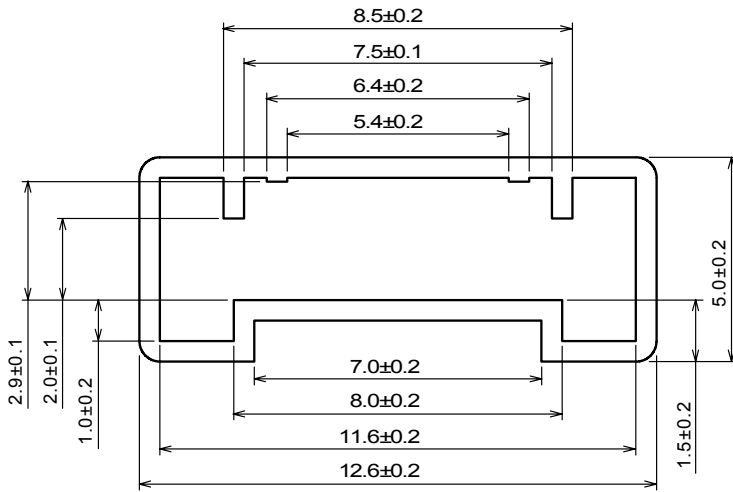

- 1.Length 400mm
- 2.Thickness 0.5mm
- 3.Material PVC
- 4.Stopper Rubber Knob
- 5.Contents SOP28 20pcs/tube

UNIT: mm

## (8) Plastic Tube Container dimensions for SOP40

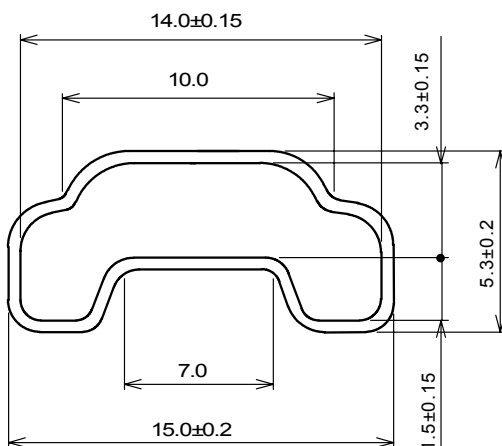

- 1.Length 430mm
- 2.Material PVC
- 3.Stopper Rubber Knob
- 4.Contents SOP40 15pcs/tube

UNIT: mm

# PLASTIC TUBE DIMENSIONS

---

## (9) Plastic Tube Container dimensions for EMP8/14

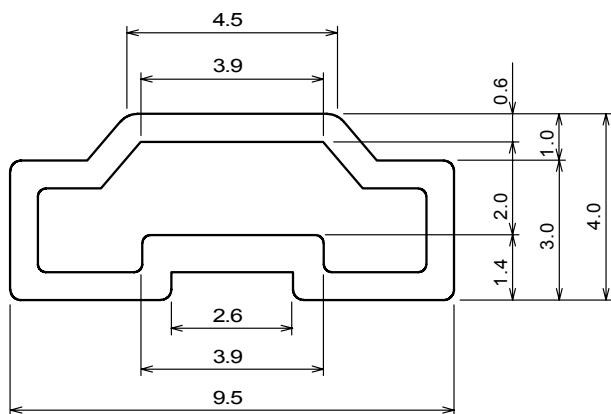

- |            |             |             |
|------------|-------------|-------------|
| 1.Length   | EMP8        | 508mm       |
|            | EMP14       | 451mm       |
| 2.Material | PVC         |             |
| 3.Stopper  | Rubber Knob |             |
| 4.Contents | EMP8        | 100pcs/tube |
|            | EMP14       | 50pcs/tube  |

UNIT: mm

---

## (10) Plastic Tube Container dimensions for EMP16-E2/20-E2/24-E3

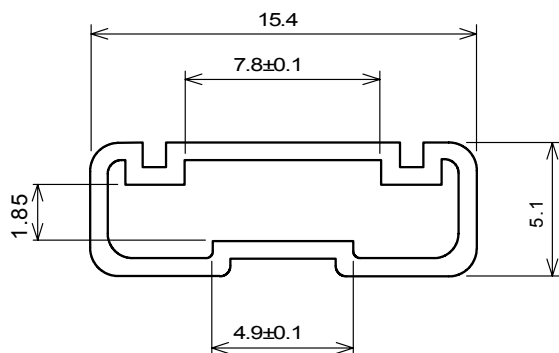

- |             |                |            |
|-------------|----------------|------------|
| 1.Length    | EMP16-E2/20-E2 | 540mm      |
|             | EMP24-E3       | 410mm      |
| 2.Thickness | 0.7mm          |            |
| 3.Material  | PVC            |            |
| 4.Stopper   | Stick Pin      |            |
| 5.Contents  | EMP16-E2       | 50pcs/tube |
|             | EMP20-E2       | 40pcs/tube |
|             | EMP24-E3       | 25pcs/tube |

UNIT: mm

## 5. Plastic Tube Container for Transistor outline

### (1) Plastic Tube Container dimensions for TO-220(5pin)Straight Type

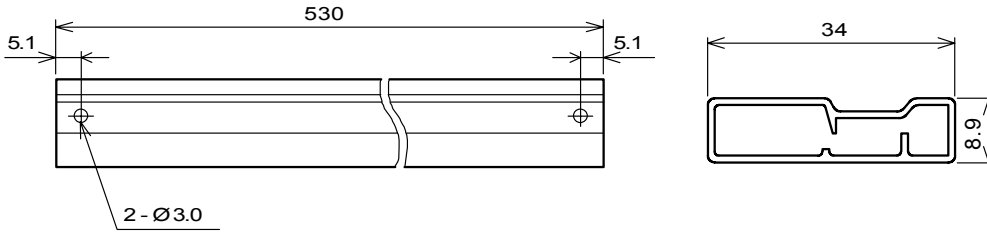

- 1. Material    PVC
- 2. Stopper    Stick Pin
- 3. Contents    TO-220-5(Straight Type) 50pcs/tube

UNIT: mm

### (2) Plastic Tube Container dimensions for TO-220(5pin)Forming Type

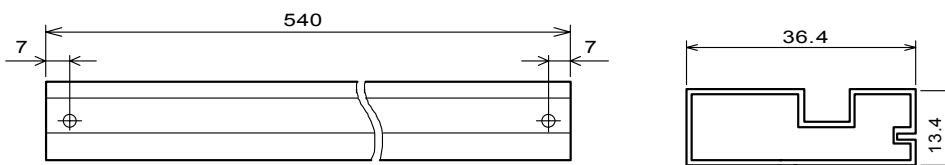

- 1. Material    PVC
- 2. Stopper    Stick Pin
- 3. Contents    TO-220-5(Forming Type) 50pcs/tube

UNIT: mm



# PLASTIC TUBE DIMENSIONS

---

## (3) Plastic Tube Container dimensions for TO-220F(4pin)Straight Type

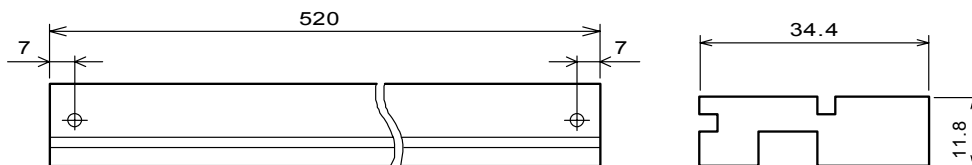

- 1. Material PVC
- 2. Stopper Stick Pin
- 3. Contents TO-220F-4(Straight Type) 50pcs/tube

UNIT: mm

---

## (4) Plastic Tube Container dimensions for TO-220F(4pin)Forming Type



- 1. Material PVC
- 2. Stopper Stick Pin
- 3. Contents TO-220F-4(Forming Type) 50pcs/tube

UNIT: mm

---

## 6. Plastic Tube Container for Small outline transistor

### (1) Plastic Tube Container dimensions for SOT89

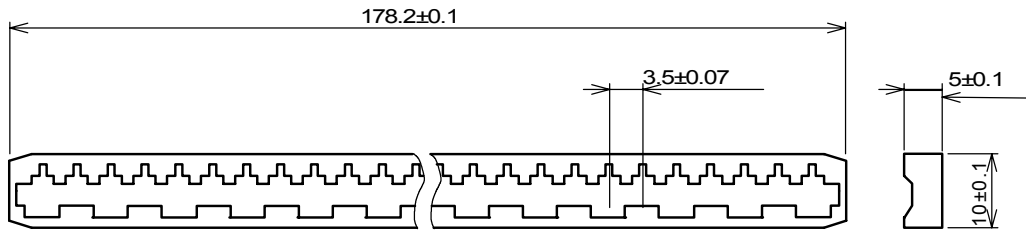

- 1. Material    PVC
- 2. Contents   SOT89   25pcs/tube

UNIT: mm

## 7. Plastic Tube Container for Plastic leadless chip carrier

### (1) Plastic Tube Container dimensions for PLCC28-M2

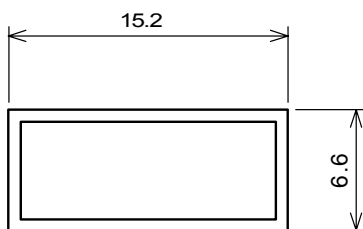

- 1. Length      532mm
- 2. Thickness   0.76mm
- 3. Material    PVC
- 4. Stopper     Rubber Knob
- 5. Contents    PLCC28-M2   40pcs/tube

UNIT: mm