

SINGLE-SUPPLY DUAL OPERATIONAL AMPLIFIER

■ GENERAL DESCRIPTION

The NJM2143 is a single-supply operational amplifier in VSP8. Its input stage of Darlington PNP detects GND level.

There is no crossover distortion in single supply operation when the load is direct-coupled to ground.

■ PACKAGE OUTLINE



NJM2143R

NJM2143RB1

■ FEATURES

- Single-Supply Operation
- Operating Voltage (+3~+20V)
- Low Operating Current (0.7mA typ.)
- Bipolar Technology
- Package Outline VSP8,TVSP8

■ PIN CONFIGURATION

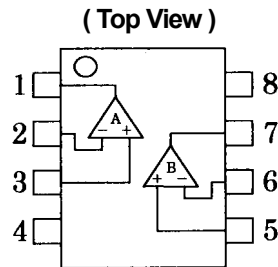

PIN FUNCTION

- 1.A OUTPUT
- 2.A -INPUT
- 3.A +INPUT
- 4.GND
- 5.B +INPUT
- 6.B -INPUT
- 7.B OUTPUT
- 8.V⁺

■ EQUIVALENT CIRCUIT (1/2 Shown)

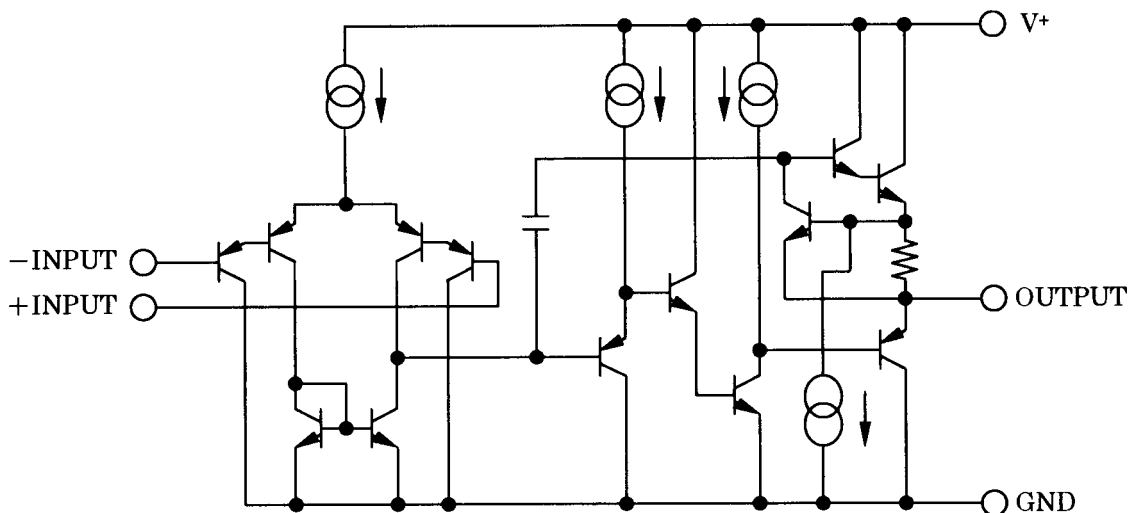

NJM2143

■ ABSOLUTE MAXIMUM RATINGS

(Ta=25°C)

PARAMETER	SYMBOL	RATINGS	UNIT
Supply Voltage	$V^+(V^+V^-)$	20 (± 10)	V
Differential Input Voltage	V_{ID}	20	V
Input Voltage	V_{IC}	-0.3~+20 (note1)	V
Power Dissipation	P_D	320	mW
Operating Temperature Range	T_{opr}	-40~+85	°C
Storage Temperature Range	T_{stg}	-50~+125	°C

(note1) When input voltage is less than +20V, the absolute maximum control voltage is equal to the input voltage.

■ ELECTRICAL CHARACTERISTICS

($V^+=5.0V, Ta=25°C$)

PARAMETER	SYMBOL	TEST CONDITION	MIN.	TYP.	MAX.	UNIT
Input Offset Voltage	V_{IO}	$R_S=0\Omega$	-	2	7	mV
Input Offset Current	I_{IO}		-	5	50	nA
Input Bias Current	I_B		-	25	250	nA
Large Signal Voltage Gain	A_V	$R_L \geq 2k\Omega$	-	100	-	dB
Maximum Output Voltage Swings	V_{OM1}	$R_L=2k\Omega$	3.5	-	-	V_{P-P}
Input Common Mode Voltage Range	V_{ICM}		0~3.5	-	-	V
Common Mode Rejection Ratio	CMRR		-	85	-	dB
Supply Voltage Rejection Ratio	PSRR		-	100	-	dB
Output Source Current	I_{SOURCE}	$V_{IN}^+=1V, V_{IN}^-=0V$	20	30	-	mA
Output Sink Current	I_{SINK}	$V_{IN}^+=0V, V_{IN}^-=1V$	8	20	-	mA
Channel Separation	CS		-	120	-	dB
Operating Current	I_{CC}		-	0.7	1.2	mA
Slew Rate	SR		-	0.5	-	V/ μ s
Gain Bandwidth Product	GB		-	0.6	-	MHz

■ TYPICAL CHARACTERISTICS

Maximum Output Voltage Swing vs. Load Resistance
($V^+=5V$, $T_a=25^\circ C$)

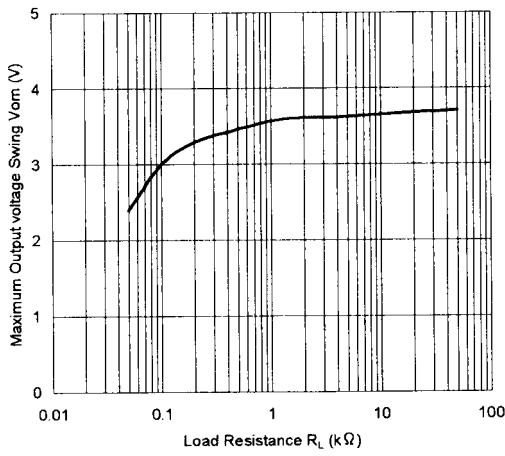

Voltage Gain vs. Frequency

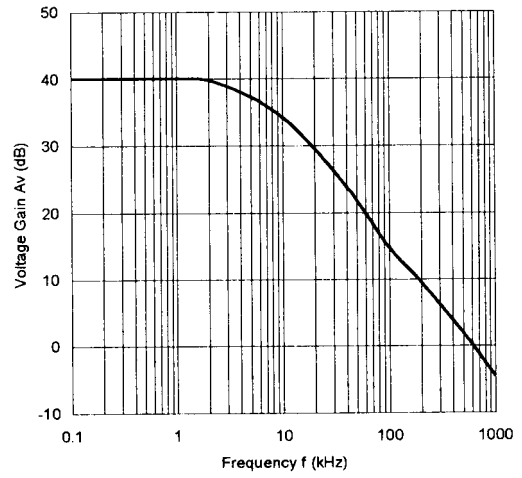

Operating Current vs. Operating Voltage
($T_a=25^\circ C$)

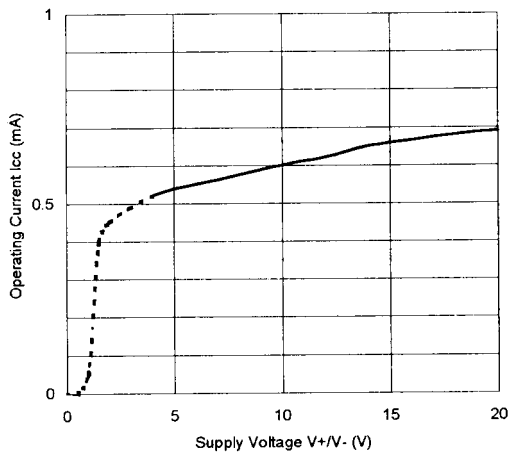

Voltage Gain vs. Operating Voltage

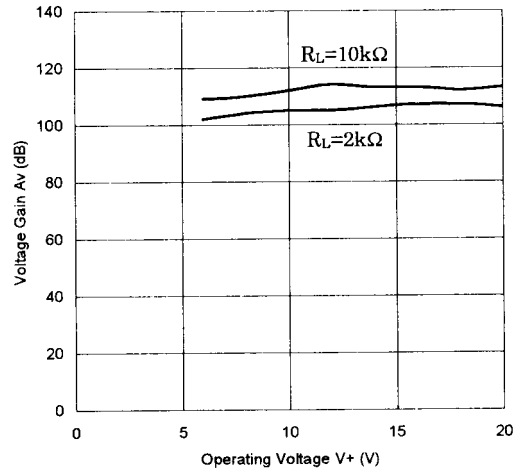

Maximum Output Voltage vs. Operating Voltage
($R_L=2k\Omega$, $T_a=25^\circ C$)

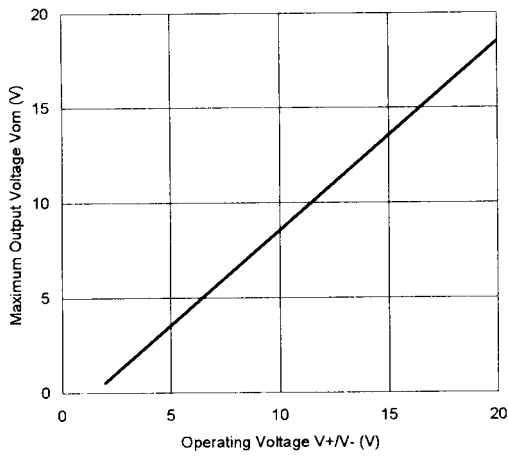

■ TYPICAL CHARACTERISTICS

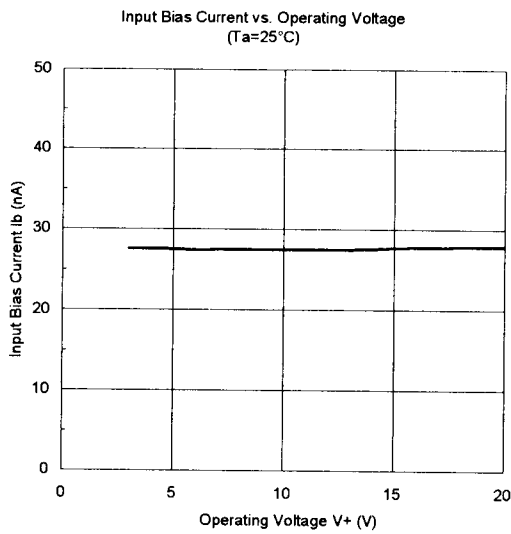
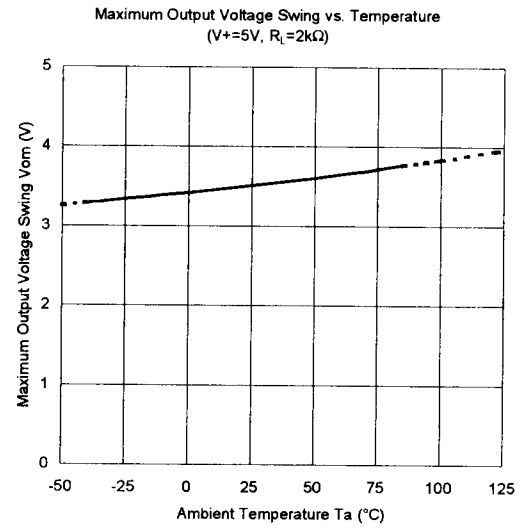
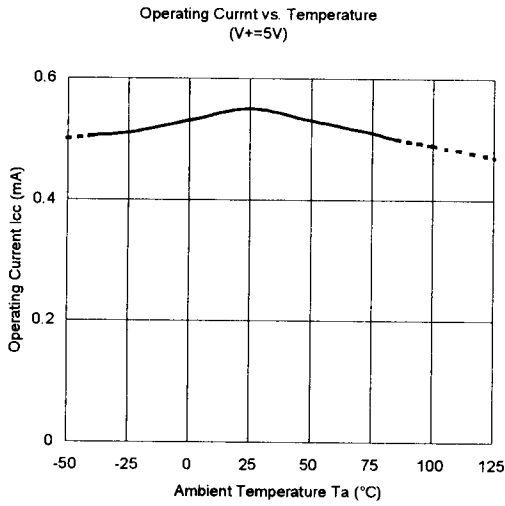
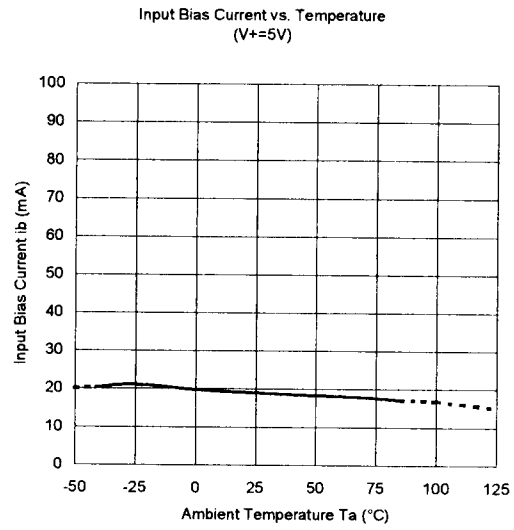
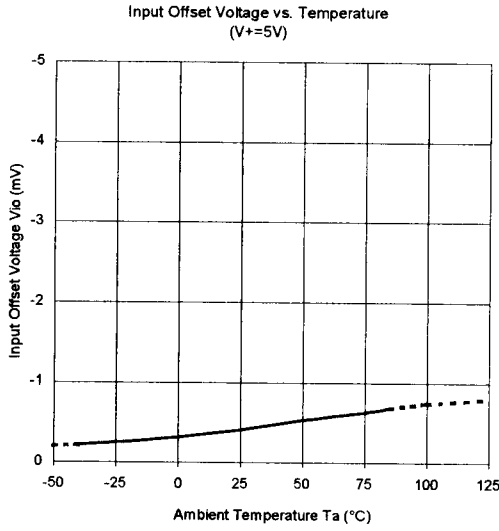

■ TYPICAL CHARACTERISTICS

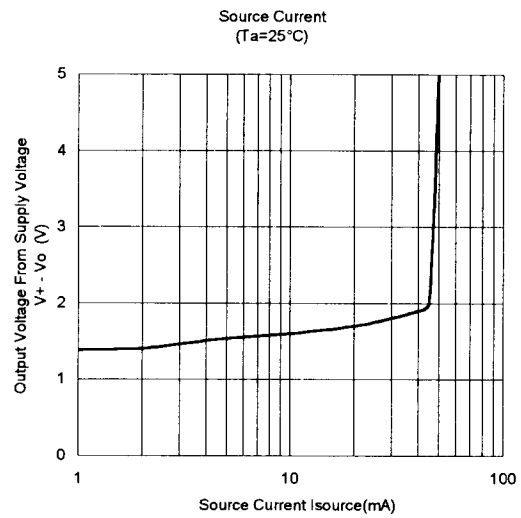
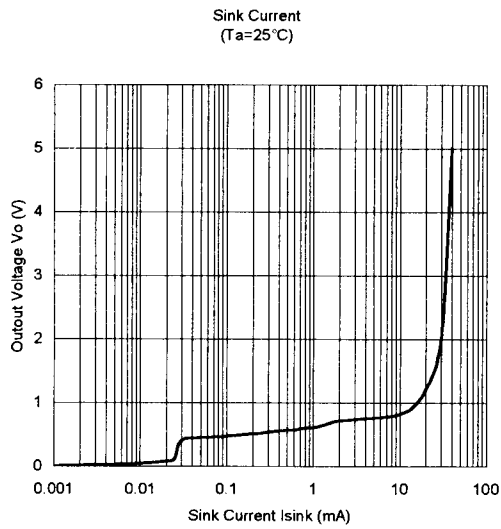

[CAUTION]

The specifications on this databook are only given for information, without any guarantee as regards either mistakes or omissions. The application circuits in this databook are described only to show representative usages of the product and not intended for the guarantee or permission of any right including the industrial rights.