

SINGLE SUPPLY QUAD OPERATIONAL AMPLIFIER

■ GENERAL DESCRIPTION

The NJM12902 is single-supply quad operational amplifier, which can operate from 2V supply. The features are low offset voltage, low bias current, and drive TTL or DTL circuit directly. The package lineup is DIP, DMP and others compact, so that the NJM12902 is suitable for audio for low voltage operation and any other kind of signal amplifier.

■ FEATURES

- Operating Voltage (+2V~+14V)
- Input Offset Voltage (5mV max.)
- Slew Rate (0.7V/μs typ.)
- Operating Current (1.0mA typ.)
- Bipolar Technology
- Package Outline DIP14,DMP14,EMP14,SSOP14

■ PACKAGE OUTLINE

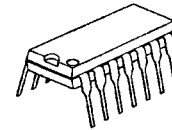

NJM12902D1

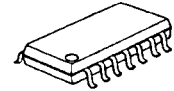

NJM12902M

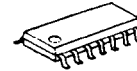

NJM12902E



NJM12902V

■ PIN CONFIGURATION

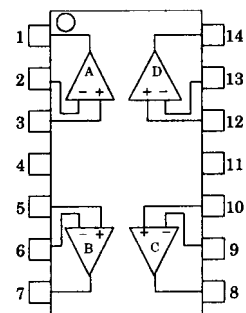

NJM12902D1/12902M
NJM12902E/12902V

PIN FUNCTION	
1.A OUTPUT	8.C OUTPUT
2.A -INPUT	9.C -INPUT
3.A +INPUT	10.C +INPUT
4.V ⁺	11.GND
5.B +INPUT	12.D +INPUT
6.B -INPUT	13.D -INPUT
7.B OUTPUT	14.D OUTPUT

■ EQUIVALENT CIRCUIT (1/4 Shown)

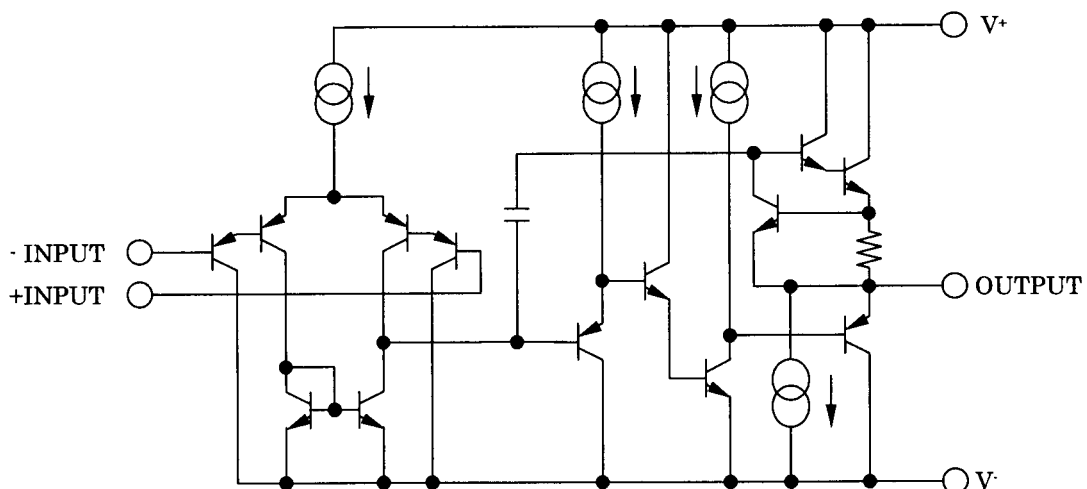

NJM12902

■ ABSOLUTE MAXIMUM RATINGS

(Ta=25°C)

PARAMETER	SYMBOL	RATINGS	UNIT
Supply Voltage	V ⁺	15	V
Differential Input Voltage	V _{ID}	14	V
Input Voltage	V _{IC}	-0.3~+14	V
Power Dissipation	P _D	(DIP14) 700 (DMP14) 300 (EMP14) 300 (SSOP14) 300	mW
Operating Temperature Range	T _{opr}	-40~+85	°C
Storage Temperature Range	T _{stg}	-50~+125	°C

■ ELECTRICAL CHARACTERISTICS

(V⁺=5V, Ta=25°C)

PARAMETER	SYMBOL	TEST CONDITION	MIN.	TYP.	MAX.	UNIT
Operating Voltage	V _{opr}		2	-	14	V
Input Offset Voltage	V _{IO}	R _S =0Ω	-	1	5	mV
Input Offset Current	I _{IO}		-	5	50	nA
Input Bias Current	I _B		-	20	150	nA
Large Signal Voltage Gain	A _V	R _L ≥2kΩ	-	100	-	dB
Maximum Output Voltage Swing	V _{OM}	R _L =2kΩ	3.5	-	-	V
Input Common Mode Voltage Range	V _{ICM}		0~3.5	-	-	V
Common Mode Rejection Ratio	CMR		-	85	-	dB
Supply Voltage Rejection Ratio	SVR		-	100	-	dB
Output Source Current	I _{SOURCE}	V _{IN} ⁺ =1V, V _{IN} ⁻ =0V	20	40	-	mA
Output Sink Current	I _{SINK}	V _{IN} ⁺ =0V, V _{IN} ⁻ =1V	8	30	-	mA
Channel Separation	CS	f=1k~20kHz	-	120	-	dB
Operating Current	I _{CC}	R _L =∞	-	1.0	2.0	mA
Slew Rate	SR	V ⁺ /V=±2.5V, R _L =2kΩ, A _V =0dB, f=1kHz	-	0.7	-	V/μs
Gain Bandwidth Product	GB		-	1.5	-	MHz

■ TYPICAL CHARACTERISTICS

NJM12902 Operating Current vs. Operating Voltage

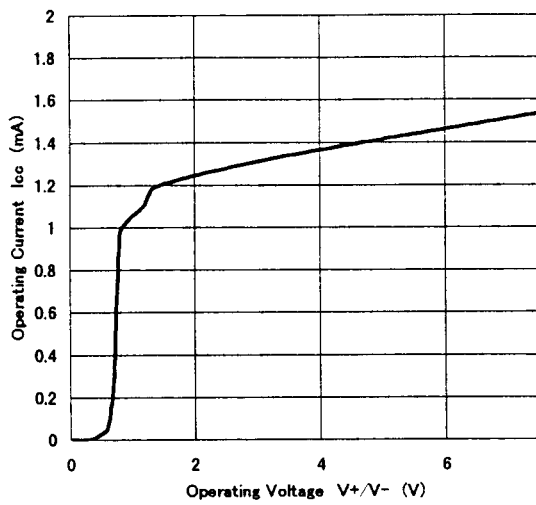

NJM12902 Input Offset Voltage vs. Operating Voltage

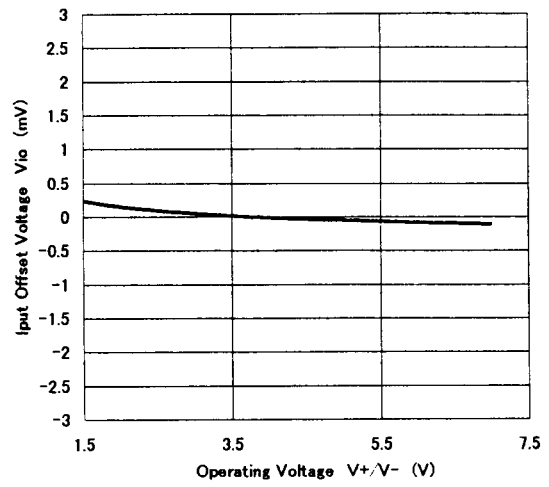

NJM12902 Input Bias Current vs. Operating Voltage

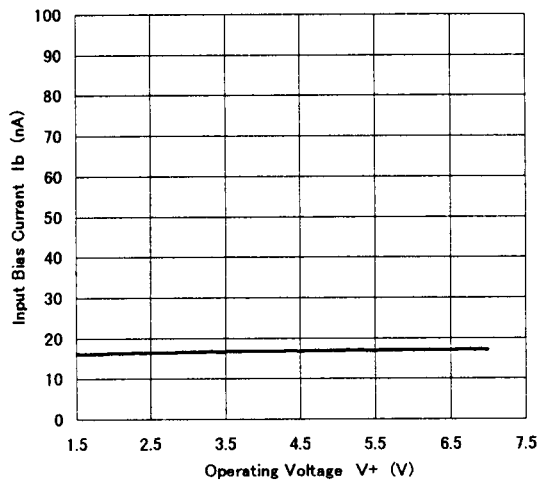

NJM12902 Maximum Output Voltage Swing vs. Operating Voltage

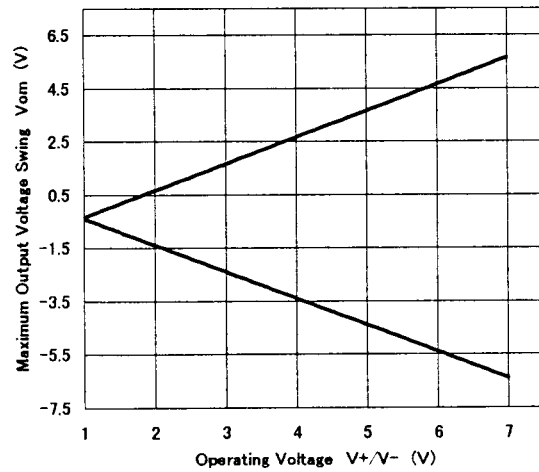

NJM12902 Input Common Mode Voltage Range

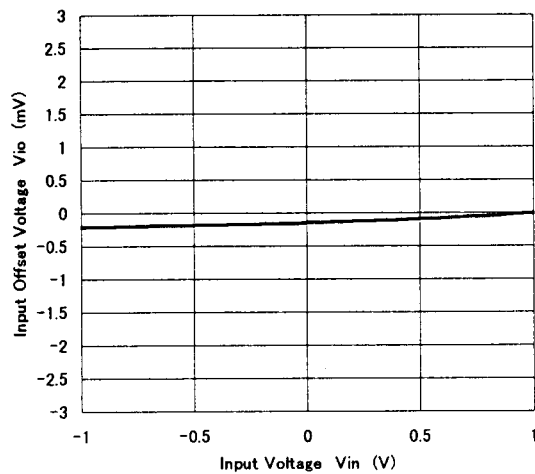

NJM12902

■ TYPICAL CHARACTERISTICS

NJM12902 Output Voltage vs. Output Sink Current

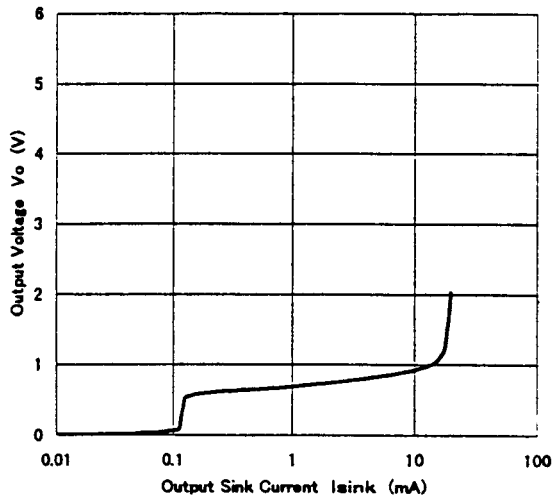

NJM12902 Maximum Output Voltage Swing vs. Frequency

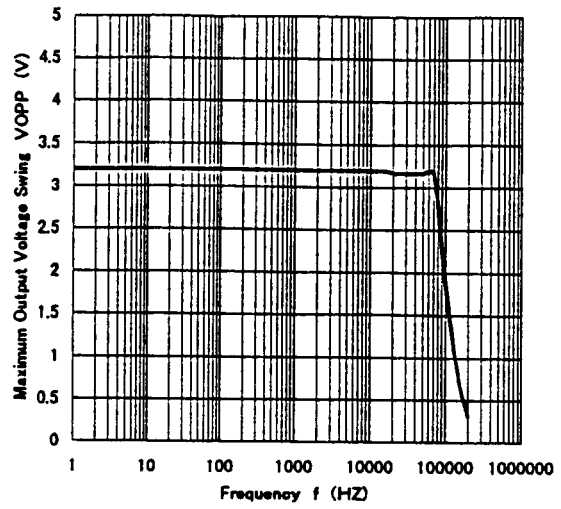

NJM12902 Output Voltage vs. Output Source Current

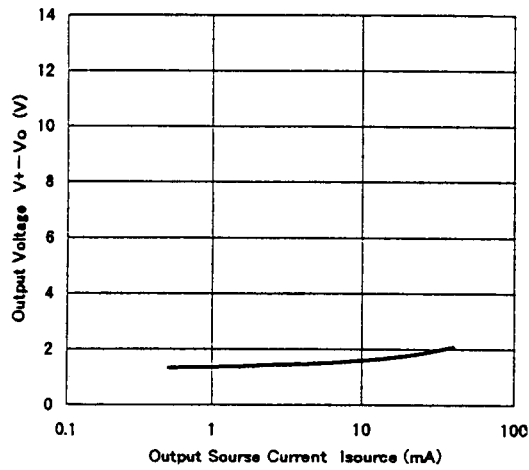

■ TYPICAL CHARACTERISTICS

NJM12902 Large Signal Voltage Gain vs. Operating Voltage

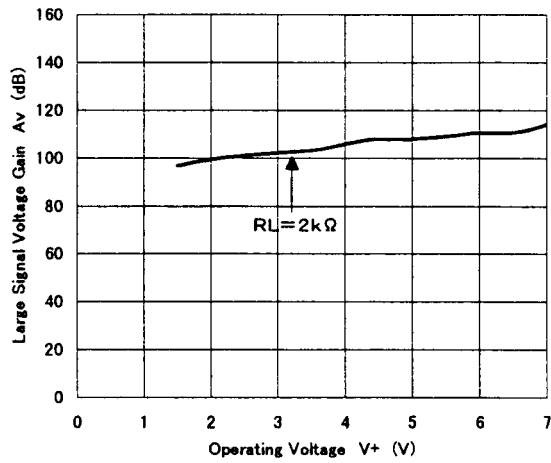

NJM12902 Large Signal Voltage Gain vs. Frequency

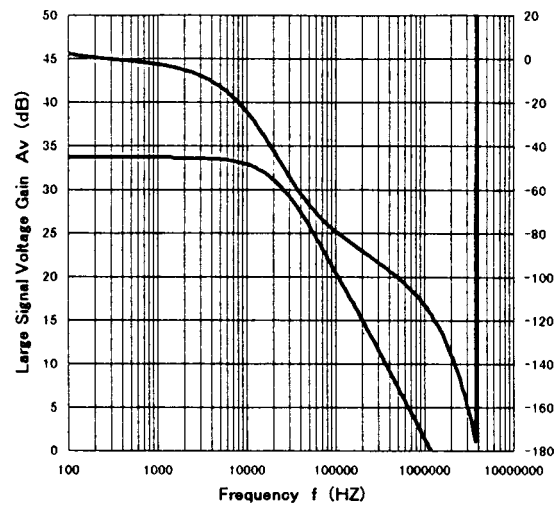

NJM12902 Slew Rate(Fall)

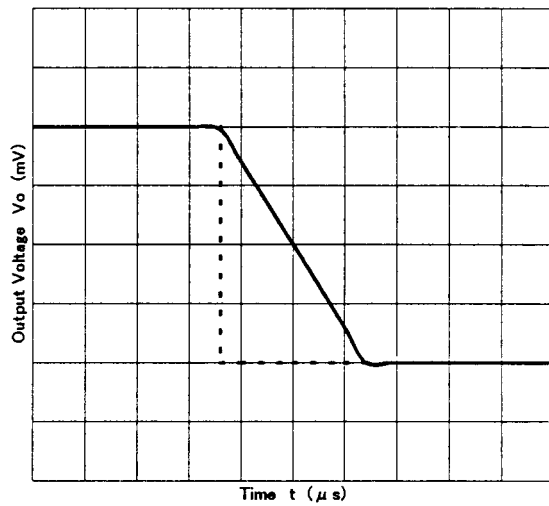

NJM12902 Slew Rate(Rise)

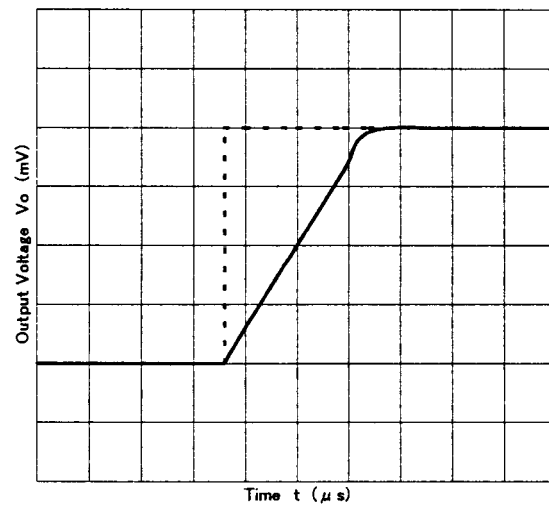

NJM12902

■ TYPICAL CHARACTERISTICS

NJM12902 Operating Current vs. Temperature

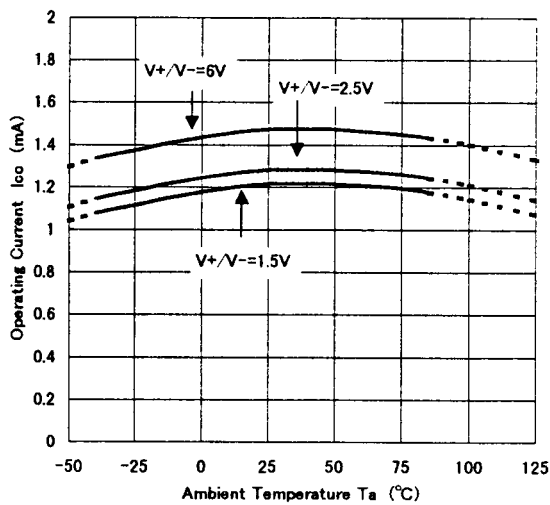

NJM12902 Input Offset Voltage vs. Temperature

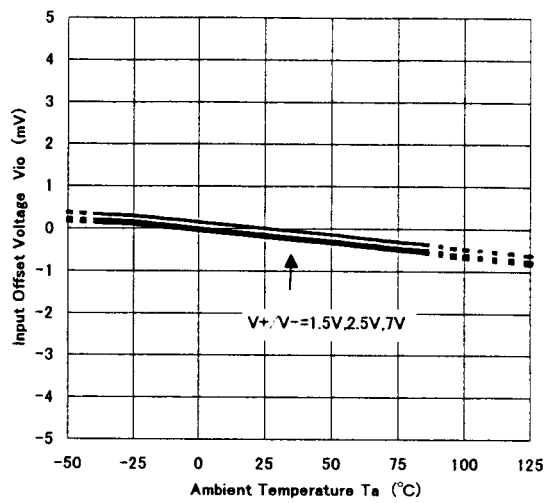

NJM12902 Input Bias Current vs. Temperature

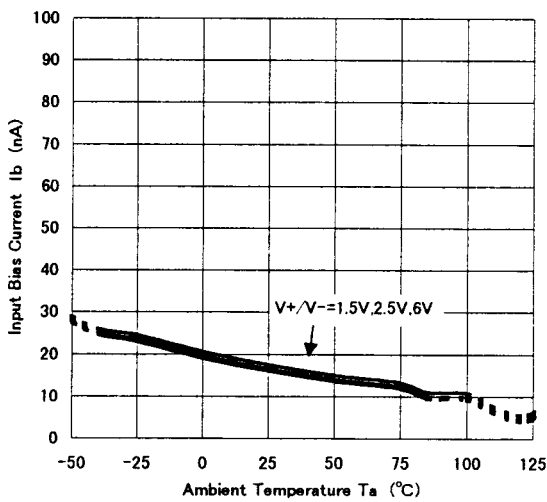

NJM12902 Maximum Output Voltage Swing vs. Temperature

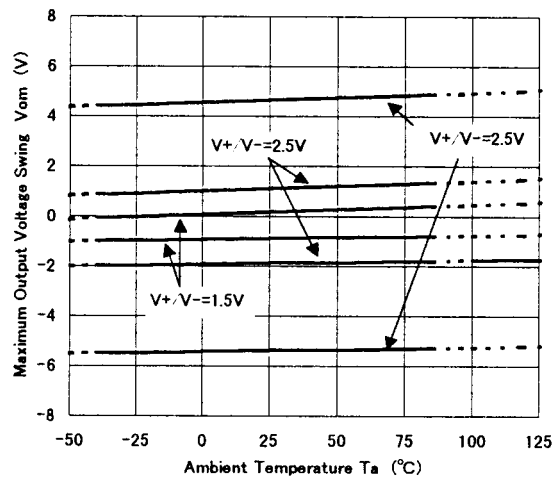

NJM12902 Output Sink Current vs. Temperature

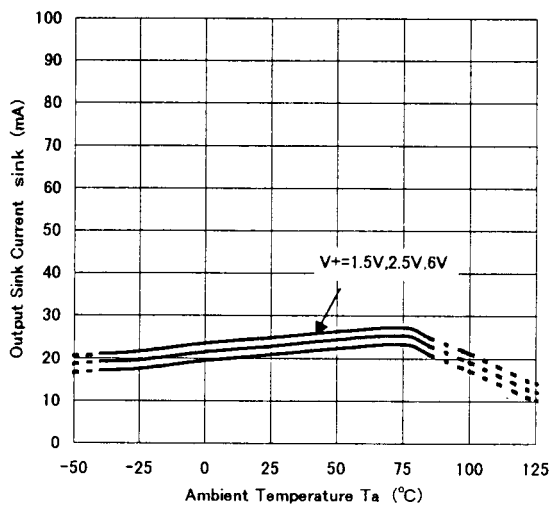

NJM12902 Output Source Current vs. Temperature

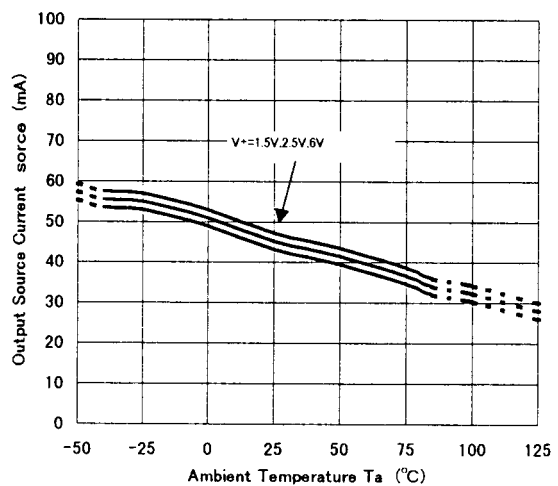

■ TYPICAL CHARACTERISTICS

NJM12902 Large Signal Voltage Gain vs. Temperature

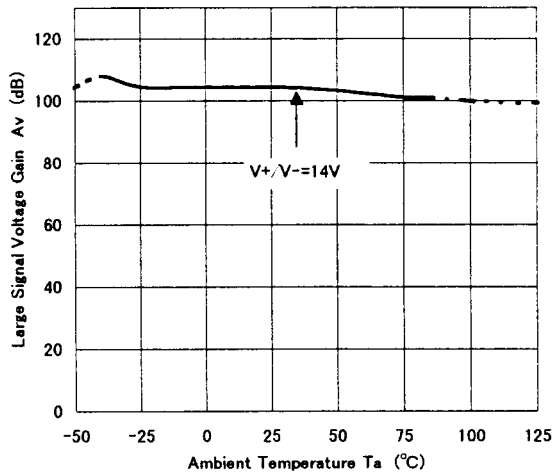

NJM12902 Common Mode Rejection Ratio vs. Temperature

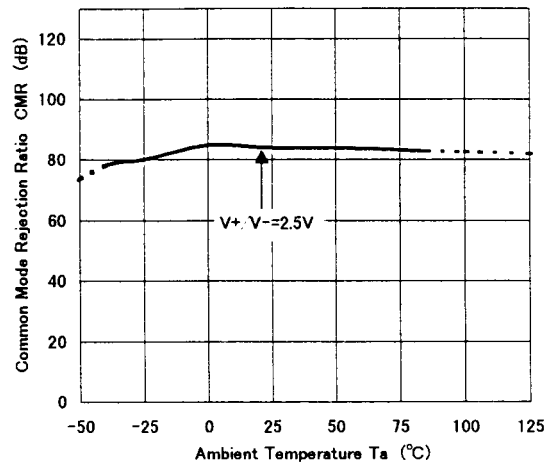

NJM12902 Supply Voltage Rejection Ratio vs. Temperature

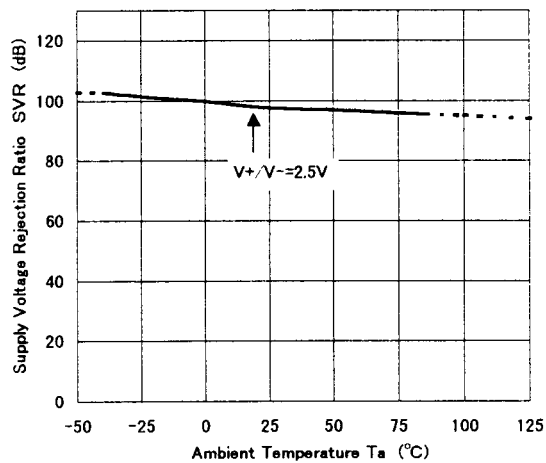

[CAUTION]

The specifications on this databook are only given for information, without any guarantee as regards either mistakes or omissions. The application circuits in this databook are described only to show representative usages of the product and not intended for the guarantee or permission of any right including the industrial rights.