

Adjustable High Precision Shunt Regulator

■ GENERAL DESCRIPTION

The NJM2373/73A and NJM2376 are adjustable high precision shunt regulators.

The output voltage can be adjusted to any value between reference voltage and 14V by two extend resistors.

■ PACKAGE OUTLINE

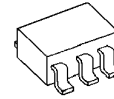

NJM2373F/AF
NJM2376F



NJM2373U / AU
NJM2376U

■ FEATURES

- Operating Voltage (V_{REF} to 13V)
- High Precision Reference Voltage

NJM2373	1.25V±2%
NJM2373A/76	1.25V±1%
- Minimum External Parts
- Bipolar Technology
- Package Outline MTP5 , SOT-89

■ BLOCK DIAGRAM

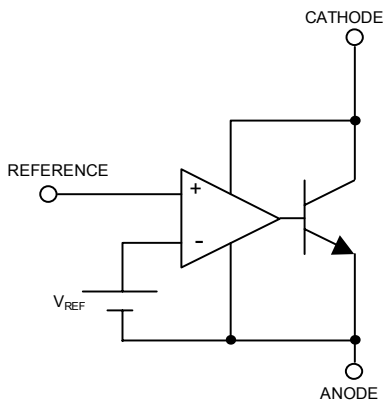

■ PIN CONFIGURATION

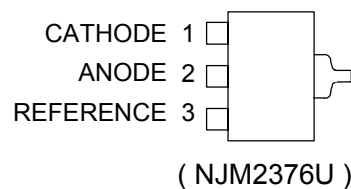
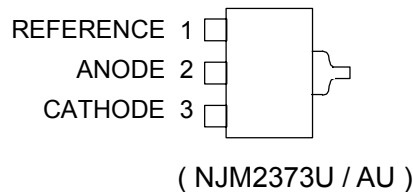
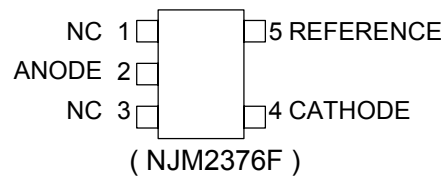
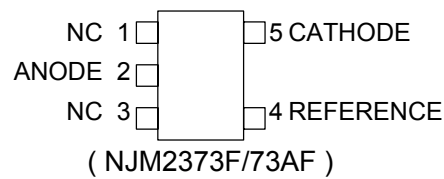

NJM2373/73A/76

■ ABSOLUTE MAXIMUM RATINGS (Ta=25°C)

PARAMETER	SYMBOL	RATINGS	UNIT
Cathode Voltage	V_{KA}	+14	V
Continuous Cathode Current	I_{KA}	-30 to 50	mA
Reference Input Current	I_{REF}	-10 to 0.05	mA
Power Dissipation	P_D (MTP5) (SOT-89)	250	mW
		350	
Operating Temperature Range	T_{opr}	-40 to +85	°C
Storage Temperature Range	T_{stg}	-40 to +150	°C

■ RECOMMENDED OPERATING CONDITIONS (Ta=25°C)

PARAMETER	SYMBOL	MIN.	TYP.	MAX.	UNIT
Cathode Voltage	V_{KA}	V_{REF}	—	13	V
Cathode Current	I_K	1	—	30	mA

■ ELECTRICAL CHARACTERISTICS (I_K=1mA, Ta=25°C)

PARAMETER	SYMBOL	CONDITIONS	MIN.	TYP.	MAX.	UNIT
Reference Voltage	V_{REF}	$V_{KA}=V_{REF}$ (*1) . NJM2373	1225	1250	1275	mV
		$V_{KA}=V_{REF}$ (*1) , NJM2373A NJM2376	1237.5	1250	1262.5	
Reference Voltage Change vs. Cathode Voltage Change	$\Delta V_{REF}/\Delta V_{REF}$	$ V_{REF} \leq V_{KA} \leq 5V$ (*2)	—	—	±2.7	mV/V
		$5V \leq V_{KA} \leq 13V$ (*2)	—	—	±2.0	mV/V
Reference Input Current	I_{REF}	$V_{KA}=V_{REF}$ $R1=10k\Omega, R2=\infty$ (*2)	—	2.0	4.0	μA
Minimum Input Current	I_{MIN}	$V_{KA}=V_{REF}, \Delta V_{REF}=-1\%$ (*1)	—	0.4	1.0	μA
Cathode Current (Off Cond.)	I_{OFF}	$V_{KA}=13V, V_{REF}=0V$ (*3)	—	0.01	1.0	μA
Dynamic Impedance	$ Z_{KA} $	$V_{KA}=V_{REF}, f \leq 1kHz$ $1mA \leq I_K \leq 100mA$ (*1)	—	0.12	—	Ω

■ TEMPERATURE CHARACTERISTICS (I_K=10mA, Ta=-20 to +85°C)

PARAMETER	SYMBOL	CONDITIONS	MIN.	TYP.	MAX.	UNIT
Reference Voltage Change	ΔV_{REF}	$V_{KA}=V_{REF}$ (*1)		±10		mV
Reference Input Current Change	ΔI_{REF}	$V_{KA}=V_{REF}$ $R1=10k\Omega, R2=\infty$ (*2)		0.5		μA

$|V_{REF}|$ ••• Reference Voltage includes error.

(*1) : TEST CIRCUIT1(Fig.1)

(*2) : TEST CIRCUIT2(Fig.2)

(*3) : TEST CIRCUIT3(Fig.3)

TEST CIRCUIT

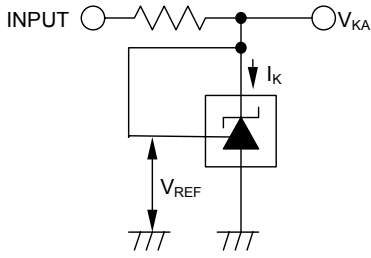

1. $V_{KA} = V_{REF}$

$V_O = V_{KA} = V_{REF}$

(Fig.1)

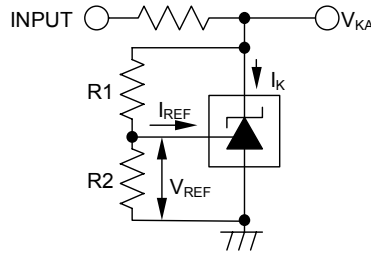

2. $V_{KA} > V_{REF}$

$V_O = V_{KA} = V_{REF}(1 + R1/R2) + I_{REF} \cdot R1$

(Fig.2)

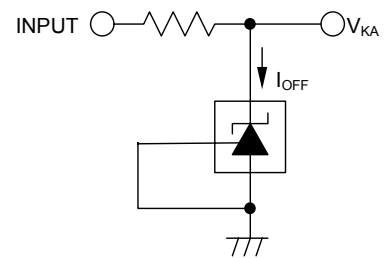

3. I_{OFF}

(Fig.3)

TYPICAL CHARACTERISTICS

Power Dissipation VS. Ambient Temperature

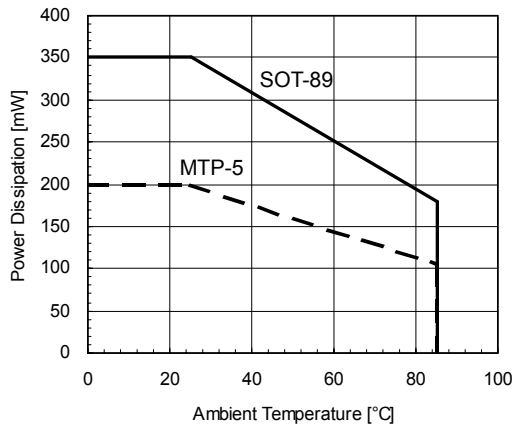

Reference Voltage VS. Ambient Temperature
 $I_K = 1\text{mA}, V_{KA} = V_{REF}$

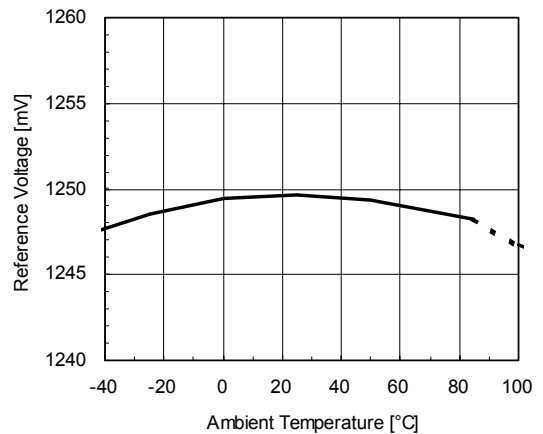

Reference Voltage VS. Cathode Current
 $V_{KA} = V_{REF}, T_a = 25^\circ\text{C}$

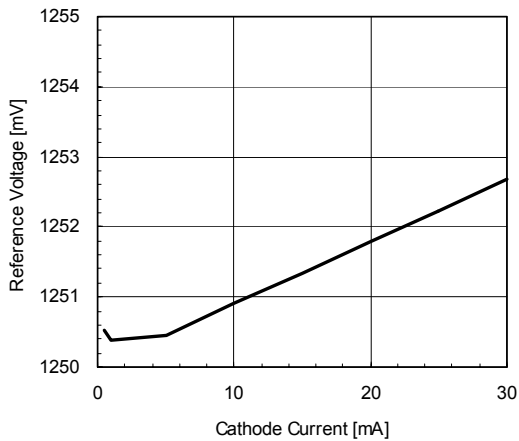

Reference Voltage VS. Cathode Current
 $V_{KA} = V_{REF}, T_a = 25^\circ\text{C}$

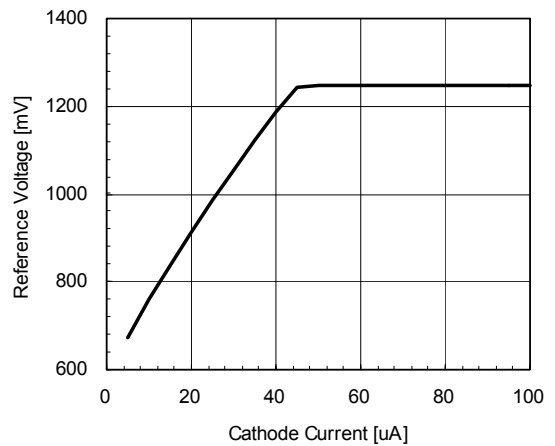

NJM2373/73A/76

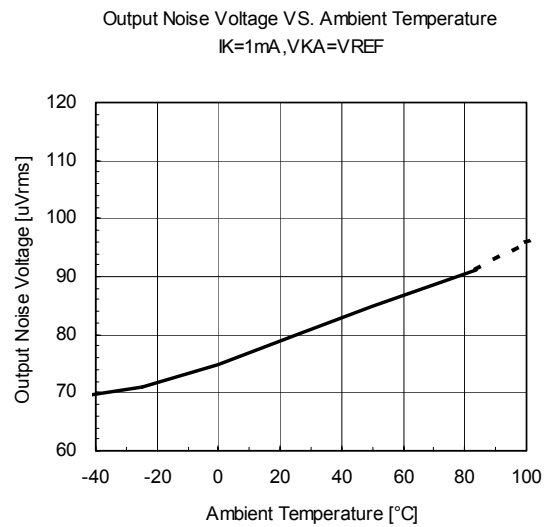
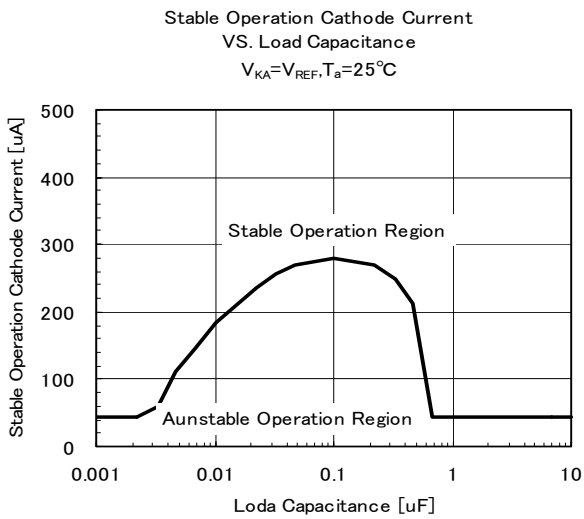
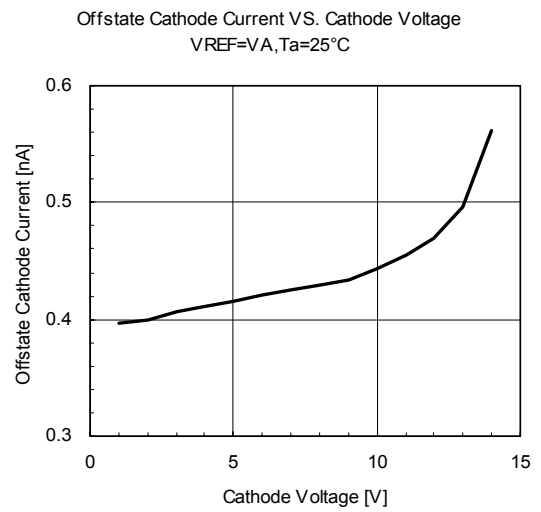
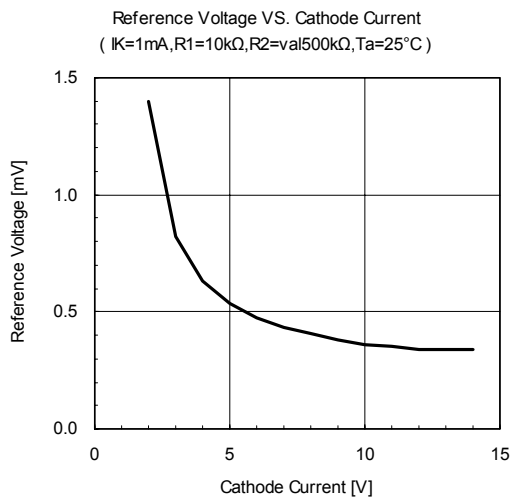

Note) Oscillation might occur while operating within the range of safety curve.

So that, it is necessary to make ample margins by taking considerations of fluctuation of the device

Reference Input Current VS. Ambient Temperature
 $I_K=1\text{mA}, R_1=10\text{k}\Omega, R_2=\infty$

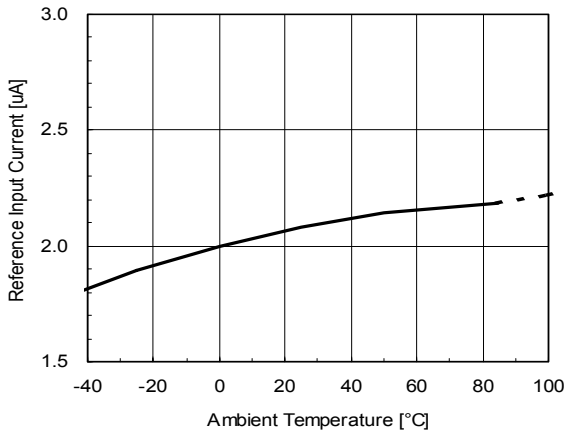

Output Noise Voltage VS. Ambient Temperature
 $I_K=1\text{mA}, V_{KA}=V_{REF}$

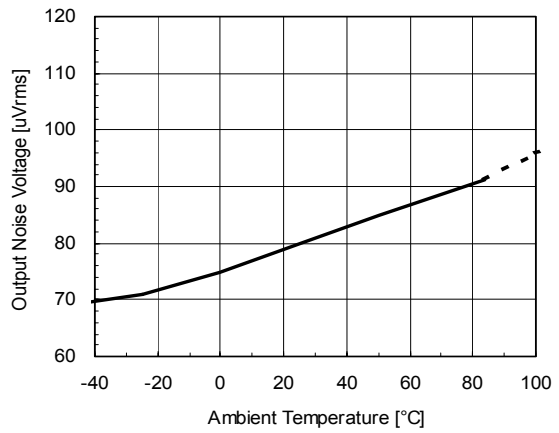

Dynamic Impedance VS. Frequency
 $I_K=1\text{mA}, V_{KA}=V_{REF}, T_a=25^\circ\text{C}$

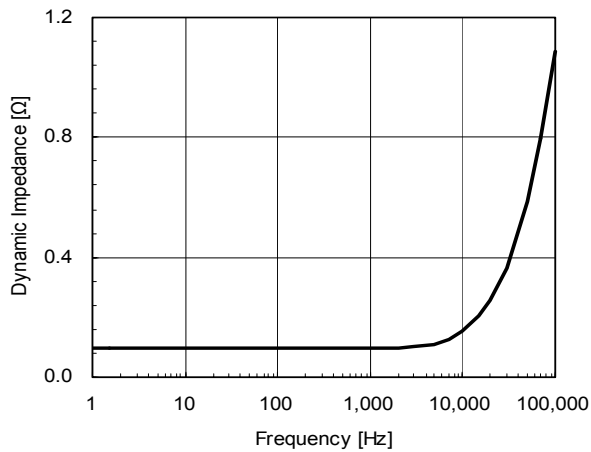

Voltage Gain VS. Frequency
 $I_K=1\text{mA}, T_a=25^\circ\text{C}$

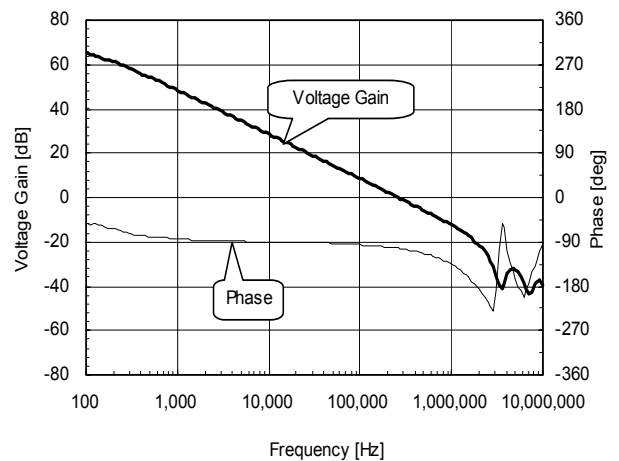

CAUTION]

The specifications on this data book are only given for information, without any guarantee as regards either mistakes or omissions. The application circuit in this data book are described only to show representative usages of the product and not intended for the guarantee or permission of any right including the industrial rights.