

LOW DROPOUT VOLTAGE REGULATOR WITH ON / OFF CONTROL

■ GENERAL DESCRIPTION

The **NJM2396** is low dropout voltage regulator with ON / OFF control.

The output current is up to 1.5A and dropout voltage is 0.2V typ. at $I_O=0.5A$.

The **NJM2396** is suitable for power module, TV, Display, car stereo and low power applications.

■ PACKAGE OUTLINE

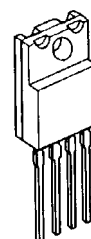

NJM2396F

■ FEATURE

- Low Dropout Voltage $\Delta V_{I-O}=0.2V$ typ. at $I_O=0.5A$
- Output Current I_O (max.)=1.5A
- ON / OFF Control
- Internal Short Circuit Current Limit
- Internal Thermal Overload Protection
- Bipolar Technology
- Package Outline TO-220F (4pin)

■ PIN CONFIGURATION

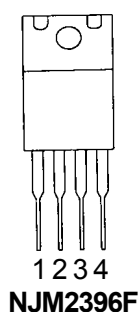

PIN FUNCTION

1. IN
2. OUT
3. GND
4. ON / OFF CONTROL
 "H" or OPEN : ON
 "L" : OFF

■ ABSOLUTE MAXIMUM RATINGS

($T_a=25^\circ C$)

PARAMETER	SYMBOL	RATINGS	UNIT
Input Voltage	V_{IN}	+35	V
Control Voltage	V_{CONT}	+35(*1)	V
Output Current	I_O	1.5	A
Power Dissipation	P_D	18 ($T_C<50^\circ C$)	W
Operating Junction Temperature Range	T_j	-40 to +150	$^\circ C$
Operating Temperature Range	T_{opr}	-40 to 85	$^\circ C$
Storage Temperature Range	T_{stg}	-50 to 150	$^\circ C$

(*1) : When input voltage is less than +35V, the absolute maximum control voltage is equal to the input voltage.

NJM2396

■ ELECTRICAL CHARACTERISTICS ($V_{IN}=V_O+1V$, $I_O=0.5A$, $C_{IN}=0.33\mu F$, $C_O=22\mu F$, $T_J=25^\circ C$)

Measurement is to be conducted is pulse testing.

PARAMETER	SYMBOL	CONDITIONS	MIN.	TYP.	MAX.	UNIT
Output Voltage	V_O	$V_{IN}=V_O+1V$	-4%	-	+4%	V
Line Regulation	$\Delta V_O/V_{IN}$	$V_{IN}=V_O+1V$ to V_O+17V	-	0.04	0.16	% / V
Load Regulation	$\Delta V_O/I_O$	$V_{IN}=V_O+2V$, $I_O=0A$ to $1.5A$	-	0.2	1.4	% / A
Average Temperature Coefficient of Output Voltage	$\Delta V_O/\Delta T$	$T_J=0$ to $125^\circ C$	-	± 0.02	-	% / $^\circ C$
Standby Current	I_Q	$I_O=0A$	-	-	5	mA
Dropout Voltage	ΔV_{TO}	$I_O=0.5A$	-	0.2	0.5	V
Ripple Rejection	NJM2396F33	RR $V_{IN}=V_O+2V$ $e_{in}=0.5V_{rms}$, $f=120Hz$	52	60	-	dB
	NJM2396F05		52	60	-	
	NJM2396F63		52	60	-	
	NJM2396F08		50	58	-	
	NJM2396F09		50	58	-	
	NJM2396F12		48	58	-	
ON Control Voltage	$V_{CONT(ON)}$		2.0(*2)	-	-	V
OFF Control Voltage	$V_{CONT(OFF)}$		-	-	0.4	V
ON Control Current	$I_{CONT(ON)}$	$V_C=2.7V$	-	-	20	μA
OFF Control Current	$I_{CONT(OFF)}$	$V_C=0.4V$	-	-	-20	μA

(*2) : When ON / OFF CONTROL Terminal is open, Output Voltage is ON

■ TEST CIRCUIT

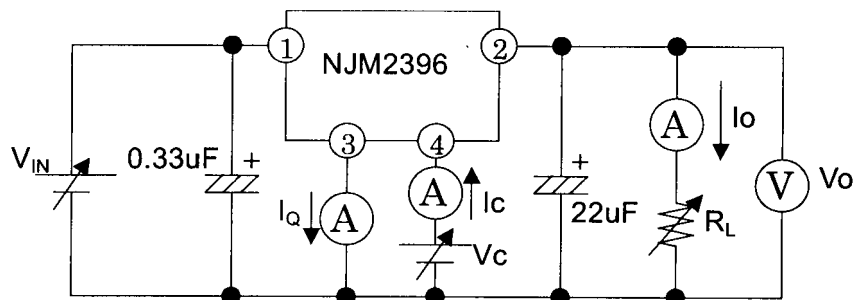

■ POWER DISSIPATION vs. AMBIENT TEMPERATURE

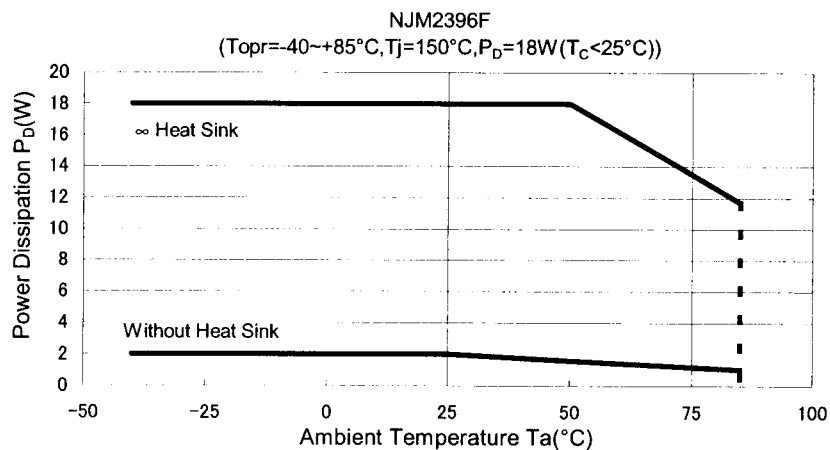

■ TYPICAL CHARACTERISTICS

NJM2396F05
Circuit operating current / Output voltage vs. input voltage

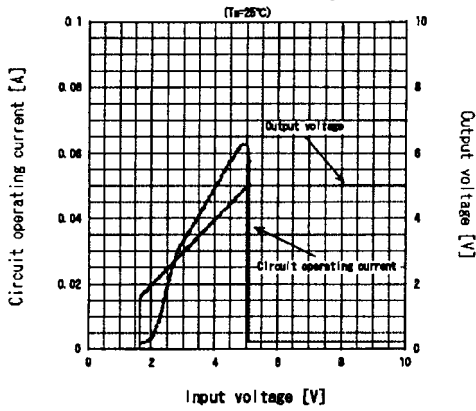

NJM2396F05
Dropout voltage vs. Output current

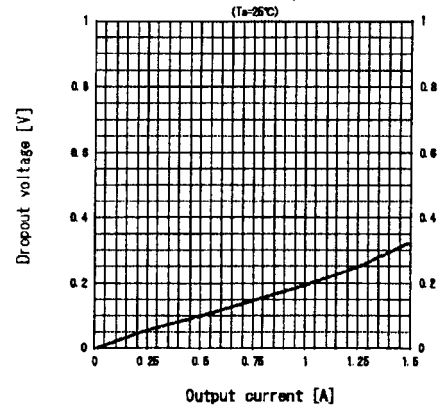

NJM2396F05
Circuit operating current vs. Output current

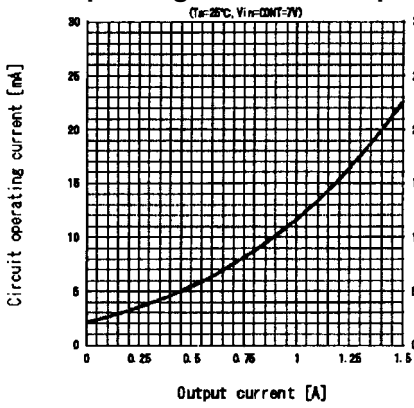

NJM2396F05
Overcurrent Protection Characteristics

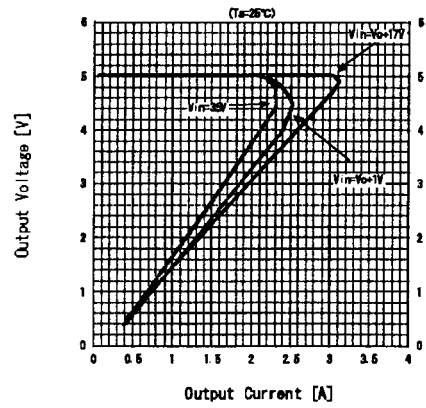

NJM2396F05
Off-state current vs. Input voltage

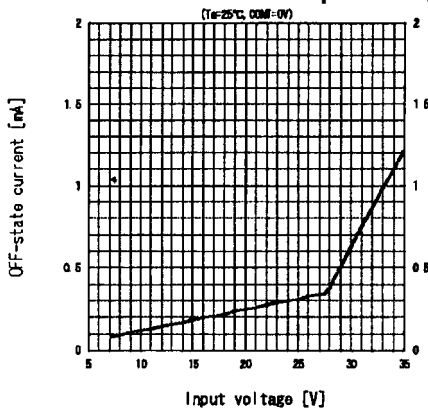

NJM2396F05
Output stability vs. Output current

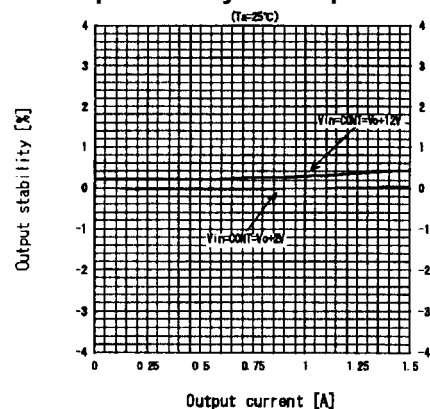

NJM2396

■ TYPICAL CHARACTERISTICS

NJM2396F05
Ripple rejection ratio vs. Input ripple frequency

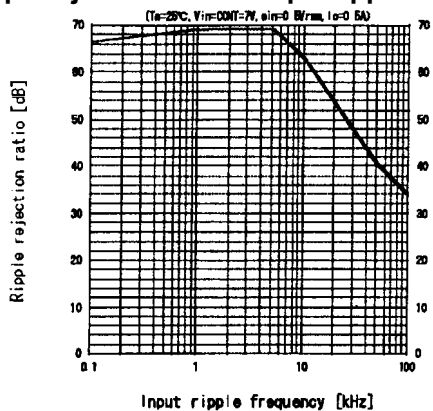

NJM2396F05
Output noise voltage vs. Output current

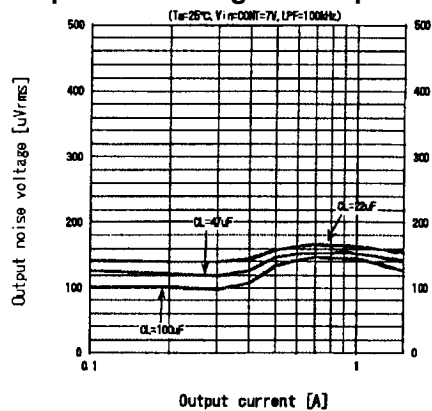

NJM2396F05
Ripple rejection ratio vs. Ambient temperature

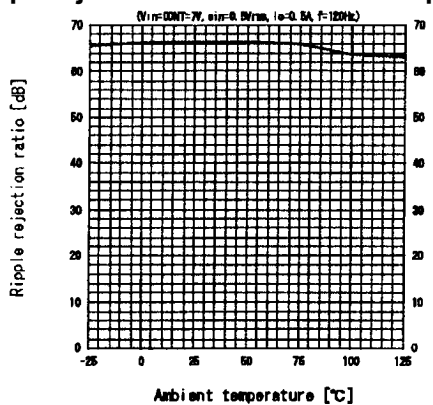

NJM2396F05
Dropout voltage vs. Ambient temperature

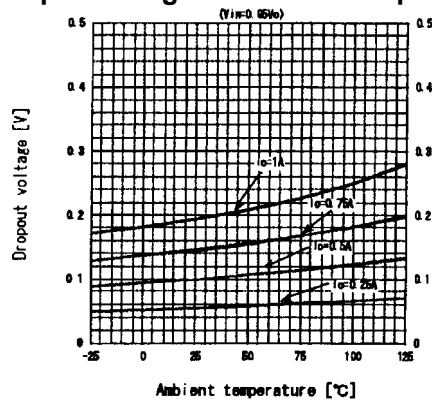

NJM2396F05
Output voltage vs. Ambient temperature

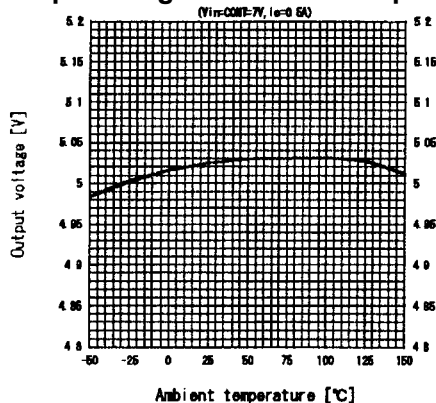

NJM2396F05
Overtemperature Protection Characteristics

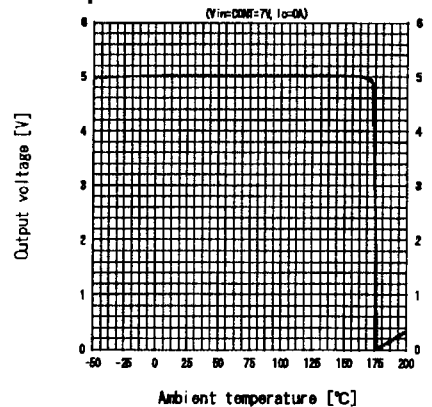

■ TYPICAL CHARACTERISTICS

NJM2396F05
Output peak current vs. Ambient temperature

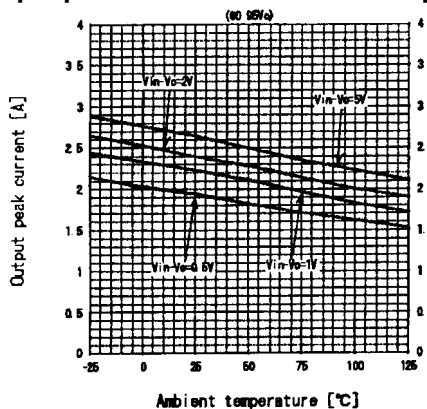

NJM2396F05
Quiescent current vs. Ambient temperature

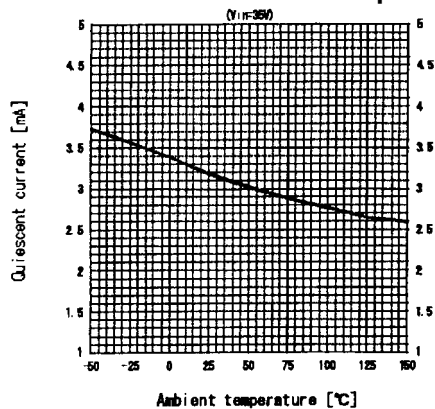

NJM2396F05
Off-state current vs. Ambient temperature

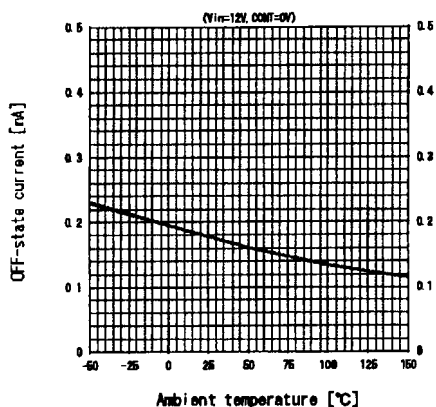

[CAUTION]

The specifications on this databook are only given for information, without any guarantee as regards either mistakes or omissions. The application circuits in this databook are described only to show representative usages of the product and not intended for the guarantee or permission of any right including the industrial rights.