

LOW VOLTAGE VIDEO AMPLIFIER WITH LPF

■GENERAL DESCRIPTION

The **NJM2574** is a Low Voltage Video Amplifier contained LPF circuit, 75Ω driver and internal CLAMP/BIAS SW, LPF/through SW to connect TV monitor directly.

The input composite signal.(0.5Vpp) The mute circuit with power save function is suitable for low power design.

The **NJM2574** is suitable for down sizing of Digital Steel Camera, and DVC for small package.

■PACKAGE OUTLINE

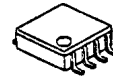

NJM2574RB1

■FEATURES

- Operating Voltage 2.8 to 5.5V
- Input Composite Signa 0.5Vpp
- Output Swing 2.4Vpp typ. at Vcc=3V,CLAMP MODE
- Internal CLAMP/BIAS SW
- Internal LPF/through SW
- Operating Current 9.0mA typ. at Vcc=3.0V
- Operating Current in Battery Saving 70uA typ. at Vcc=3.0V
- 75Ω 2 system Drive
- Bipolar Technology
- Package Outline TVSP8

■BLOCK DIAGRAM

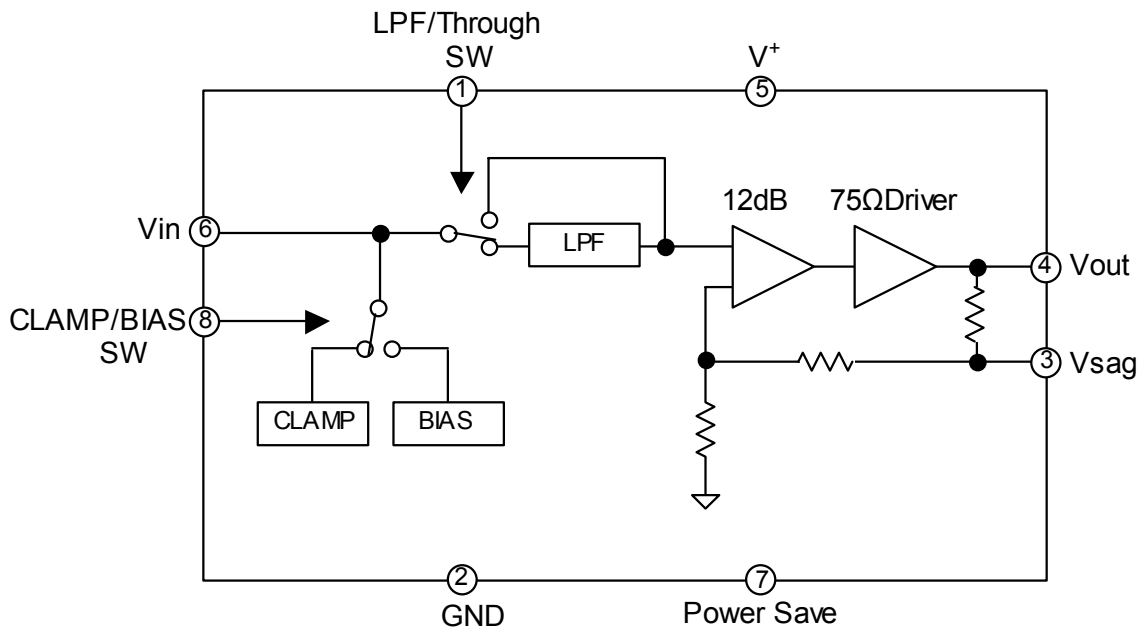

NJM2574

■ABSOLUTE MAXIMUM RATINGS

(Ta=25°C)

PARAMETER	SYMBOL	RATINGS	UNIT
Supply Voltage	V ⁺	7.0	V
Power Dissipation	P _D	320	mW
Operating Temperature Range	Topr	-40 to +85	°C
Storage Temperature Range	Tstg	-40 to +125	°C

■ELECTRICAL CHARACTERISTICS (V⁺=3.0V,RL=150Ω,Ta=25°C)

PARAMETER	SYMBOL	TEST CONDITION	MIN.	TYP.	MAX.	UNIT
Operating Voltage	Vopr		2.8	3.0	5.5	V
Operating Current	I _{CC}	No Signal	-	9.0	10.0	mA
Operating Current at Power Save	Isave	Power Save Mode	-	70	90	uA
Maximum Output Voltage Swing	Vomv	f=1kHz,THD=1%,CLAMP MODE LPF MODE	2.2	2.7	-	Vp-p
	Vom RGB	f=1kHz,THD=1%, BIAS MODE, through MODE	1.4	2.0	-	
Voltage Gain	Gv	Vin=100kHz,0.5Vp-p, Input Sine Signal	12.0	12.4	12.8	dB
Frequency Characteristic (Through MODE)	Gf	Vin=20MHz/100kHz,0.5Vp-p	-6.0	-3.0	-	dB
Low Pass Filter Characteristic	Gfy4.5M	Vin=4.5MHz/100kHz,0.5Vp-p	-0.95	-0.45	0.05	dB
	Gfy8M	Vin=8MHz/100kHz,0.5Vp-p	-	-3.0	-	
	Gfy23.5M	Vin=23.5MHz/100kHz,0.5Vp-p	-	-23	-17	
Differential Gain	DG	Vin=0.5Vp-p, Input 10step Video Signal	-	0.5	-	%
Differential Phase	DP	Vin=0.5Vp-p, Input 10step Video Signal	-	0.5	-	deg
S/N	SNv	Vin=0.5Vp-p, 100% White Video Signal, R _L =75Ω Band Width 100kHz to 6MHz	-	+60	-	dB
2nd. Distortion	Hv	Vin=0.5Vp-p, 3.58MHz, Sine Video Signal, R _L =75Ω,	-	-60	-	dB
SW Change Voltage High Level	VthH		1.8	-	V ⁺	V
SW Change Voltage Low Level	VthL		0	-	0.3	

■ CONTROL TERMINAL

PARAMETER	STATUS	NOTE
Power Save(7pin)	H	Power Save : OFF
	L	Power Save : ON
	OPEN	Power Save : ON
LPF/Through SW(1pin)	H	LPF MODE
	L	Through MODE
	OPEN	Through MODE

TEST CIRCUIT

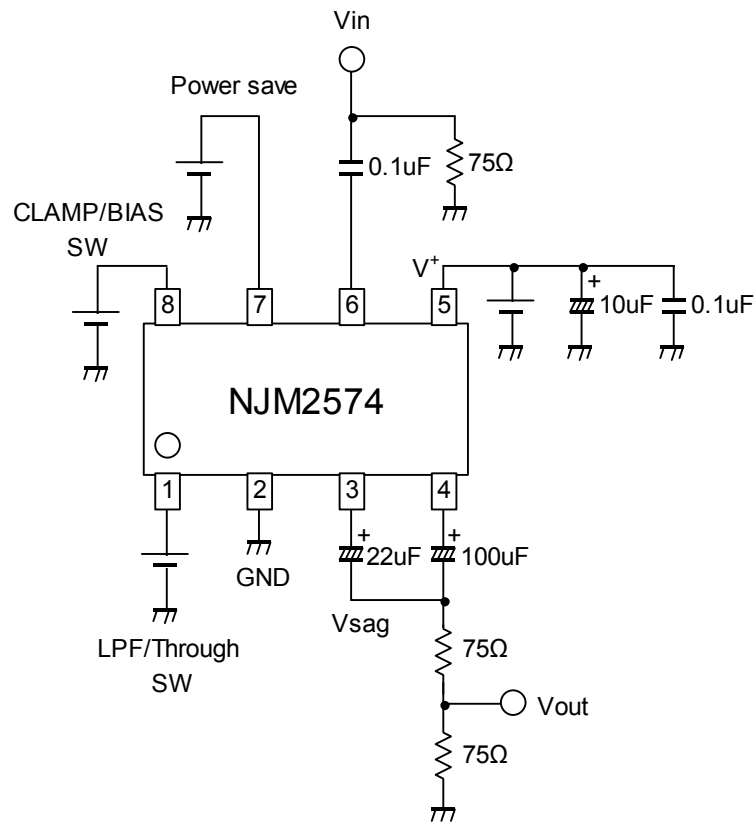

APPLICATION CIRCUIT

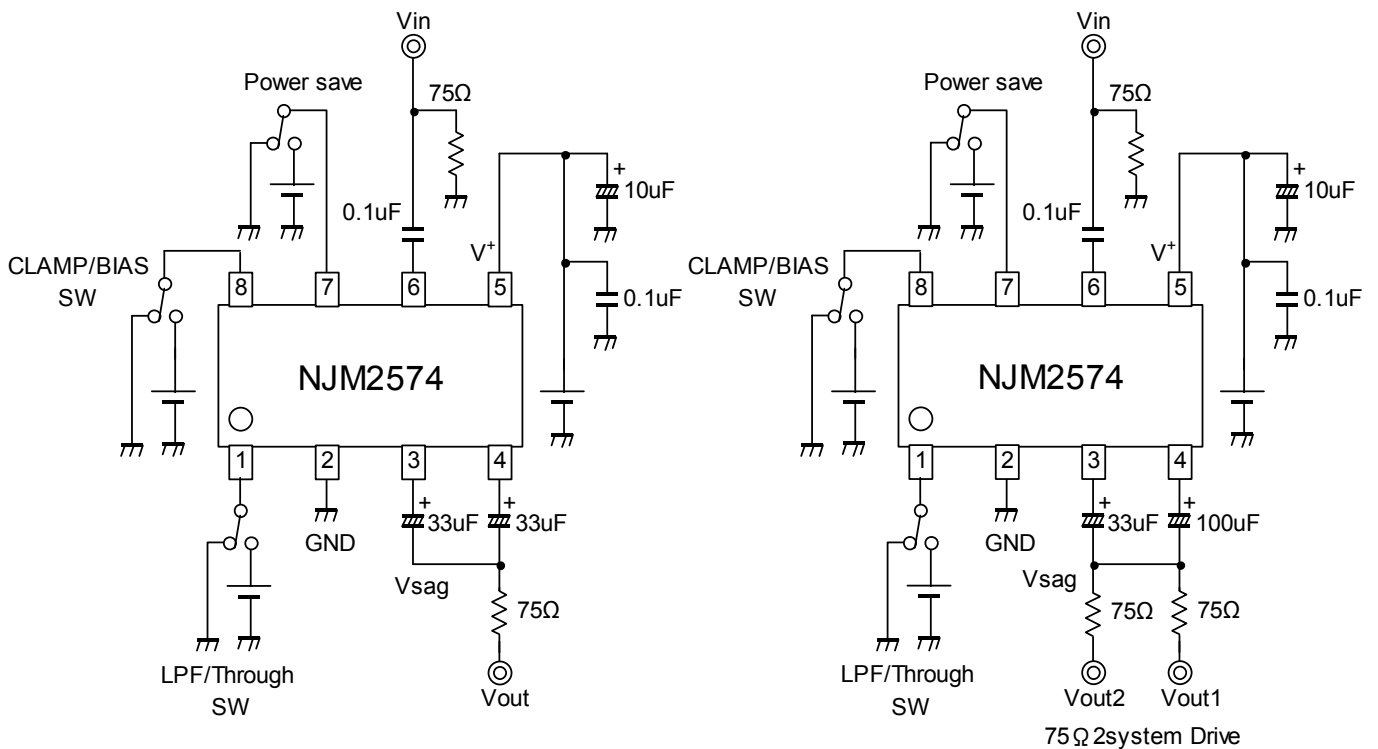

NJM2574

■ TYPICAL CHARACTERISTICS

Voltage Gain vs. Frequency

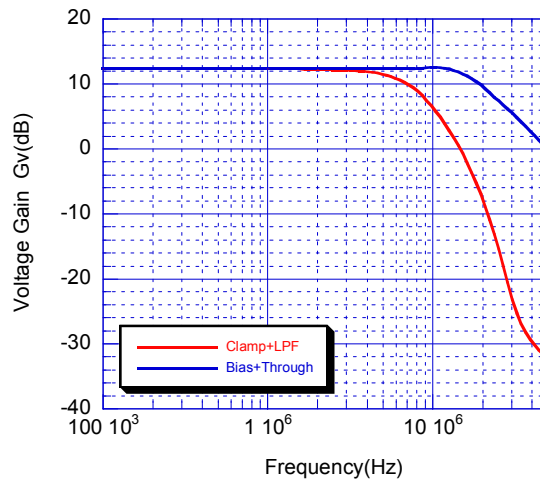

Voltage Gain vs. Frequency
(Clamp+LPF Input)

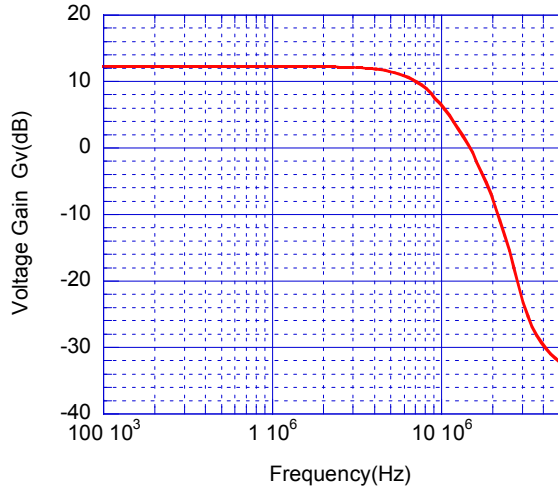

Voltage Gain vs. Frequency
(Bias+Through Input)

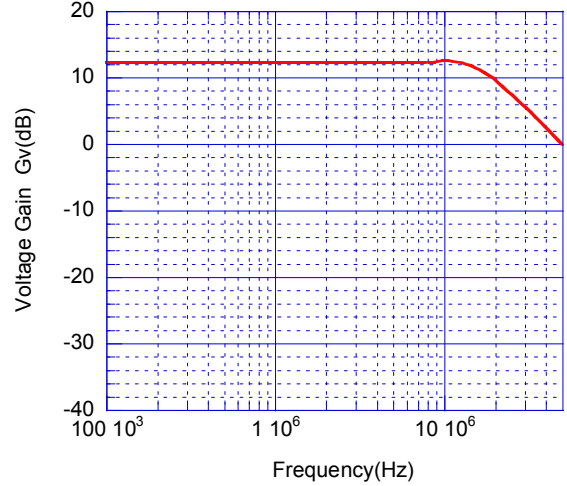

Operating Current vs. Supply Voltage

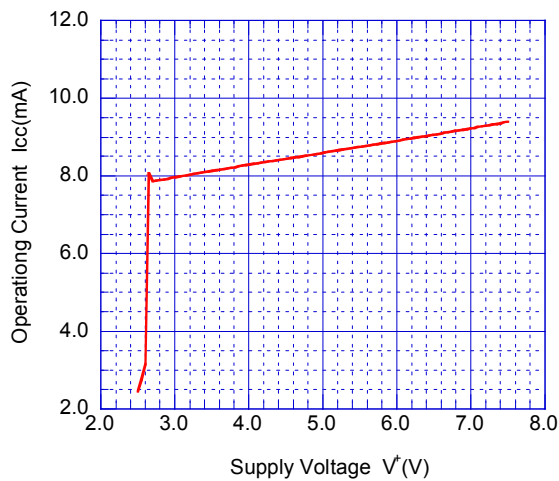

Operating Current at Standby State
vs. Supply Voltage

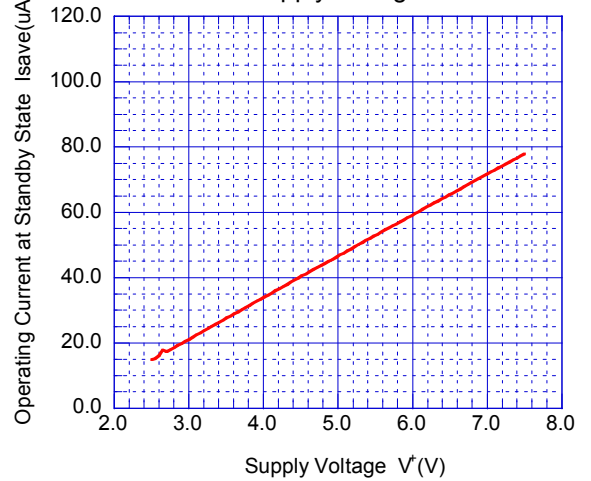

■ TYPICAL CHARACTERISTICS

Maximum Output Voltage Swing vs. Supply Voltage
(Clamp+LPF Type Input)

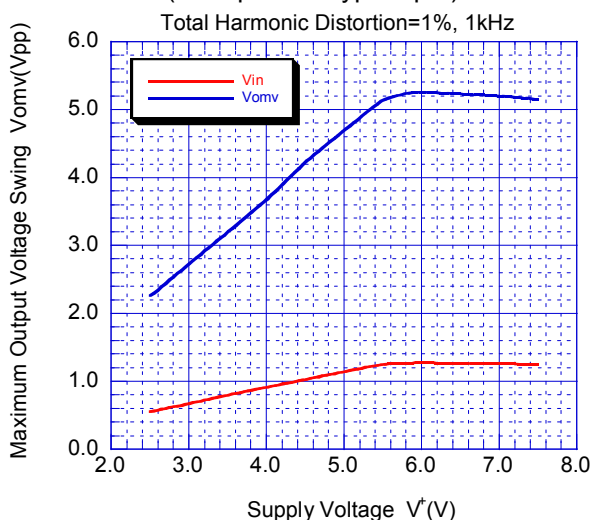

Maximum Output Voltage Swing vs. Supply Voltage
(Bias+Through Type Input)

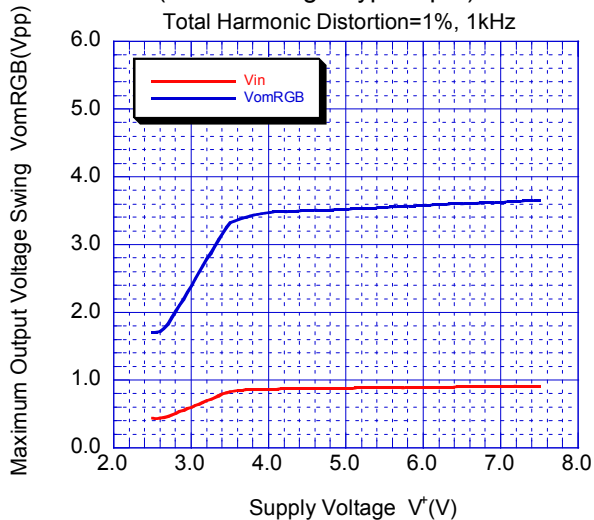

Voltage Gain vs. Supply Voltage
0.5Vpp, 100kHz sinewave signal input

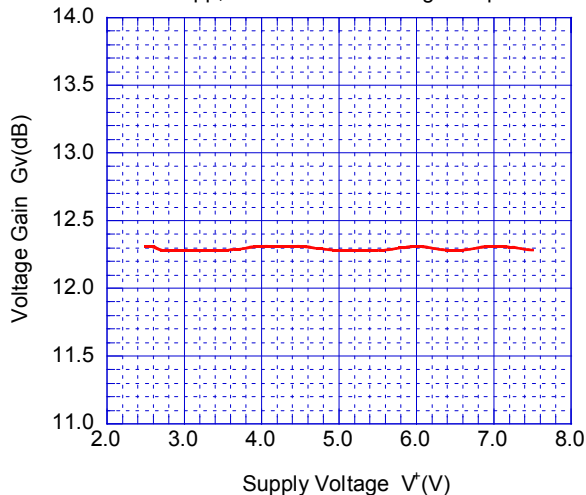

Gain Frequency Characteristics vs. Supply Voltage
(Bias+Through Type Input)

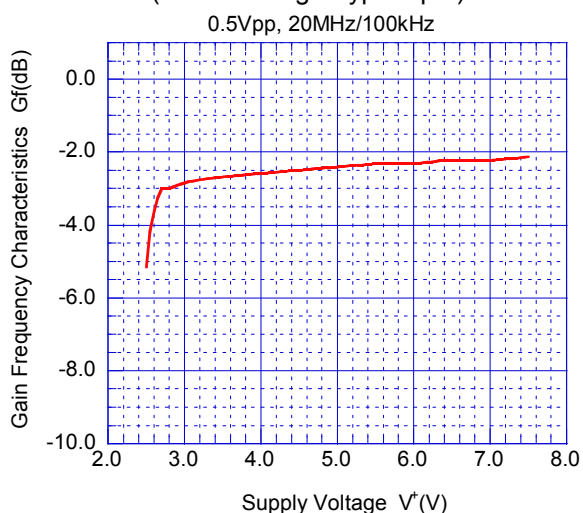

Low Pass Filter Characteristic 1 vs. Supply Voltage
(Clamp+LPF Type Input)

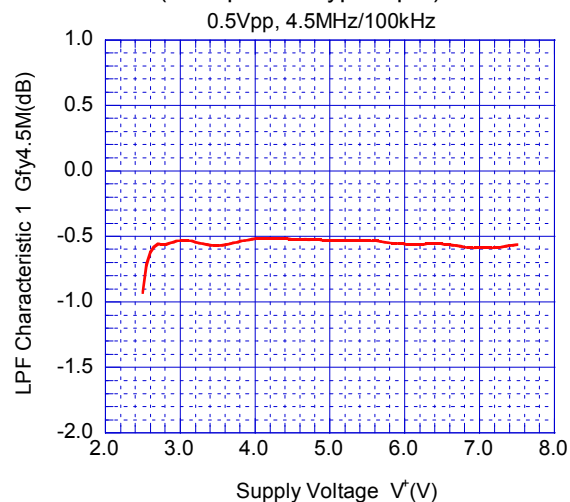

Low Pass Filter Characteristic 2 vs. Supply Voltage
(Clamp+LPF Type Input)

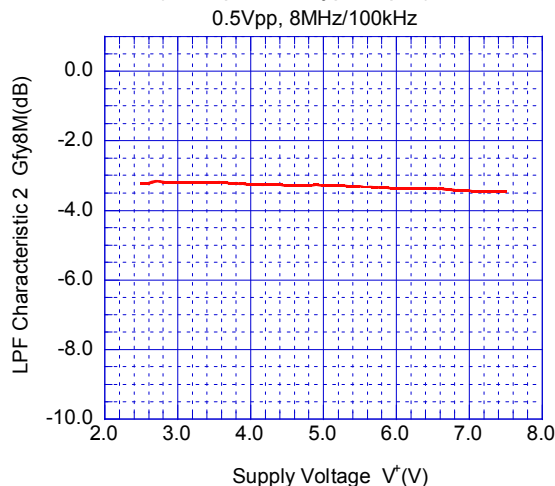

NJM2574

■ TYPICAL CHARACTERISTICS

Low Pass Filter Characteristic 3 vs. Supply Voltage
(Clamp+LPF Type Input)
0.5Vpp, 23.5MHz/100kHz

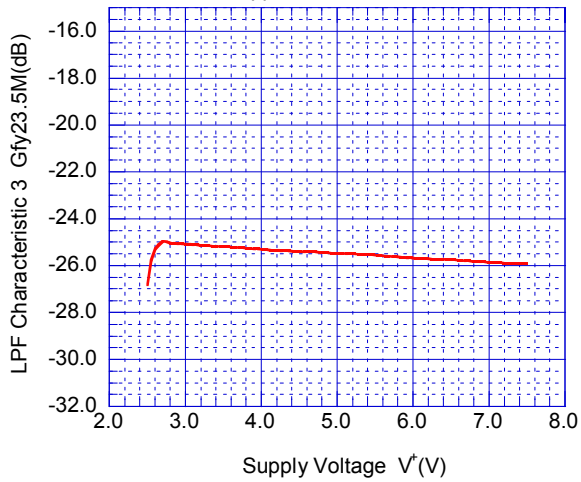

Differential Gain vs. Supply Voltage
0.5Vpp, 10step video signal input

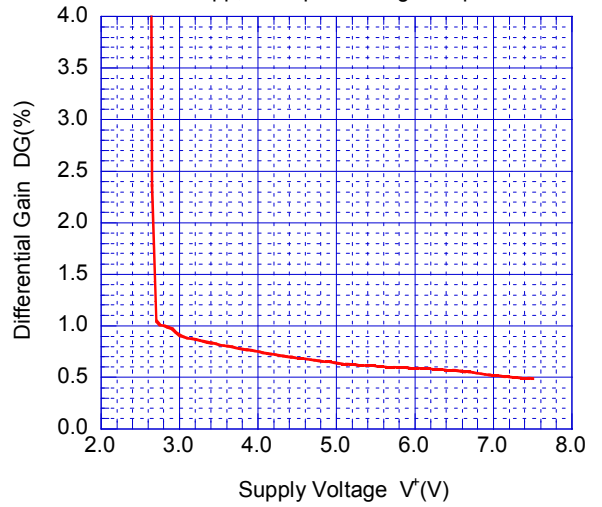

Differential Phase vs. Supply Voltage
0.5Vpp, 10step video signal input

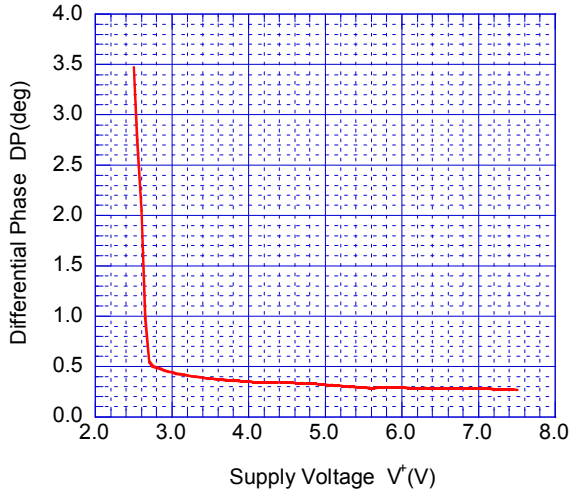

Signal to Noise Ratio vs. Supply Voltage
0.5Vpp, 100% white video signal input, 100kHz-6MHz

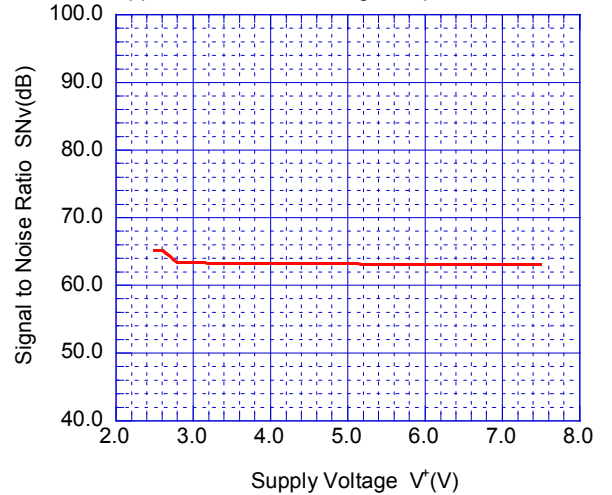

Second Harmonic Distortion vs. Supply Voltage
0.5Vpp, 3.58MHz sinewave signal input

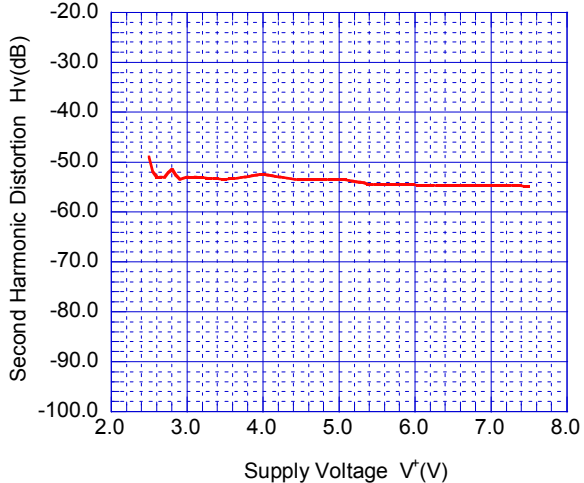

Switching Voltage vs. Supply Voltage

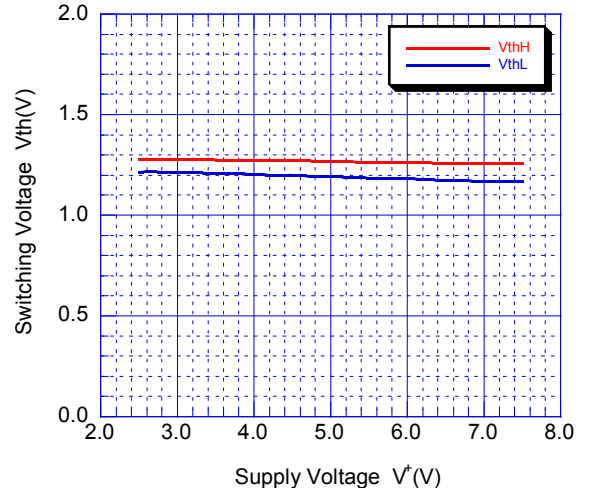

■ TYPICAL CHARACTERISTICS

PowerSave Switching Voltage vs. Supply Voltage

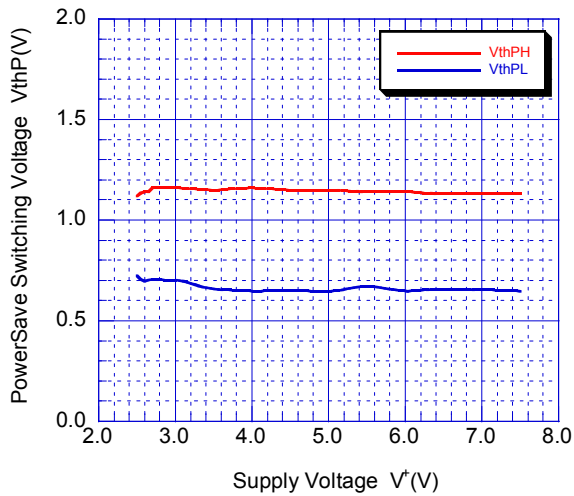

Operating Current vs. Temperature

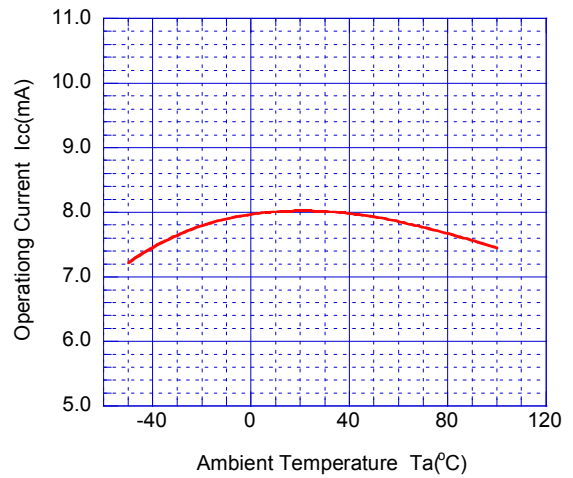

Operating Current at Standby State vs. Temperature

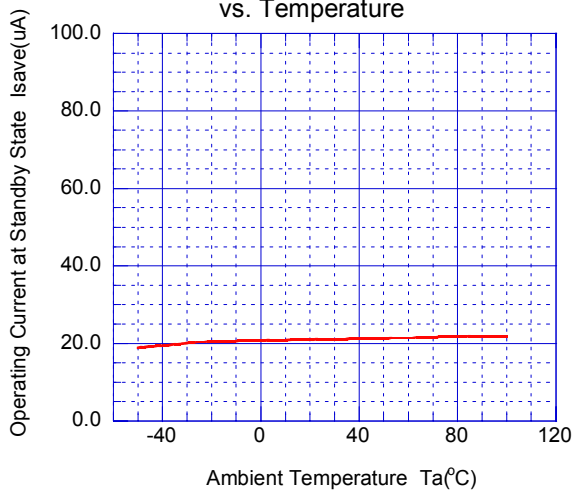

Maximum Output Voltage Swing vs. Temperature (Clamp+LPF Type Input)

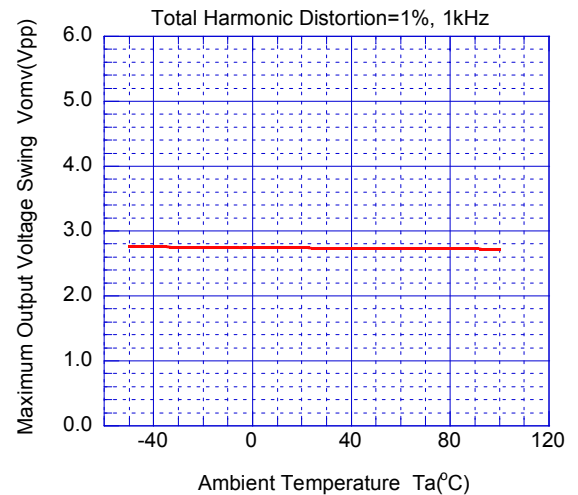

Maximum Output Voltage Swing vs. Temperature (Bias+Through Type Input)

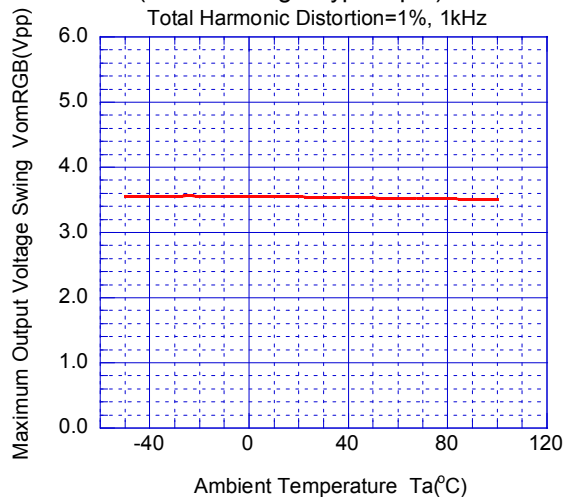

Gain Frequency Characteristics vs. Temperature (Bias+Through Type Input)

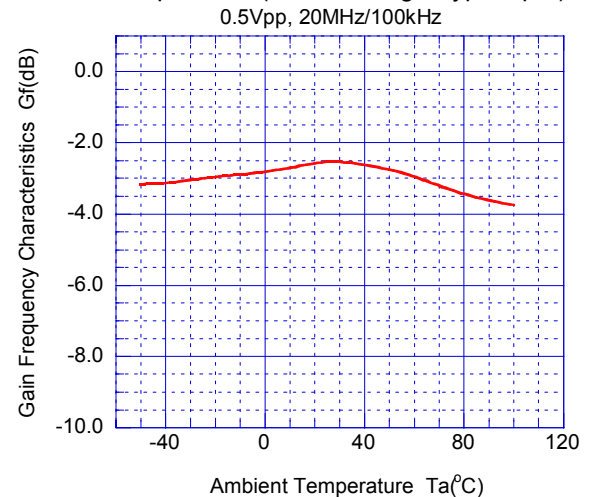

NJM2574

■ TYPICAL CHARACTERISTICS

Low Pass Filter Characteristic 1 vs. Temperature
(Clamp+LPF Type Input)
0.5Vpp, 4.5MHz/100kHz

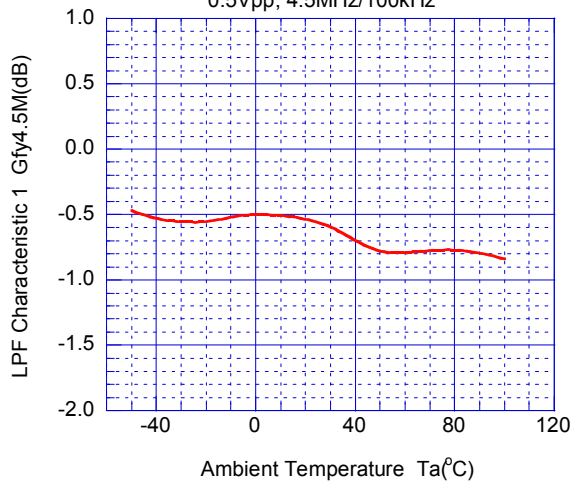

Low Pass Filter Characteristic 2 vs. Temperature
(Clamp+LPF Type Input)
0.5Vpp, 8MHz/100kHz

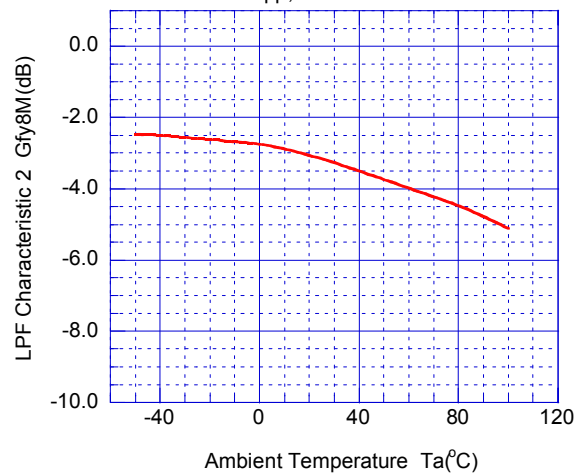

Low Pass Filter Characteristic 3 vs. Temperature
(Clamp+LPF Type Input)
0.5Vpp, 23.5MHz/100kHz

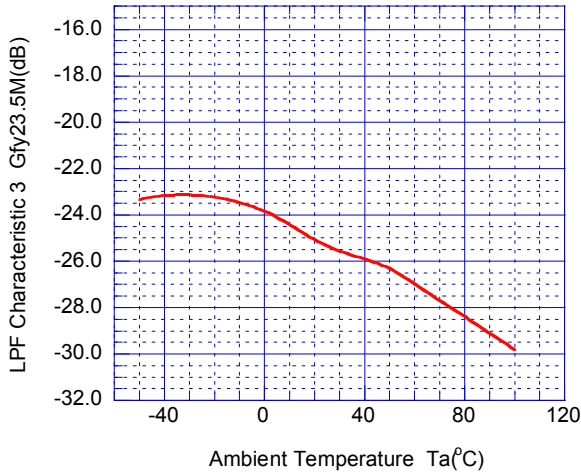

Differential Gain vs. Temperature
0.5Vpp, 10step video signal input

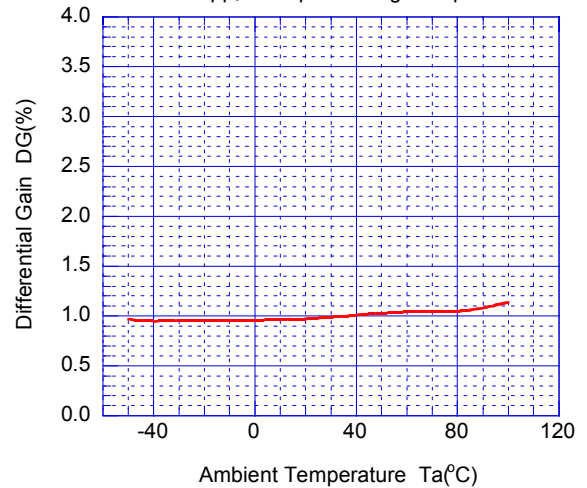

Differential Phase vs. Temperature
0.5Vpp, 10step video signal input

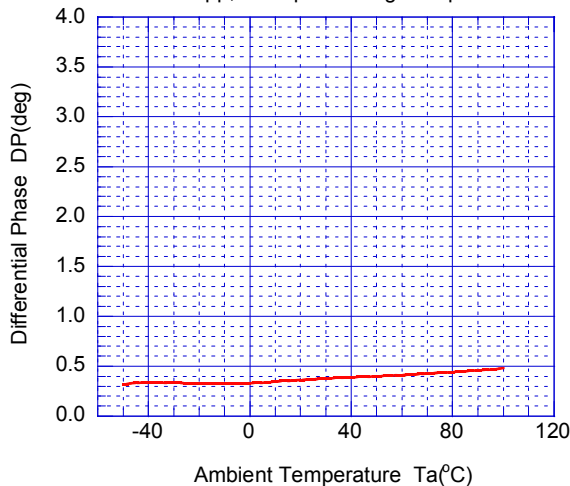

Signal to Noise Ratio vs. Temperature

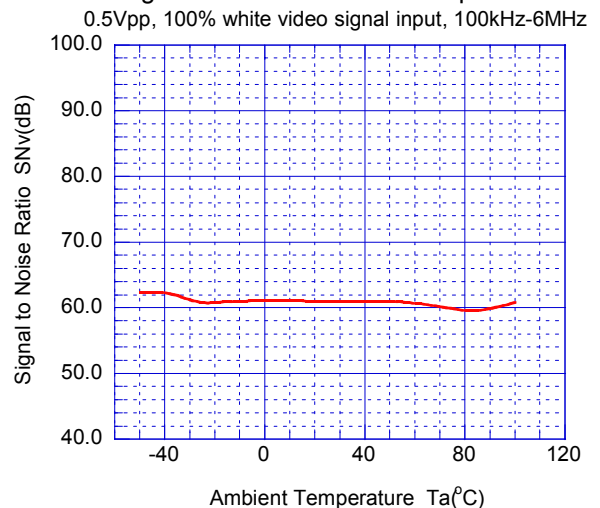

■ TYPICAL CHARACTERISTICS

Second Harmonic Distortion vs. Temperature
0.5Vpp, 3.58MHz sinewave signal input

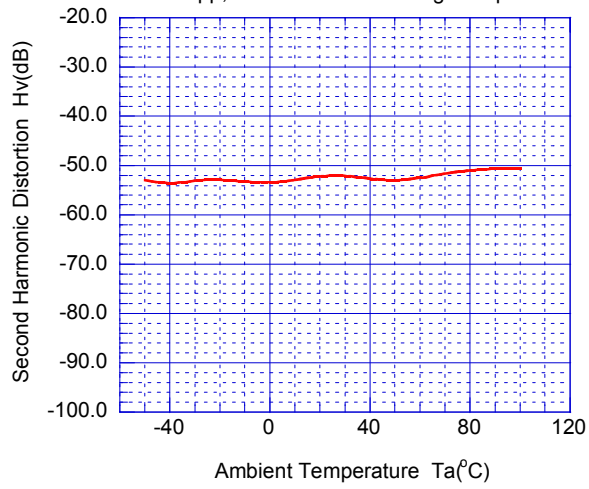

Switching Voltage vs. Temperature

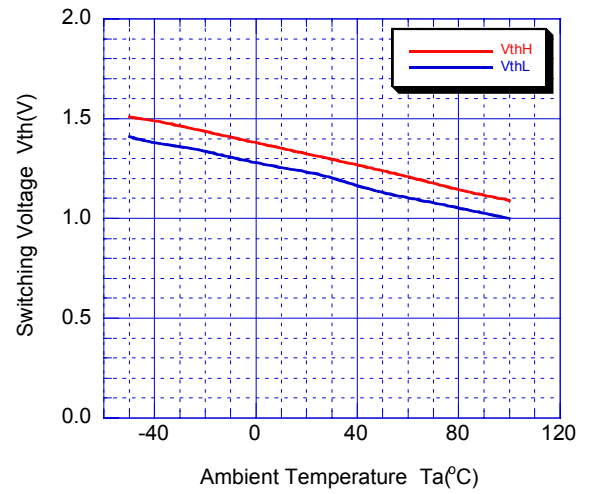

PowerSave Switching Voltage vs. Temperature

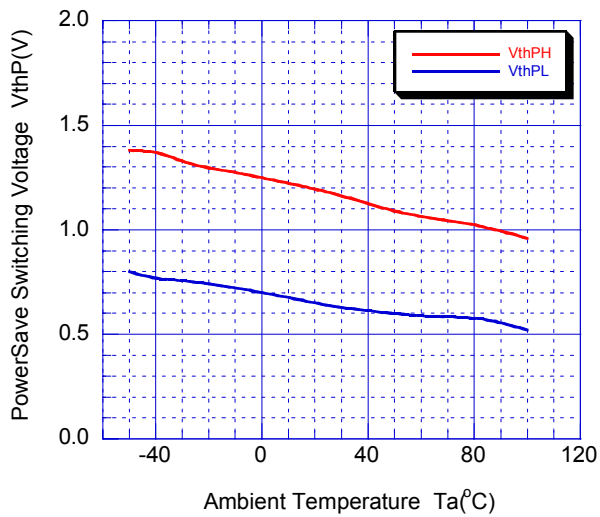

NJM2574

■ APPLICATION

When you use a power save terminal more than by 4.0V, please put resistance of about 20kΩ into a power save terminal.

In addition, power save terminal voltage (V_{thH}) -- in the case of below 4.0V, resistance is not required

Example)

● PS(V_{thH}) \geq 4.0V

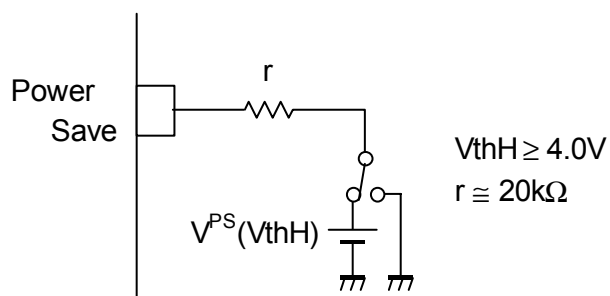

● PS(V_{thH}) < 4.0V

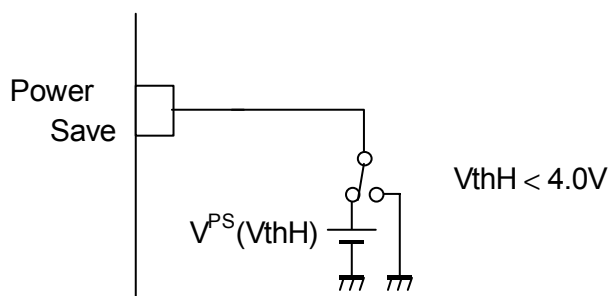

[CAUTION]
The specifications on this databook are only given for information, without any guarantee as regards either mistakes or omissions. The application circuits in this databook are described only to show representative usages of the product and not intended for the guarantee or permission of any right including the industrial rights.