

COLOR TFT SIGNAL PROCESSOR

■ GENERAL DESCRIPTION

The **NJM2529** is a color TFT signal processor.

It contains all function, like as Y/C separator circuit, color signal de-modulator, synchronous separate circuit, RGB interface, side black control circuit, and common pole driver, required by color TFT signal processing.

The **NJM2529** keeps selecting NTSC/PAL with external VCXO circuit TRAP circuit for each broadcasting.

■ PACKAGE OUTLINE

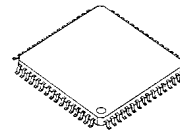

NJM2529FN1

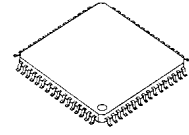

NJM2529FH1

■ FEATURES

- NTSC/PAL matching (Resemblance PAL de-modulation system)
- Internal Y/C separate circuit
- Input mode: Composite video signal, Y/C separate signal
- Internal one systems input for analog RGB
- Internal synchronous separate circuit (Liquid crystal panel PLL use)
- Internal black level insertion circuit (Use for aspect ratio change)
- Internal Gamma 2-point correction circuit
- Internal Color TFT Common Pole Driver
- Bipolar technology
- Package Outline QFP64-N1, QFP64-H1

■ BLOCK DIAGRAM

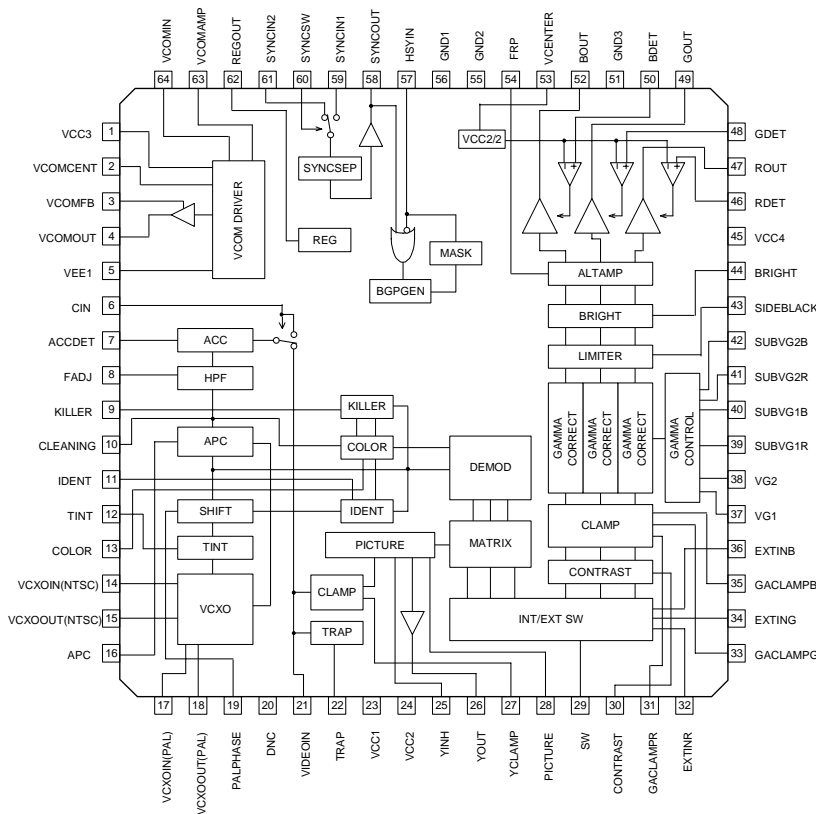

■ PIN CONFIGURATION

1 . VCC3	24.VCC2	47.ROUT
2 . VCOMCENT	25.YINH	48.GDET
3 . VCOMFB	26.YOUT	49.GOUT
4 . VCOMOUT	27.YCLAMP	50.BDET
5 . VEE1	28.PICTURE	51.GND3
6 . CIN	29.SW	52.BOUT
7 . ACCDET	30.CONTRAST	53.VCENTER
8 . FADJ	31.GACLAMP	54.FRP
9 . KILLER	32.EXTINR	55.GND2
10.CLEANING	33.GACLAMP	56.GND1
11.IDENT	34.EXTING	57.HSYIN
12.TINT	35.GACLAMP	58.SYNCOUT
13.COLOR	36.EXTINB	59.SYNCIN1
14.VCXOIN(NTSC)	37.VG1	60.SYNC
15.VCXOOUT(NTSC)	38.VG2	61.SYNCIN2
16.APC	39.SUBVG1R	62.REGOUT
17.VCXOIN(PAL)	40.SUBVG1B	63.VCOMAMP
18.VCXOOUT(PAL)	41.SUBVG2R	64.VCOMIN
19.PALPHASE	42.SUBVG2B	
20.DNC	43.SIDEBLACK	
21.VIDEOIN	44.BRIGHT	
22.TRAP	45.VCC4	
23.VCC1	46.RDET	
	47.ROUT	
	48.GDET	
	49.GOUT	
	50.BDET	
	51.GND3	
	52.BOUT	
	53.VCENTER	
	54.FRP	
	55.GND2	
	56.GND1	
	57.HSYIN	
	58.SYNCOUT	
	59.SYNCIN1	
	60.SYNC	
	61.SYNCIN2	
	62.REGOUT	
	63.VCOMAMP	
	64.VCOMIN	

■ ABSOLUTE MAXIMUM RATINGS

(Ta=25°C)

PARAMETERS	SYMBOL	RATINGS	UNIT
Supply Voltage 1	V _{CC1} - GND	8.0	V
Supply Voltage 2	V _{CC2} - GND	8.0	V
Supply Voltage 3	V _{CC3} - V _{EE1}	15.0	V
Supply Voltage 4	V _{CC4} - GND	8.0	V
Supply Voltage 5	V _{EE1} - GND	-7.0	V
Power Dissipation	P _D	QFP64-N1:700 QFP64-N1:1400 *	mW
Each Adjustment Terminal	V _{IN}	V _{CC1}	V
Sync Out Voltage	V _{SD}	V _{EE1} +V _{CC3}	V
Video Input Voltage	V _{VDIN}	3.0	V _{P-P}
External Input Voltage	EXT _{IN}	V _{CC1}	V
Analog RGB Input Signal	RGB _{IN}	V _{CC1}	V
FRP Input Signal Voltage	FRP _{IN}	V _{CC1}	V
SYNC Input Voltage	SYNC _{IN}	3.0	V _{P-P}
Operating Temperature Range	T _{opr}	-40 to +85	°C
Storage Temperature Range	T _{str}	-40 to +125	°C

*EIA/JEDEC STANDARD Test Board(76.2x114.3x1.6mm,4layers,FR-4)mounting

■ RECOMMENDED OPERATING CONDITION

(Ta=25°C)

PARAMETER	SYMBOL	TEST CONDITION	MIN.	TYP.	MAX.	UNIT
Supply Voltage Range	-	V _{CC1} - GND	4.75	5.0	5.25	V
	-	V _{CC2} - GND	V _{CC1}	5.0	5.25	V
	-	V _{CC3} - V _{EE1}	11.0	12.0	13.0	V
	-	V _{CC4} - GND	V _{CC1}	5.0	7.0	V
	-	V _{EE1} - GND	-5.25	-5.0	-4.75	V
Composite Signal Voltage	V _{IN}		0.3	0.35	0.40	V _{P-P}
Y Input Signal Voltage	Y _{IN}	Pedestal-White	0.30	0.35	0.40	V _{P-P}
C Input Signal Voltage	C _{IN}	Amplitude of Burst Signal	0.10	0.15	0.20	V _{P-P}
Analog RGB Input Signal	RGB _{IN}		0.6	0.7	0.8	V _{P-P}
SYNC Input Signal	SYNC _{IN}		0.3	1.0	1.5	V _{P-P}
HSY Input Signal	HSY _{IN}		2	-	5	V _{P-P}
TINT Adjust Voltage	TINT	NTSC	1.6	-	4.1	V
		PAL	-	0	0.3	V
Color Adjust Voltage	COLOR		0	-	5	V
BY De-mod. Axis Adjust Voltage	PALPHASE		0	-	5	V
Picture Adjust Voltage	PICTURE		0	-	5	V
Contrast Adjust Voltage	CONTRAST		1.5	-	2.8	V
Gamma 1 Adjust Voltage	VG1		1.5	-	3.5	V
Gamma 2 Adjust Voltage	VG2		1.5	-	3.8	V
Sub Gamma 1 Adjust Voltage	SUBVG1R, B		0	-	5	V
Sub Gamma 2 Adjust Voltage	SUBVG2R, B		0	-	5	V
Bright Adjust Voltage	BRIGHT		1.9	-	3.6	V
VCOM Amp Adjust Voltage	VCOMAMP		0	-	5	V
VCOM Center Adjust Voltage	VCOMCENT		0	-	5	V

(Point 1) Investigation Crosstalk level when design for depend to application.

■ ELECTRICAL CHARACTERISTICS

(Ta=25°C, V_{CC1}=5V, V_{CC2}=5V, V_{CC3}=7V, V_{CC4}=5V, V_{EE1}=-5V, TP2=TP13=TP30=TP44=TP63=2.5V, TP12=2.8V, TP29=5V, TP37=1V, TP38=3V, TP43=0V, TP60=5V, SW6=SW29=SW58=L)

PARAMETER	SYMBOL	TEST CONDITION (TP=IC Pin No.)	MIN.	TYP.	MAX.	UNIT
Operating Current 1	I _{CC1}	V _{CC1} , No signal	-	25.0	33.0	mA
Operating Current 2	I _{CC2}	V _{CC2} , No signal	-	20.0	27.0	mA
Operating Current 3	I _{CC3}	V _{CC3} , No signal, TP64=0V	-	5.8	8.7	mA
Operating Current 4	I _{CC4}	V _{CC4} , No signal	-	14.5	18.0	mA
Operating Current 5	I _{EE1}	V _{EE1} , No Signal, TP64=0V	-11.8	-7.5	-	mA
Contrast Adjust Gain Variable Range	G _{CT1}	SG1 applied to TP32, TP34 and TP36. SG10 applied to TP54, SG11 applied to TP57, SG2 applied to SYNC IN, define the each amplitude (BLK-WHT) at SW29=H, and TP30=0V, 2.5V, 5V as V1, V2 and V3.	-	-12.0	-9.0	dB
	G _{CT2}	Then measure the each output of the non-inverting $G_{CT1}=20\text{LOG}(V1/V2)$ $G_{CT2}=20\text{LOG}(V3/V2)$ Measure points are Rout, Gout, Bout.	1.0	2.5	-	
Image Quality Adjust Variable Minimum Range (Y/C)	G _{PSMIN1}	SG3 (100KHz, 1.8MHz) applied to VIDEO IN, SG10 applied to TP54, SG11 applied to TP57, SG2 applied to SYNC IN, measure amplitude on TP49 of non-inverting. The each gain on SG3 of sin signal of frequency define as G(1.8M),G(100K).	-	-2.0	2.0	dB
Image Quality Adjust Variable Maximum Range (Y/C)	G _{PSMAX1}	$G_{PSMIN1}=G(1.8M)-G(100K)$ At SW28=H, TP28=0V $G_{PSMAX1}=G(1.8M)-G(100K)$ At SW28=H, TP28=5V	5.0	7.5	-	
Image Quality Adjust Variable Minimum Range (Composite)	G _{PSMIN2}	SW6=H, TP6(B)=0V, SG3 (100KHz, 1.8MHz) applied to VIDEO IN, SG10 applied to TP54, SG11 applied to TP57, SG2 applied to SYNC IN, measure amplitude on TP49 of non-inverting.	-	-4.0	0.0	dB
Image Quality Adjust Variable Maximum Range (Composite)	G _{PSMAX2}	The each gain on SG3 of sin signal of frequency define as G(1.8M),G(100K). $G_{PSMIN2}=G(1.8M)-G(100K)$ at SW28=H, TP28=0V $G_{PSMAX1}=G(1.8M)-G(100K)$ at SW14=L, SW25=H, TP25=5V	3.0	5.5	-	
Trap attenuation (NTSC)	G _{CFNT}	SW6=H, TP6(B)=0V, SG2 applied to SYNC IN, SG11 applied to TP57, SG3 (100KHz, 3.579545MHz, 4.43361875MHz 200mVpp) applied to VIDEO IN.	-	-45	-30	dB
Trap attenuation (PAL)	G _{CFPAL}	B1, B2 define output swing of TP26 at TP12=2.8V, SG3 (3.579545MHz), SG3 (100KHz). B3, B4 define output swing of TP26 at TP12=0V, SG3 (4.43361875MHz), SG3 (100kHz). $G_{CFNT}=20*\text{LOG}(B1/B2)$ $G_{CFPAL}=20*\text{LOG}(B3/B4)$	-	-45	-30	

■ ELECTRICAL CHARACTERISTICS

($T_a=25^\circ\text{C}$, $V_{CC1}=5\text{V}$, $V_{CC2}=5\text{V}$, $V_{CC3}=7\text{V}$, $V_{CC4}=5\text{V}$, $V_{EE1}=-5\text{V}$, $TP2=TP13=TP30=TP44=TP63=2.5\text{V}$, $TP12=2.8\text{V}$, $TP29=5\text{V}$, $TP37=1\text{V}$, $TP38=3\text{V}$, $TP43=0\text{V}$, $TP60=5\text{V}$, $SW6=SW29=SW58=L$)

PARAMETER	SYMBOL	TEST CONDITION (TP=IC Pin No.)	MIN.	TYP.	MAX.	UNIT
ACC Characteristic (NTSC)	G_{A1}	SG11 applied to TP57, SG2 applied to SYNC IN, SG6 (3.579545MHz, 150mVpp typical swing) applied to TP6, Vo1, Vo2 and Vo3 define output swing of TP49 at set SG6 on 0dB, +6dB, -25dB toward 0.15Vpp. $G_{A1}=20\text{LOG}(Vo2/Vo1)$ $G_{A2}=20\text{LOG}(Vo3/Vo1)$	-	0.0	2.0	dB
	G_{A2}		-15.0	-10.0	-	
ACC Characteristic (PAL)	G_{A3}	SG11 applied to TP57, SG2 applied to SYNCIN, SG6 (4.43MHz, 150mVpp typical swing) applied to TP6, TP12=0V. Vo1, Vo2 and Vo3 define output swing of TP49 at set SG6 on 0dB, +6dB, -25dB toward 0.15Vpp. $G_{A3}=20\text{LOG}(Vo2/Vo1)$ $G_{A4}=20\text{LOG}(Vo3/Vo1)$	-	0.0	2.0	dB
	G_{A4}		-15.0	-10.0	-	
Color Control Gain Variable Range	G_{c1}	SG11 applied to TP57, SG2 applied to SYNC IN, SG6 (3.579545MHz, typical Swing 150mVpp) applied to TP6. Vo1, Vo2 and Vo3 define output swing of TP49 at TP13=0V, 2.5V, 5.0V. $G_{c1}=20\text{LOG}(Vo1/Vo2)$ $G_{c2}=20\text{LOG}(Vo3/Vo2)$	-70	-50	-40	dB
	G_{c2}		2.0	4.0	-	
APC Capture Range (Input Composite Signal, NTSC)	f_{A1}	SG11 applied to TP57, SG2 applied to SYNC IN, SG6 (3.579545MHz, 150mVpp typical swing) applied to TP6 or VIDEO IN. This item is difference between the input frequency and 3.579545 MHz at work out 2V of TP9 voltage by variable the BURST frequency. f_{A1} =when approach BURST frequency from low frequency. f_{A2} = when approach BURST frequency from high frequency at SW6=H, TP6(B)=0V, VIDEOIN=SG6 f_{A3} =when approach BURST frequency from low frequency. f_{A4} = when approach BURST frequency from high frequency at SW6=L, TP6=SG6	-	-2900	-700	Hz
	f_{A2}		+700	+1500	-	
APC Capture Range (Input Y/C Signal, NTSC)	f_{A3}		-	-2900	-700	Hz
	f_{A4}		+700	+1500	-	

■ ELECTRICAL CHARACTERISTICS

($T_a=25^{\circ}\text{C}$, $V_{CC1}=5\text{V}$, $V_{CC2}=5\text{V}$, $V_{CC3}=7\text{V}$, $V_{CC4}=5\text{V}$, $V_{EE1}=-5\text{V}$, $TP2=TP13=TP30=TP44=TP63=2.5\text{V}$, $TP12=2.8\text{V}$, $TP29=5\text{V}$, $TP37=1\text{V}$, $TP38=3\text{V}$, $TP43=0\text{V}$, $TP60=5\text{V}$, $SW6=SW29=SW58=L$)

PARAMETER	SYMBOL	TEST CONDITION (TP=IC Pin No.)	MIN.	TYP.	MAX.	UNIT
APC Capture Range (Input Composite Signal, PAL)	f_{A5}	SG11 applied to TP57, SG2 applied to SYNC IN, SG6 (4.43361875, 150mVpp typical swing) applied to TP6 or VIDEO IN. This item is Difference between the input frequency and 4.43361875 MHz at work out 2V of TP9 voltage by variable the BURST frequency. f_{A1} =when approach BURST frequency from low frequency. f_{A2} = when approach BURST frequency from high frequency at $SW6=H, TP6(B)=0V, VIDEOIN=SG6$ f_{A3} =when approach BURST frequency from low frequency. f_{A4} = when approach BURST frequency from high frequency at $SW6=H, TP6=SG6$	-	-2900	-700	Hz
	f_{A6}		+700	+1500	-	
APC Capture Range (Input Y/C Signal, PAL)	f_{A7}	SG3 (350mVpp, 3.579545MHz) applied to VIDEO IN, SG2 applied to SYNC IN, SG11 applied to TP57. $SW6=H$, TP6 (B) voltage at change Y/C to composite by raise on TP6 (B) voltage.	-	-2900	-700	Hz
	f_{A8}		+700	+1500	-	
Composite→Y/C Input Switching Voltage	V_{THCY}	SG3 (350mVpp, 3.579545MHz) applied to VIDEO IN, SG2 applied to SYNC IN, SG11 applied to TP57. $SW6=H$, TP6 (B) voltage at change Y/C to composite by raise on TP6 (B) voltage.	1.3	1.6	1.9	V
Y/C→Composite Input Switching Voltage	V_{THYC}	SG3 (350mVpp, 3.579545MHz) applied to VIDEOIN, SG2 applied to SYNC IN1, SG11 applied to TP57, SG10 applied to TP54, $SW6=H$, TP6 (B) Voltage at change composite to Y/C by drop on TP6 (B) voltage.	0.7	1.0	1.3	V
TINT Variable Range	Θ_{T1}	SG6 (3.579545MHz, 150mVpp) applied to TP6, SG2 applied to SYNC IN, SG11 applied to TP57. The Θ_1 was controlled input phase so that output swing of TP49 maximum at $TP12=1.6\text{V}$. The each Θ_2 and Θ_3 were the controlled input phase so that output swing of TP49 maximum at $TP12=2.8\text{V}$, 4.0V. $\Theta_{T1}=\Theta_2-\Theta_1$ $\Theta_{T2}=\Theta_2-\Theta_3$	+30	+45	-	deg
	Θ_{T2}		-	-45	-30	
NTSC /PAL Switching Voltage	V_{THNP}	SG6 (3.58MHz, 150mVpp) applied to TP6, SG2 applied to SYNC IN, SG11 applied to TP57. This item TP12 voltage at change from NTSC to PAL at down TP12 voltage.	0.4	0.7	1.0	V

■ ELECTRICAL CHARACTERISTICS

(Ta=25°C, V_{CC1}=5V, V_{CC2}=5V, V_{CC3}=7V, V_{CC4}=5V, V_{EE1}=-5V, TP2=TP13=TP30=TP44=TP63=2.5V, TP12=2.8V, TP29=5V, TP37=1V, TP38=3V, TP43=0V, TP60=5V, SW6=SW29=SW58=L)

PARAMETER	SYMBOL	TEST CONDITION (TP=IC Pin No.)	MIN.	TYP.	MAX.	UNIT
Color Killer Operating Input Level (NTSC)	V _{KIN1}	SG6 (3.58MHz, 150mVpp) applied to TP6, SG2 applied to SYNCIN, SG11 applied to TP57. This item measure input level at killer is tern on at decrease the input swing.	-	-42	-37	dB
Color Killer Operating Input Level (PAL)	V _{KIN2}	TP12=0V, SG2 applied to SYNCIN, SG11 applied to TP57, SG6 (4.43MHz, 150mVpp) applied To TP6. This item measure input level at killer is tern on at decrease The input swing.	-	-37	-32	
Output Level Voltage Difference among RGB	ΔVBRGB	SG2 applied to SYNC IN, SG11 applied to TP57, SW29=H, SG1 (700mVpp) applied to TP32, TP34, TP36, SG10 applied to TP54. Then VRB, VGB, and VBB define the non-invert black level of TP47, TP49, TP52. SW29=L, VRBI, VGBI, and VBBI define the invert black level of them.	-150	0	+150	mV
INT-EXT Output Black Level Voltage Difference	ΔVBIE	ΔVBRGB=VRB-VGB, VBB-VGB=VRBI-VGBI, SG4 applied to VIDEO IN. Then VRB (Y), VGB (Y), and VBB (Y) defines the non-inverting black level of TP47, TP49, and TP52. VRBI (Y), VGBI(Y), and VBBI (Y) define the invert black level of them. VBIE=VRB-VRB (Y), VGB-VGB (Y), =VBB-VBB (Y), VRBI-VRBI(Y), =VGBI-VGBI(Y), VBBI-VBBI(Y)	-150	0	+150	mV
Gain Difference Between Invert And Non-invert	ΔGINV	SG2 applied to SYNC IN, SG11 Applied to TP57, SW29=H, SG1 (700mVpp) applied to TP32, TP34, TP36, SG10 applied TP54. This item measure the signal swing (BLK-WHT) of TP47, TP49, TP52. VRG, VGG, VBG define the non-inverting side of them. VRGI, VGGI, VBGI define the invert side of them. SW29=L, SG4 applied VIDEO IN.	-0.6	0	+0.6	dB
Gain Difference Among RGB	ΔGRGB	This item measure the signal swing (BLK-WHT) of TP47, TP49, TP52. VYRG, VYGG, VYBG define the non-inverting side of them. ΔGINV =20LOG(VRGI/VRG) =20LOG(VGGI/VGG) =20LOG(VBGI/VBG)	-0.6	0	+0.6	
INT-EXT Gain Difference	ΔGIE	ΔVRGB =20LOG(VRG/VGG) =20LOG(VGG/VBG) =20LOG(VBG/VRG) ΔGIE =20LOG(VRG/VYRG) =20LOG(VGG/VYGG) =20LOG(VBG/VYBG)	-0.6	0	+0.6	

■ ELECTRICAL CHARACTERISTICS

(Ta=25°C, V_{CC1}=5V, V_{CC2}=5V, V_{CC3}=7V, V_{CC4}=5V, V_{EE1}=-5V, TP2=TP13=TP30=TP44=TP63=2.5V, TP12=2.8V, TP29=5V, TP37=1V, TP38=3V, TP43=0V, TP60=5V, SW6=SW29=SW58=L)

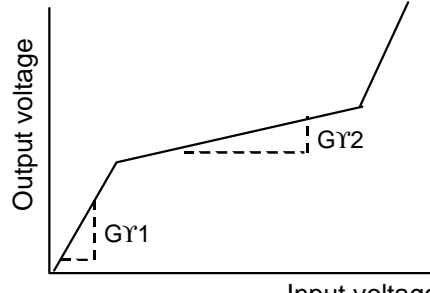
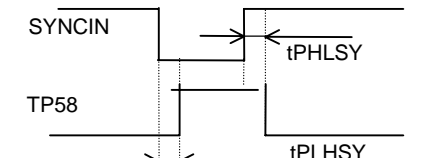
PARAMETER	SYMBOL	TEST CONDITION (TP=IC Pin No.)	MIN.	TYP.	MAX.	UNIT
FRP Input Threshold Voltage	V _{THFRP}	SG2 applied to SYNC IN, SG11 Applied to TP57, SW29=H, SG1 applied to TP34. This item define TP54 voltage at invert output of TP49 at increase TP54 voltage.	1.2	1.5	1.8	V
Interface Frequency as Characteristic	f _{INT}	SG2 applied to SYNC IN, SG11 applied to TP57, SW29=H, SG5 (100kHz) applied to TP34. Sine wave of non-invert output signal of TP49 is input signal frequency at -3dB Toward swing of 100kHz at variable frequency of SG5.	5.0	6.5	-	MHz
EXTRGB Input Threshold Voltage	V _{THEXH}	Switching Voltage of TP29 V _{THEXH} =ON Level Voltage	2.0	-	-	V
	V _{THEXL}	Switching Voltage of TP29 V _{THEXL} =OFF Level Voltage	-	-	0.8	
Gamma Characteristic	G _{γ1}	SG2 applied to SYNC IN, SG11 applied to TP57, SW29=H, SG10 applied to TP54 SG7(350mVpp) applied to TP32, TP34, TP36. This item measure the slope on TP47, TP49, and TP52 at TP37=1.8V, TP38=3.0V. 	19.0	23.0	27.0	dB
	G _{γ2}		7.5	11.5	15.5	
Synchronous Separate Input Sensitivity Current	IIS	Current flow from SYNC IN. Then measure current at TP58 change from High to Low.	-	21	30	μA
Synchronous Separate Output ON Voltage	VON	SG2 applied to SYNC IN. Then Measure output signal level voltage of TP58.	-	0.2	0.5	V
Leak Current at Synchronous Separate Output OFF	ISL	Current 40uA flow from SYNC IN. Then measure current of sink to TP58 at TP58=5V.	-	-	1.0	μA
Synchronous Separate Output Delay 1	tPHLSY	SG2 applied to SYNC IN. Then Measure time difference of 50% swing level of SYNCIN and TP58 	-	0.3	-	μs
Synchronous Separate Output Delay 2	tPLHSY		-	0.4	-	

■ ELECTRICAL CHARACTERISTICS

(Ta=25°C, V_{CC1}=5V, V_{CC2}=5V, V_{CC3}=7V, V_{CC4}=5V, V_{EE1}=-5V, TP2=TP13=TP30=TP44=TP63=2.5V, TP12=2.8V, TP29=5V, TP37=1V, TP38=3V, TP43=0V, TP60=5V, SW6=SW29=SW58=L)

PARAMETER	SYMBOL	TEST CONDITION (TP=IC Pin No.)	MIN.	TYP.	MAX.	UNIT
Synchronous Separate Output Turn OFF Time	ttHL	SG2 applied to SYNC IN. Then measure time difference of 20% to 80% swing level of TP58.	-	0.2	-	μs
Synchronous Separate Output Turn OFF Time	ttLH		-	0.2	-	
External Synchronous Input Timing 1	t1	<p>Sync Separate Output</p> <p>External Sync Input</p>	3.0	-	-	μs
External Synchronous Input Timing 2	t2		2.0	-	-	
External Synchronous Input Timing 3	t3		1.6	2.0	2.4	
RGB Output Delay Time 1	tPHL1	SG2 applied to SYNC IN, SG11 applied to TP57, SW29=H, SG10 applied to TP54, SG8 (0.35Vpp) applied to TP32, TP34, TP36. Then measure time difference of 50% swing level of TP32 and TP47, TP34 and TP49, TP36 and TP52 tPHL1=turn ON tPHL2=turn OFF	-	0.1	-	μs
RGB Output Delay Time 2	tPHL2		-	0.1	-	
Crosstalk Among RGB	CTRGB1	SG2 applied to SYNC IN, SG11 applied to TP57, SW29=5V, TP29=5V, TP54=5V, TP34= TP36=GND, SG5 (1MHz, 700mVpp) applied to TP32. Measure the output of 1MHz component on TP47, TP49 and TP52. Calculate the swing ratio of TP49, TP52 toward TP47.	-	-50	-40	dB
	CTRGB2	SG2 applied to SYNC IN, SG11 applied to TP57, SW29=5V, TP29=5V, TP54=5V, TP32=TP36=GND, SG5 (1MHz, 700mVpp) applied to TP34. Measure the output of 1MHz component on TP47, TP49 and TP52. Calculate the swing ratio of TP47, TP52 toward TP49.	-	-50	-40	
	CTRGB3	SG2 applied to SYNC IN, SG11 applied to TP57, SW29=5V, TP29=5V, TP54=5V, TP32=TP34=GND, SG5 (1MHz, 700mVpp) applied to TP36. Measure the output of 1MHz component on TP47, TP49 and TP52. Calculate the swing ratio of TP47, TP49 toward TP52.	-	-50	-40	

■ ELECTRICAL CHARACTERISTICS

(Ta=25°C, V_{CC1}=5V, V_{CC2}=5V, V_{CC3}=7V, V_{CC4}=5V, V_{EE1}=-5V, TP2=TP13=TP30=TP44=TP63=2.5V, TP12=2.8V, TP29=5V, TP37=1V, TP38=3V, TP43=0V, TP60=5V, SW6=SW29=SW58=L)

PARAMETER	SYMBOL	TEST CONDITION (TP=IC Pin No.)	MIN.	TYP.	MAX.	UNIT
Crosstalk 1 Between SW (EXT→INT)	CTERINT	SG2 applied to SYNCIN, SG11 applied to TP57, SW29=5V, TP54=5V, SG5 (1MHz, 700mVpp) applied to TP32, VIDEOIN=GND. Measure the output of 1MHz component on TP47. Calculate the swing ratio of TP29=5V, 0V.	-	-50	-35	dB
	CTEGINT	SG2 applied to SYNCIN, SG11 applied to TP57, SW29=5V, TP54=5V, SG5 (1MHz, 700mVpp) applied To TP34, VIDEOIN =GND. Measure the output of 1MHz component on TP49. Calculate the swing ratio of TP29=5V, 0V.	-	-50	-35	
	CTEBINT	SG2 applied to SYNCIN, SG11 applied to TP57, SW29=5V, TP54=5V, SG5 (1MHz, 700mVpp) applied To TP36, VIDEOIN =GND. Measure the output of 1MHz component on TP52. Calculate the swing ratio of TP29=5V, 0V.	-	-50	-35	
Crosstalk 2 Between SW (INT→EXT)	CTIE1R	SG2 applied to SYNCIN, SG11 applied to TP57, SW29=5V, TP54=5V, SG3 (1MHz, 350mVpp) applied to VIDEOIN, TP32=GND. Measure the output of 1MHz component on TP47. Calculate the swing ratio of TP29=5V, 0V.	-	-50	-35	dB
	CTIE1G	SG2 applied to SYNCIN, SG11 applied to TP57, SW29=5V, TP54=5V, SG3 (1MHz, 350mVpp) applied To VIDEOIN, TP34=GND. Measure the output of 1MHz component on TP49. Calculate the swing ratio of TP29=5V, 0V.	-	-50	-35	
	CTIE1B	SG2 applied to SYNCIN, SG11 applied to TP57, SW29=5V, TP54=5V, SG3 (1MHz, 350mVpp) applied To VIDEOIN, TP36=GND. Measure the output of 1MHz component on TP52. Calculate the swing ratio of TP29=5V, 0V.	-	-50	-35	

■ ELECTRICAL CHARACTERISTICS

(Ta=25°C, V_{CC1}=5V, V_{CC2}=5V, V_{CC3}=7V, V_{CC4}=5V, V_{EE1}=-5V, TP2=TP13=TP30=TP44=TP63=2.5V, TP12=2.8V, TP29=5V, TP37=1V, TP38=3V, TP43=0V, TP60=5V, SW6=SW29=SW58=L)

PARAMETER	SYMBOL	TEST CONDITION (TP=IC Pin No.)	MIN.	TYP.	MAX.	UNIT
Side-black Level	V _{SB}	SG2 applied to SYNCIN, SG11 applied to TP57, SW29=H, SG10 applied to TP54. When TP43=5V, define the non-invert black level of TP47, TP49, TP52 as VRB, VGB, VBB. When TP43=5V, define the invert black level of TP47, TP49, TP52 as VRBI, VGBI, VBBI. When TP43=0V, define the non-invert black level of TP47, TP49, TP52 as VRB (B), VGB (B), VBB (B). When TP43=0V, define the invert black level of TP47, TP49, TP52 as VRBI(B), VGBI (B), VBBI (B). V _{SB} =VRB-VRB (B), VGB-VGB (B), VBB-VBB (B) =VRBI (B)-VRBI, VGBI (B)-VGBI, VBBI (B)-VBBI	-	500	-	mV
VCOM Output Slew Rate	SRVCOM	SG9 applied to TP64. Measure the turn on and turn off time at 20% to 80% on TP3 output wave. Then convert to slew rate.	4.0	9.0	-	V/μs
VCOM Center Voltage	VCVCOM	SG9 applied to TP4. Measure the center voltage of TP3 output voltage.	0.9	1.2	1.5	V
VCOM Swing	VAVCOM	SG9 applied to TP64. Measure the output swing on TP6.	6.0	6.5	7.0	V _{P-P}
Delay Between Y-C	ΔT _{dYC}	Delay time of Y signal and C signal at TP49.	-	0	-	ns
RGB Slew Rate	SR _{RGB}	SG2 applied to SYNCIN. SG11 applied to TP57. SW29=H, SG8 applied to TP32, TP34, TP36. SYNCIN=SG2. Measure the turn on and turn off time at 20% to 80% of output wave on TP47, TP49, TP52. Then convert to slew rate.	9	22	40	V/μs
Demodulation Relativity Swing (R-Y/B-Y)	$\frac{R-Y}{B-Y}$	SG6 (3.58MHz, 150mVpp) applied to TP6, SG10 applied to TP54, SG2 applied to SYNCIN1, SG11 applied to TP57. TP37=1.5V, TP38=3.0V, vary the chroma phase on SG6, define non-inverting maximum output swing of TP47, TP49, SYNC IN as VR, VG, VB. (R-Y)/(B-Y)=VR/VB (G-Y)/(B-Y)=VG/VB	-	0.65	-	-
Demodulation Relativity Swing (G-Y/B-Y)	$\frac{G-Y}{B-Y}$		-	0.45	-	

■ ELECTRICAL CHARACTERISTICS

(Ta=25°C, V_{CC1}=5V, V_{CC2}=5V, V_{CC3}=7V, V_{CC4}=5V, V_{EE1}=-5V, TP2=TP13=TP30=TP44=TP63=2.5V, TP12=2.8V, TP29=5V, TP37=1V, TP38=3V, TP43=0V, TP60=5V, SW6=SW29=SW58=L)

PARAMETER	SYMBOL	TEST CONDITION (TP=IC Pin No.)	MIN.	TYP.	MAX.	UNIT
Demodulation Relativity Phase (R-Y/B-Y)	∅RB	SG6 (3.58MHz, 150mVpp) applied to TP6, SG10 applied to TP54, SG2 applied to SYNCIN, SG11 applied to TP57. TP37=1.5V, TP38=3.0V, vary the chroma phase on SG6, define the phase at maximum output amplitude of TP47, TP49, TP52 as ∅R, ∅G, ∅B. ∅RB=∅R-∅B ∅GB=∅G-∅B	-	90	-	deg
Demodulation Relativity Phase (G-Y/B-Y)	∅GB		-	240	-	
Demodulation Output residual Carrier	VCR	SG6 (3.58MHz, 150mVpp) applied to TP6, DC5V applied to TP54, SG2 Applied to SYNCIN, SG11 applied to TP57, adjust the chroma phase on SG6 for maximum the amplitude of TP52. Measure the ratio of 7.159059MHz component to the 15.734kHz component.	-	-40	-	dB

APPLICATION CIRCUIT EXAMPLE (NTSC/PAL)

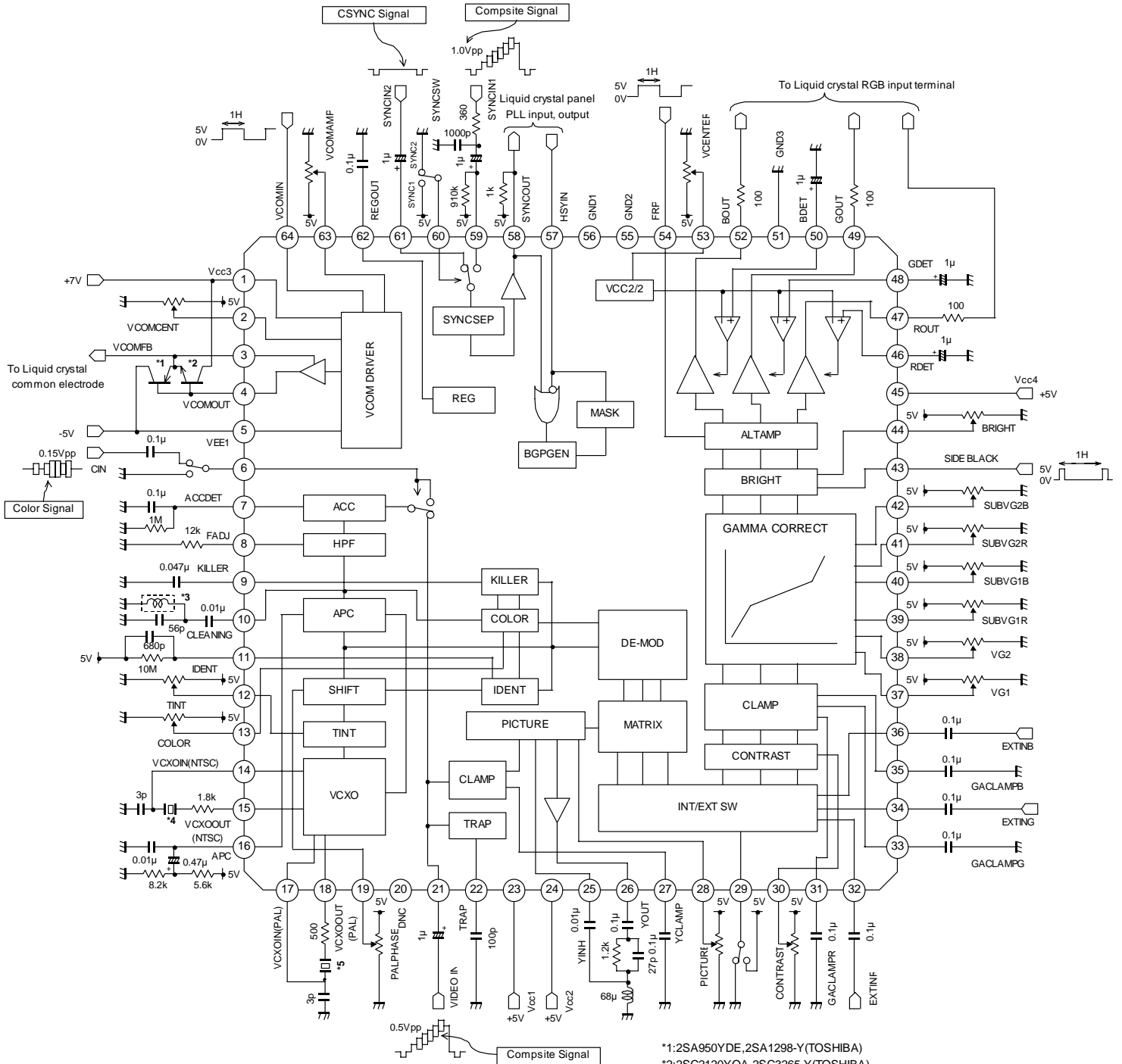

*1:2SA950YDE,2SA1298-Y(TOSHIBA)
 *2:2SC2120Y OA,2SC3265-Y(TOSHIBA)
 *3:332PN-2636BS(TOKO)
 *4:3.579545MHz Xtal DSX151GA(DAISINKU)

APPLICATION CIRCUIT EXAMPLE (NTSC)

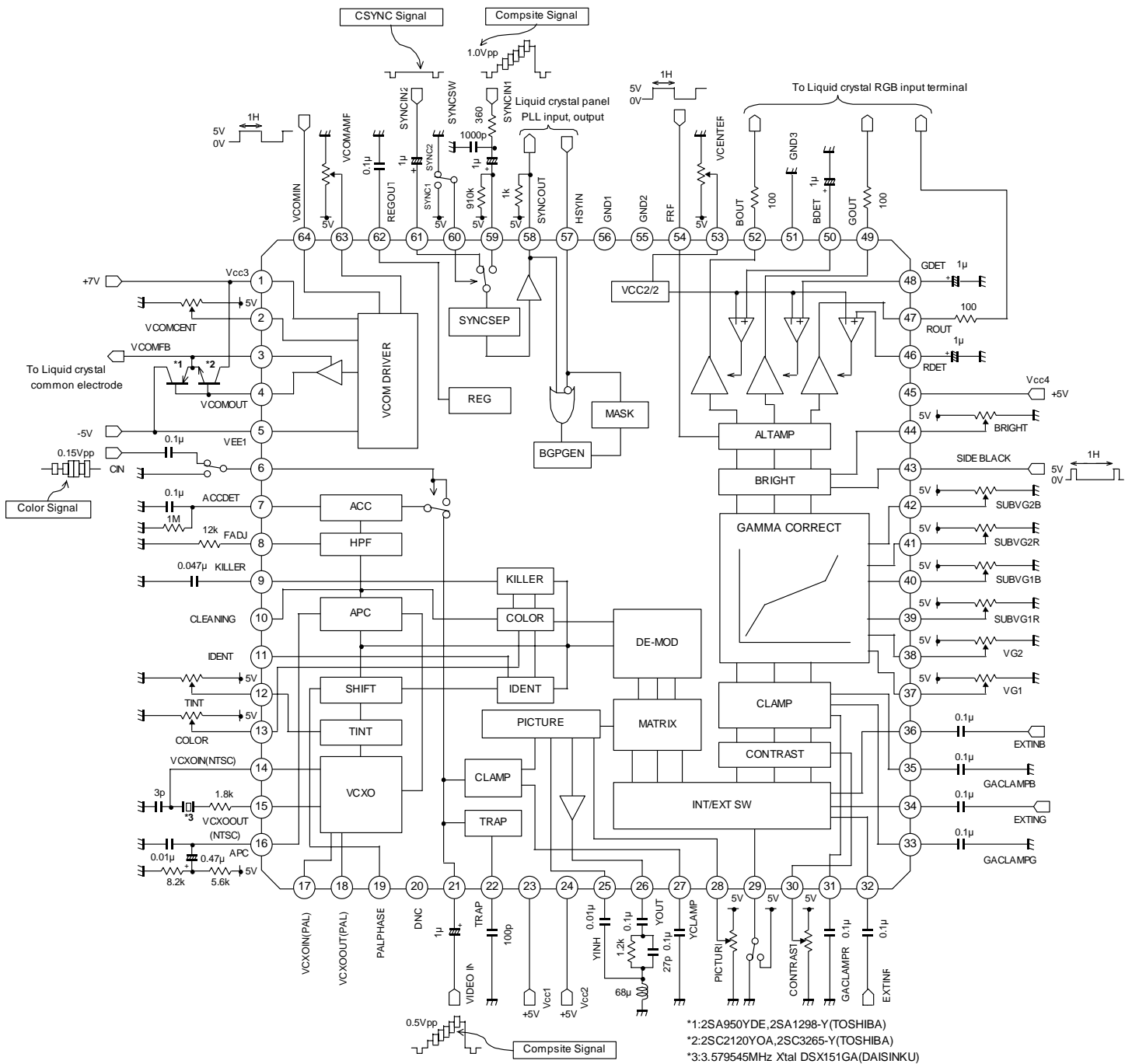

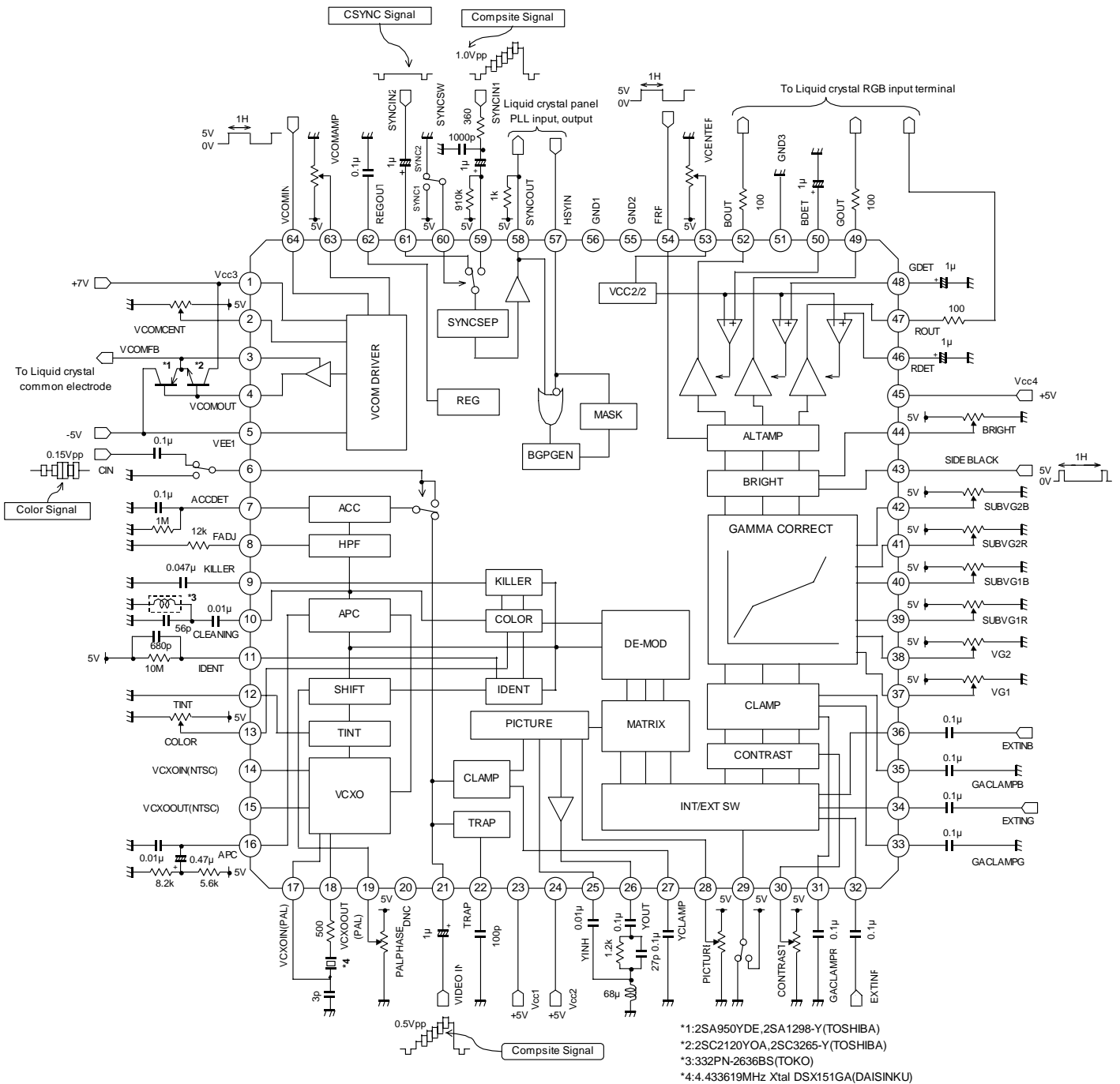

APPLICATION CIRCUIT EXAMPLE (PAL)

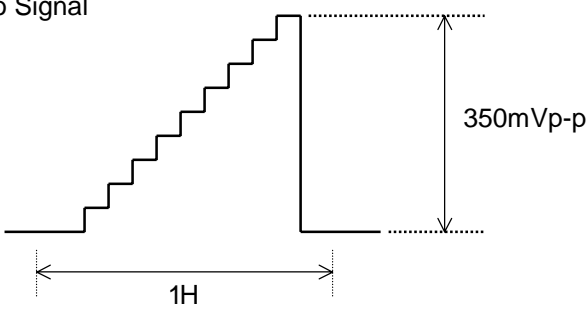
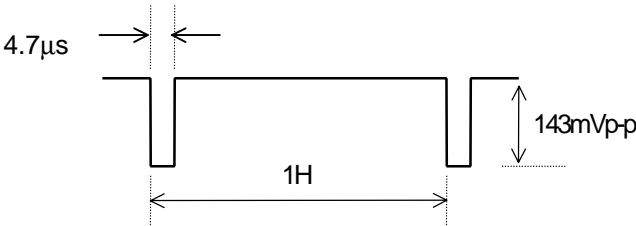
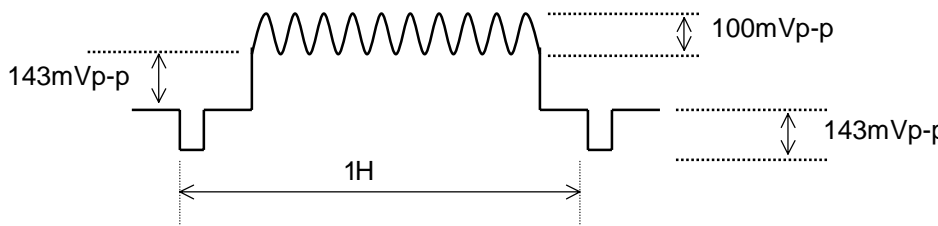
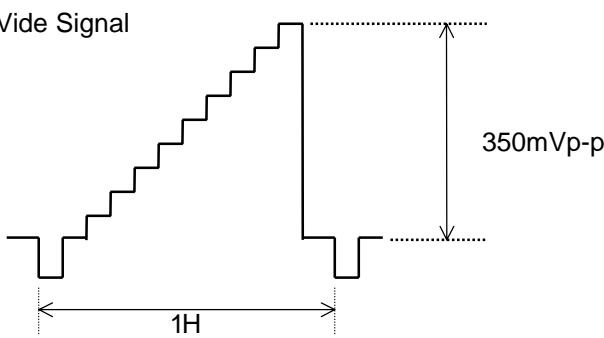

■ INPUT SIGNAL

SYMBOL	INPUT SIGNAL
SG1	<p>No Sync 10 Step Video Signal</p> 
SG2	<p>Composite Y Signal with Sync signal or 10 STEP Signal</p> 
SG3	<p>Sine Video Signal with Sync</p> 
SG4	<p>10STEP Vide Signal</p> 

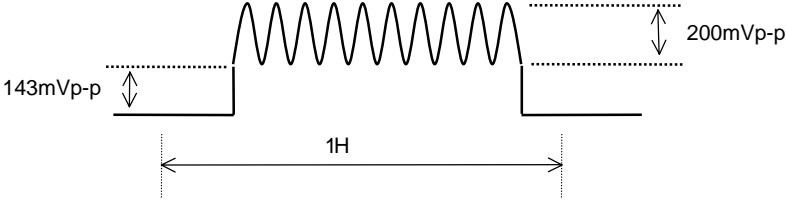
■ INPUT SIGNAL

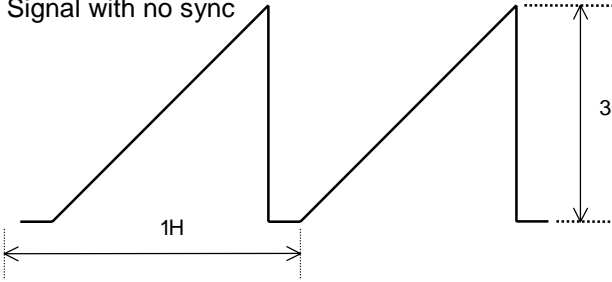
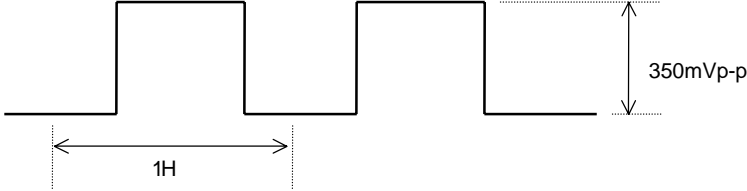
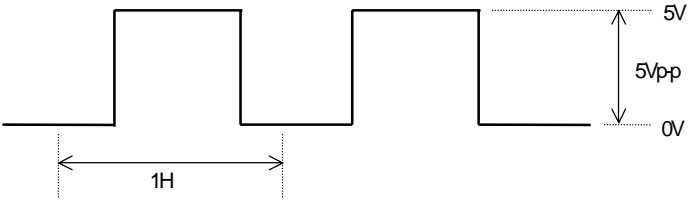
SYMBOL	INPUT SIGNAL
SG5	<p>Sine Video Signal with No sync</p>  <p>143mVp-p</p> <p>1H</p> <p>200mVp-p</p>
SG6	<p>C Signal</p>  <p>Burst Swing = 150mVp-p</p> <p>Chroma Swing = 150mVp-p</p>
SG7	<p>Ramp Video Signal with no sync</p>  <p>1H</p> <p>350mVp-p</p>
SG8	<p>Turn ON, Turn OFF Video Signal under 50ns</p>  <p>1H</p> <p>350mVp-p</p>
SG9	<p>Turn ON, Turn OFF Signal under 50ns</p>  <p>1H</p> <p>5V</p> <p>5Vpp</p> <p>0V</p>

INPUT SIGNAL

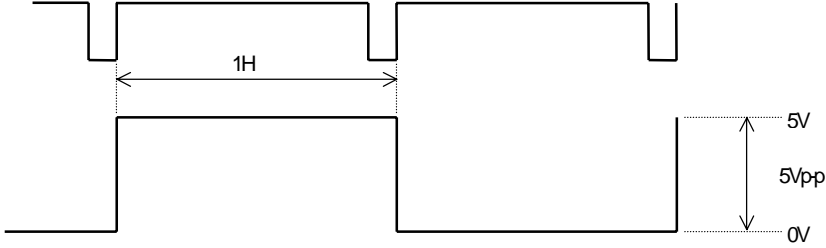
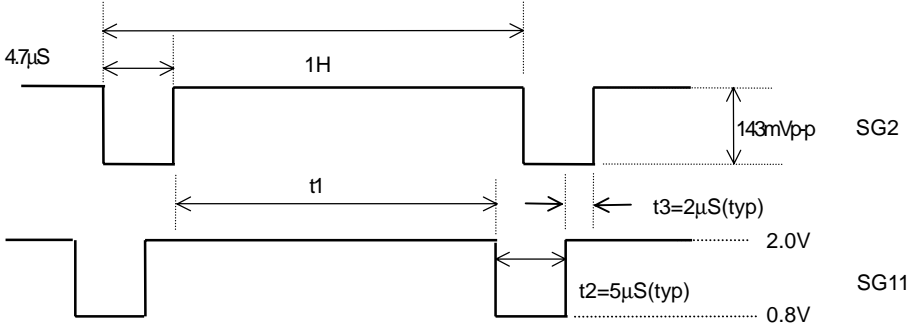
SYMBOL	INPUT SIGNAL
<p>SG10</p>	<p>FRP Signal of inverting Every 1H</p>  <p>The diagram shows two waveforms. The top waveform is a square wave with a period of 1H. The bottom waveform is an inverted square wave with the same period. The amplitude of the bottom waveform is indicated as 5Vpp, with levels at 5V and 0V.</p>
<p>SG11</p>	<p>Horizontal Sync. Signal Synchronous to SG2</p>  <p>The diagram shows two waveforms, SG2 and SG11, which are horizontal sync signals. SG2 has a period of 1H and a peak-to-peak amplitude of 143mVpp. The leading edge of SG2 has a delay of 4.7μS. SG11 has a period of 1H and a peak-to-peak amplitude of 0.8V. The leading edge of SG11 has a delay of t2 = 5μS (typ). The trailing edge of SG11 has a delay of t3 = 2μS (typ). The period of SG11 is labeled as t1.</p>

■ EQUIVALENT CIRCUIT

PI N NO.	SYMBOL	FUNCTION	INSIDE EQUIVALENT CIRCUIT
1	VCC3	Supply to VCOM voltage. Connect to +7V supply.	
2	VCOM CENT	Adjust the center of VCOM voltage. Adjustable range: $VCOMCENT=1.2V \pm 1.5V.$	
3	VCOM FB	VCOM feedback signal. Input the feedback signal (VCOMOUT) through the discrete transistor buffer.	
4	VCOM OUT	VCOM signal output. Drive the common by connect discrete Transistor.	

■ EQUIVALENT CIRCUIT

PI N NO.	SYMBOL	FUNCTION	INSIDE EQUIVALENT CIRCUIT
5	VEE1	Connect -5V supply at lowest voltage.	
6	CIN	Chroma signal input, 150mV _{P-P} CIN=GND: Composite input mode	
7	ACC DET	Connect to ACC filter.	
8	FADJ	Adjust the frequency with internal filter.	

■ EQUIVALENT CIRCUIT

PI N NO.	SYMBOL	FUNCTION	INSIDE EQUIVALENT CIRCUIT
9	KILLER	Connect to the color killer filter.	
10	CLEANING	Connect to the burst cleaning coil at PAL selection. NTSC selection:open	
11	IDENT	Connect to the ident filter at PAL selection. NTSC selection:open	
12	TINT	Adjust Hue signal. Adjustable Hue range:±45deg to control DC supply. TINT=GND:PAL mode =High:NTSC mode	

■ EQUIVALENT CIRCUIT

PI N NO.	SYMBOL	FUNCTION	INSIDE EQUIVALENT CIRCUIT
13	COLOR	Adjust color. Adjust the tint color by input voltage.	
14	VCXOIN (NTSC)	VCXO input at NTSC.	
15	VCXO OUT (NTSC)	VCXO output at NTSC.	
16	APC	Connect to the APC detector filter.	

■ EQUIVALENT CIRCUIT

PI N NO.	SYMBOL	FUNCTION	INSIDE EQUIVALENT CIRCUIT
17	VCXOIN (PAL)	VCXO input at PAL.	
18	VCXO OUT (PAL)	VCXO output at PAL.	
19	PAL PHASE	Adjust the BY de-modulator axis. Adjust the de-modulation angle to 90 degree at PAL. NTSC selection:open	
20	DNC	DNC pin.(OPEN only)	

■ EQUIVALENT CIRCUIT

PI N NO.	SYMBOL	FUNCTION	INSIDE EQUIVALENT CIRCUIT
21	VIDEO IN	Composite video signal / Y-signal input. CIN (6pin) =GND:Composite input mode.	
22	TRAP	Connect to the ceramic condenser (100pF) or TRAP filter for Y/C separate.	
23	VCC1	Supply voltage,+5V Connect 23 pin, 24 pin to the same potential.	
24	VCC2	Supply voltage,+5V Connect 23 pin, 24 pin to the same potential.	

■ EQUIVALENT CIRCUIT

PI N NO.	SYMBOL	FUNCTION	INSIDE EQUIVALENT CIRCUIT
25	YINH	Y-signal input of high frequency division.	
26	YOUT	Y-signal output. Connect to the second differential filter.	
27	YCLAMP	Connect to the CLAMP capacitor for Y-signal. Leakless capacitor for use.	
28	PICTURE	Adjust the frequency of Y-signal for revise outline of Y-signal. Emphasize outline, when voltage increase.	

■ EQUIVALENT CIRCUIT

PI N NO.	SYMBOL	FUNCTION	INSIDE EQUIVALENT CIRCUIT						
29	SW	<p>Select the internal/external signal. SW=Low:Internal signal mode High:External signal mode</p> <table border="1" style="margin-left: auto; margin-right: auto;"> <tr> <td>SW</td> <td>OUT</td> </tr> <tr> <td>L</td> <td>INT</td> </tr> <tr> <td>H</td> <td>EXT</td> </tr> </table>	SW	OUT	L	INT	H	EXT	
SW	OUT								
L	INT								
H	EXT								
30	CONTRAST	<p>Adjust the gain of RGB signal. Adjust the RGB signal range by CONTRAST input voltage.</p>							
31	GA CLAMPR	<p>Connect to the CLAMP pedestal level of R signal. Leakless capacitor for use.</p>							
32	EXTINR	<p>External R(RGB) signal input, 700mV_{p-p} and source color signal</p>							

■ EQUIVALENT CIRCUIT

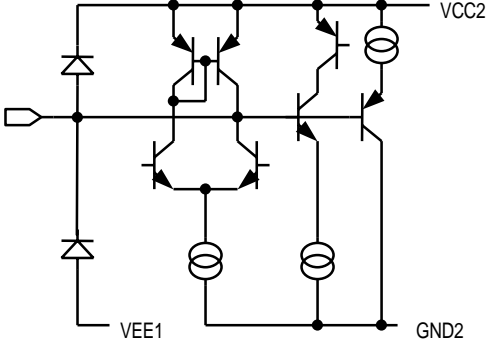
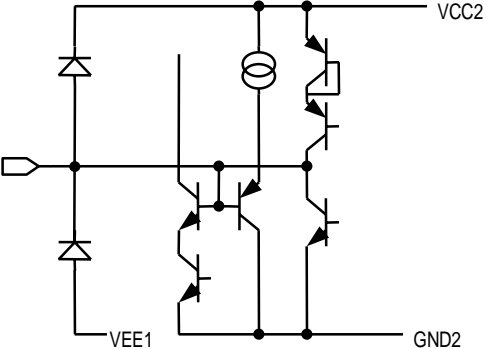
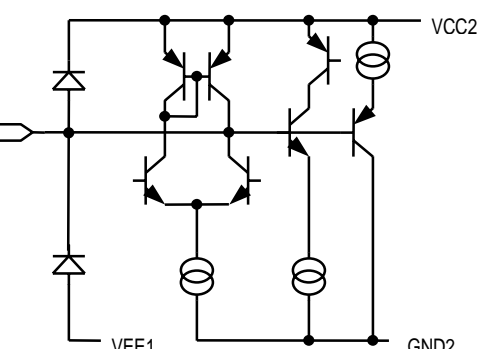
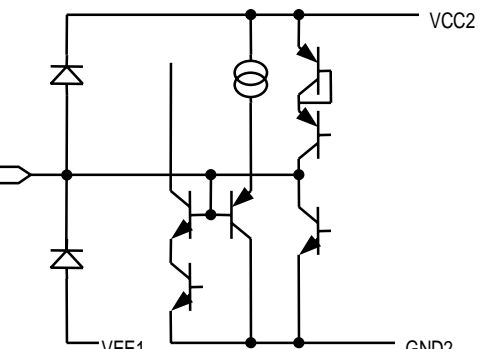
PI N NO.	SYMBOL	FUNCTION	INSIDE EQUIVALENT CIRCUIT
33	GA CLAMPG	Connect to the CLAMP pedestal level of G signal. Leakless capacitor for use.	
34	EXTING	External G(RGB) signal input, 700mV _{P-P} and source color signal.	
35	GA CLAMPB	Connect to the CLAMP pedestal level of B signal. Leakless capacitor for use.	
36	EXTINB	External B(RGB) signal input, 700mV _{P-P} and source color signal.	

■ EQUIVALENT CIRCUIT

PI N NO.	SYMBOL	FUNCTION	INSIDE EQUIVALENT CIRCUIT
37	VG1	Adjust the first point of low side in RGB γ characteristic. Pre-set and controlled RGB together.	
38	VG2	Adjust the first point of high side in RGB γ characteristic. Pre-set and controlled RGB together.	
39	SUBVG1R	Adjust the second point of low side in R signal γ characteristic. Pre-set and not controlled RGB together, adjust the R signal only.	
40	SUBVG1B	Adjust the second point of low side in B signal γ characteristic. Pre-set and not controlled RGB together, adjust the B signal only.	

■ EQUIVALENT CIRCUIT

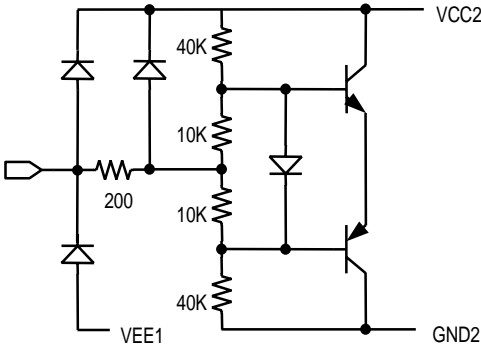
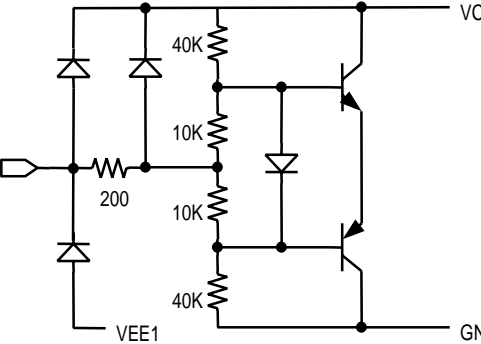
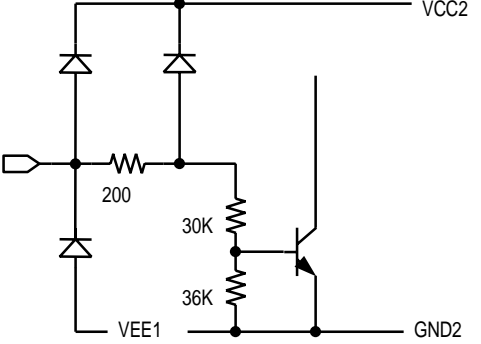
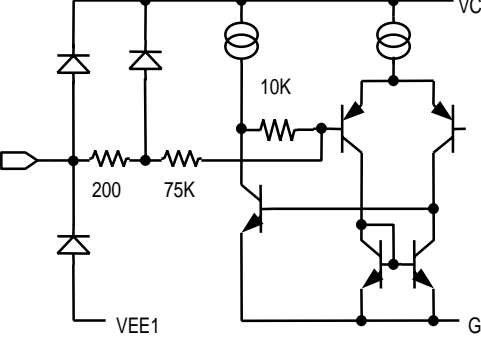
PI N NO.	SYMBOL	FUNCTION	INSIDE EQUIVALENT CIRCUIT
41	SUBVG2R	Adjust the second point of high side in R signal γ characteristic. Pre-set and not controlled RGB together, adjust the R signal only.	
42	SUBVG2B	Adjust the second point of high side in B signal γ characteristic. Pre-set and not controlled RGB together, adjust the B signal only.	
43	SIDE BLACK	Control signal input with both black side of monitor, when aspect ratio change 4:3 and 16:9. SIDEBLACK=High:Black level SIDEBLACK=Low or OPEN:Through RGB signal is controlled together.	
44	BRIGHT	Adjust the bright of RGB signal, controlled black level	

■ EQUIVALENT CIRCUIT

PI N NO.	SYMBOL	FUNCTION	INSIDE EQUIVALENT CIRCUIT
45	VCC4	Supply voltage, +5V $VCC4 \geq VCC1, VCC2$	
46	RDET	Connect to the capacitor for R signal center modulator. Leakless capacitor for use.	
47	ROUT	R signal output.	
48	GDET	Connect to the capacitor for G signal center modulator. Leakless capacitor for use.	

■ EQUIVALENT CIRCUIT

PI N NO.	SYMBOL	FUNCTION	INSIDE EQUIVALENT CIRCUIT
49	GOUT	G signal output.	
50	BDET	Connect to the capacitor for B signal center modulator. Leakless capacitor for use.	
51	GND3	Connect to GND. (RGB output)	
52	BOUT	B signal output.	

■ EQUIVALENT CIRCUIT

PIN NO.	SYMBOL	FUNCTION	INSIDE EQUIVALENT CIRCUIT
53	VCENTER	Input the center voltage of RGB output signal.(Vcc2/2 preset)	
54	FRP	Connect to the polarity reversal pulse of RGB output signal. Input: 5V _{P-P}	
55	GND2	Connect to GND.	
56	GND1	Connect to GND.	

■ EQUIVALENT CIRCUIT

PI N NO.	SYMBOL	FUNCTION	INSIDE EQUIVALENT CIRCUIT						
57	HSYIN	Connect to the outside synchronous. Fripfrop reverse with the start of synchronous signal at PAL.							
58	SYNCOUT	Composite synchronous signal output, non-inverting and open collector.							
59	SYNCIN1	Synchronous signal input, synchronize with RGBOUT. Input level is 2Vp-p maximum, and can input include Y-signal and composite video signal.							
60	SYNC SW	Select to the SYNCIN1/SYNCIN2. <table border="1" style="margin: 10px auto;"> <thead> <tr> <th>SYNC SW</th> <th>OUTPUT</th> </tr> </thead> <tbody> <tr> <td>H</td> <td>SYNCIN1</td> </tr> <tr> <td>L</td> <td>SYNCIN2</td> </tr> </tbody> </table>	SYNC SW	OUTPUT	H	SYNCIN1	L	SYNCIN2	
SYNC SW	OUTPUT								
H	SYNCIN1								
L	SYNCIN2								

■ EQUIVALENT CIRCUIT

PI N NO.	SYMBOL	FUNCTION	INSIDE EQUIVALENT CIRCUIT
61	SYNCIN2	Synchronous signal input, synchronize with RGBOUT. Input level is 2Vp-p maximum, and can input include Y-signal and composite video signal.	
62	REGOUT	Regulator output, connect to decoupling capacitor internal use only.	
63	VCOMAMP	Adjust the VCOM signal level. Adjustable range: VCOM=6.5V ± 2.0V	
64	VCOMIN	VCOM 5Vp-p signal input.	

■ PIN FUNCTION at NO USE

No	SYMBOL	FUNCTION	No	SYMBOL	FUNCTION
1	VCC3	OPEN: when do not use VCOM	33	GACLAMPG	Connect to clamp capacitor
2	VCOMCENT	OPEN	34	EXTING	OPEN
3	VCOMFB	OPEN	35	GACLAMPB	Connect to clamp capacitor
4	VCOMOUT	OPEN	36	EXTINB	OPEN
5	VEE1	GND: when do not use VCOM	37	VG1	Input fixed DC voltage
6	CIN	GND: when composite signal input OPEN: other	38	VG2	Input fixed DC voltage
7	ACCDDET	OPEN	39	SUBVG1R	OPEN
8	FADJ	Connect with 12K Ω	40	SUBVG1B	OPEN
9	KILLER	OPEN	41	SUBVG2R	OPEN
10	CLEANING	OPEN	42	SUBVG2B	OPEN
11	IDENT	OPEN	43	SIDEBLACK	OPEN
12	TINT	NTSC MODE: 1.6V or higher voltage PAL MODE: GND	44	BRIGHT	Input fixed DC voltage
13	COLOR	OPEN	45	VCC4	Supply voltage (+5V, \geq VCC1)
14	VCXOIN (NTSC)	OPEN	46	RDET	Connect to capacitor for demodulate R signal
15	VCXOOUT (NTSC)	OPEN	47	ROUT	OPEN
16	APC	OPEN	48	GDET	Connect to capacitor for demodulate G signal
17	VCXOIN (PAL)	OPEN	49	GOUT	OPEN
18	VCXOOUT (PAL)	OPEN	50	BDET	Connect to capacitor for demodulate G signal
19	PALPHASE	OPEN	51	GND3	GND
20	DNC	OPEN only	52	BOUT	OPEN
21	VIDEOIN	Connect with 0.01 μ F to GND	53	VCENTER	OPEN
22	TRAP	OPEN	54	FRP	Input inverting pulse of RGB output
23	VCC1	Supply voltage (+5V)	55	GND2	GND
24	VCC2	Supply voltage (+5V)	56	GND1	GND
25	YINH	Connect with 0.01 μ F to GND	57	HSYIN	Connects to external synchronous Signal without fail.
26	YOUT	OPEN	58	CSYNCOUT	OPEN
27	YCLAMP	OPEN	59	SYNCIN1	Synchronous signal input: 59 or 61pin.
28	PICTURE	OPEN	60	SYNCSW	Connects to H or L
29	SW	OPEN: composite mode only	61	SYNCIN2	Synchronous signal input: 59 or 61pin.
30	CONTRAST	Input fixed DC voltage	62	REGOUT	Connect to capacitor without fail.
31	GACLAMPR	Connect to clamp capacitor	63	VCOMAMP	OPEN
32	EXTINR	OPEN	64	VCOMIN	OPEN

■ None-use PIN Connection**1). Do not use VCOM Driver.**

63pin, 64pin and 1-4pin are OPEN.
5pin(VEE1) connect to GND.

2). Do not use composite mode demodulator.

Color demodulate system:

7pin, 9-11pin and 13-18pin are OPEN.
NTSC: 12pin connect to the DC voltage of 1.6V over.
PAL: 12pin connect to GND.

Brightness signal processing system:

21pin, 25pin connect with 0.01uF to GND.
22pin, 26-281pin are OPEN.

3). Do not use composite mode NTSC demodulator.

14pin, 15pin are OPEN.
12pin connect to GND.

4). Do not use composite mode PAL demodulator.

10pin, pin and 17-19pin are OPEN.
12pin connect to the DC voltage of 1V over.

5). Do not use external analog RGB input.

29pin, 32pin, 34pin and 36pin are OPEN.

6). Do not use synchronous signal processor.

Because it is necessary to produce BGP and Clamp Pulse in IC,
please use a synchronous signal processing circuit without fail.

7). Do not use the other SYNC IN terminal.

SYNC signal input 59pin or 61pin, either.
Please do not do both of 59pin, 61pin openly.
Please connect to 60pin with H at 59pin use, and connect to 60pin with L at 61pin use.

8). Do not use C-SYNC output.

58pin is OPEN.

9). Do not use the adjust terminal of interface and Gamma circuit.

As for 30pin, 37pin, 38pin, 44pin, please input DC voltage of request without fail.
39-42pin are OPEN.

10). Do not use SIDE BLACK circuit.

43pin is OPEN.

■ FUNCTION DESCRIPTION

1. Synchronous Mode

The composite signal or synchronous signal input to pin-59 (SYNCIN1) or pin-61 (SYNCIN2).

The signal that was input to pin-59 (SYNCIN1) or pin-61 (SYNCIN2) is separated synchronous and be switched by the input DC voltage of pin-60(SYNCSW).

The pin-57 (HSYIN) input external synchronous signal without fail.

In the case that HSY (Horizontal synchronous pulse) is not input, NJM2529 does not do a normal action, because inside clamp pulse does not generate.

2. Color Signal Play Mode

1) ACC Circuit (Automatic Chroma Control)

The chroma signal input to pin-6 (CIN), and detect the burst-signal through the HPF circuit, and controlled stable burst-signal feedback from demodulate output. When the pin-6 is GND level, the mode is composite input, and pin-21 (VIDEOIN) composite-video signal input to ACC circuit.

2) APC Circuit, and VCXO (Automatic Phase Control)

The burst signal level of chroma is constant by ACC circuit. The PLL circuit consists of VCXO and locked burst signal. The pin-12 (TINT) input DC voltage adjust the VCXO phase, and adjust the demodulate axis. When the pin-12 is GND, the mode is PAL, and only accepts analog RGB input.

3) Color Killer

The chroma signal is output to demodulator when PLL locked, and the color killer is - 42dB.

4) IDENT Circuit

NJM2529 synchronizes to H-SYNC in PAL mode. And, the career is reversing 90-degree phases.

IDENT circuit arranges the flip-flop polarity (that is driven by HD) and the color burst phase of the chroma signal that are input from 6-Pin (CIN). In the case that IDENT circuit does not act normally, Color-Killer acts, and the chroma signal is not output to de-modulator.

5) CLEANING

Cleaning filter avoids receiving the influence of burst signal noise that is input to APC and ACC circuit by tuning circuit. Chroma phase can be adjusted by utilizing this cleaning filter.

6) Color Circuit

This circuit adjusts the color TINT. The pin-13 (COLOR) adjusts the chroma signal range from ACC circuit.

This signal demodulator without burst signal by burst gate pulse (BGP).

7) DEMOD

This DEMOD circuits demodulate color differential signal after the ACC circuit. The RGB signal consists of color differential and Y signal by matrix circuit, and input to Int./Ext. signal switches.

3. Y-signal Mode

1) TRAP

The composite video signal input to pin-21 (VIDEOIN) without the chroma by TRAP circuit. The TPAP frequency is 3.58MHz or 4.43MHz, and not through when Y/C input mode.

2) Picture Circuit

The Y/composite-signal input to pin-21 (VIDEOIN) without the synchronous signal.

The pin-28 (PICTURE) adjusts the frequency characteristic around 2MHz and emphasizes the outline.

The pin-28 level emphasizes outline depend on the DC voltage. The Y-signal output pin-26 (YOUT), and input to pin-25 (YINH) through the external second differential circuit.

4. INT./EXT. Signal Switch Mode

The analog RGB signal (0.7V_{P-P} typ.) input to pin-32, pin-34, and pin-36, and these signal clamps pedestal.

The ext-signal select Y/C-signal or Int-signal by pin-29 (SW).

5. RGB Signal Mode

1) Contrast

The pin-30 (CONTRAST) adjusts the all of RGB signal, which is black-to-white range.

2) Gamma Amplifier

This circuit is non-linear amplifier to adjust the RGB signal equal to the luminous gamma characteristics.

There is two-point adjustment for accurate correction. The pin-37 (VG1) adjusts low side, and the pin-38 (VG2) adjusts high side.

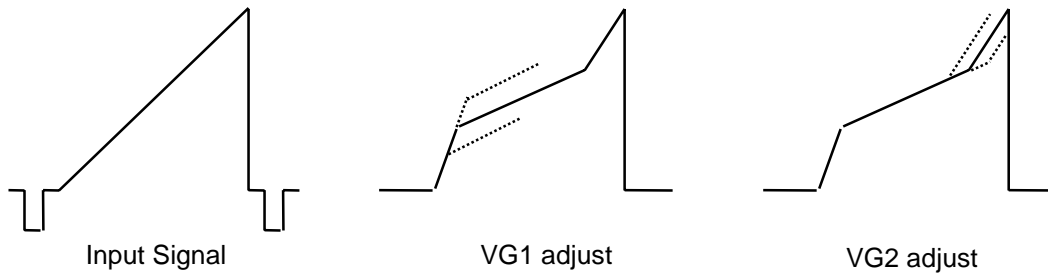

3) Sub Gamma Circuit

This circuit adjusts gamma characteristics of B/R signal, and sub gamma adjusts white-balance for the monitor. The pin-39 (SUBVG1R) and pin-41 (SUBVG2R) adjust low side with R-signal and high side with gamma characteristics. The pin-40 (SUBVG1B) and pin-42 (SUBVG2B) adjust low side with B-signal and high side for gamma characteristics. These terminal controls R-signal and B-signal separately.

4) Bright

The pin-44 (BRIGHT) clamps the pedestal after the brightness adjustment (black to black).

5) Side Black

The side-black circuit output black level, when the mode is black mask for wide picture.

The RGB signal is black level when pin-43 (SIDEBLACK) input signal is low period only.

6) Output Amplifier

The pin-54 (FRP) input to the timing pulse with inverting RGB output, and output the inverting RGB signal per every 1H. The RGB outputs are:

FRP-High: Non-inverting output

FRP-Low: Inverting output

The center voltage is preset to half of V_{cc} .

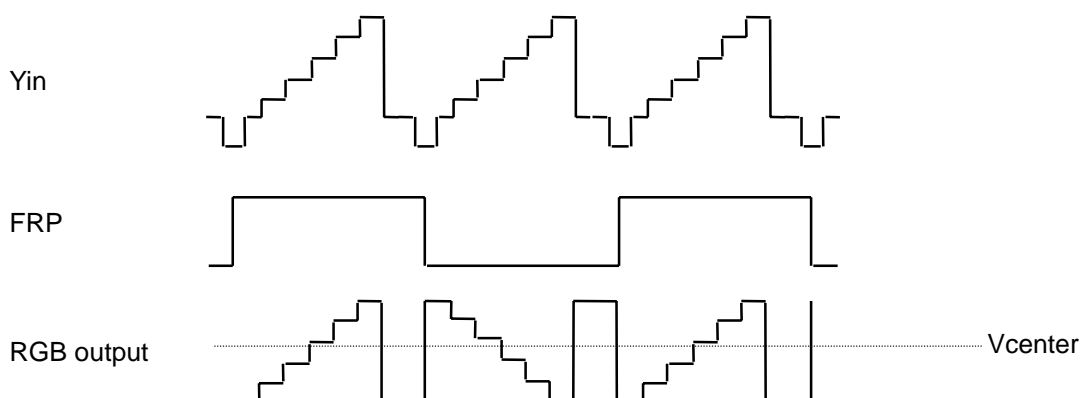

6. Common Driver

The LCD common invert RGB output, and the pin-64 (VCOMIN) input to the common driver signal ($5V_{P-P}$).

The pin-63 (VCOMAMP) adjusts the range, the pin-2 (VCOMCENT) adjusts the center voltage.

The pin-4 (VCOMOUT) connect external discreet buffer, and feedback the buffer output for pin-3 (VCOMFB).

[CAUTION]

The specifications on this databook are only given for information, without any guarantee as regards either mistakes or omissions. The application circuits in this databook are described only to show representative usages of the product and not intended for the guarantee or permission of any right including the industrial rights.