

QUARTZ CRYSTAL OSCILLATOR

■ GENERAL DESCRIPTION

The NJU6339 series is a C-MOS quartz crystal oscillator which consists of an oscillation amplifier, 3-stage divider and 3-state output buffer.

This series are classed into three groups A to D, H to L and Q to T according to their oscillation frequency range mentioned in the line-up table.

The oscillation amplifier incorporates feed-back resistance and oscillation capacitors(Cg, Cd), therefore, it requires no external component except quartz crystal.

The 3-stage divider generates f_0 , $f_0/2$, $f_0/4$ and $f_0/8$ and only one frequency selected by internal circuits is output.

The 3-state output buffer is C-MOS compatible and capable of 10 LSTTL driving.

The difference between NJU6339 and NJU6332 series is pin configuration only.

■ FEATURES

- Operating Voltage. -- 4.0~6.0V
- Maximum Oscillation Frequency (See Line-Up Table)
- Low Operating Current
- High Fan-out -- LSTTL 10
- 3-state Output Buffer
- Selected Frequency Output (mask option)
Only one frequency out of f_0 , $f_0/2$, $f_0/4$ and $f_0/8$ output
- Oscillation Capacitors Cg and Cd on-chip
- Oscillation and/or Output Stand-by Function
- Package Outline -- CHIP / EMP 8
- C-MOS Technology

■ LINE-UP TABLE

Type No.	Recommended Osc. Freq.	Output Freq.	Cg, Cd
NJU6339A 6339B 6339C 6339D	From 20 to 35MHz	f_0 $f_0/2$ $f_0/4$ $f_0/8$	28pF
NJU6339H 6339J 6339K 6339L	From 30 to 50MHz	f_0 $f_0/2$ $f_0/4$ $f_0/8$	20pF
NJU6339Q 6339R 6339S 6339T	From 45 to 75MHz	f_0 $f_0/2$ $f_0/4$ $f_0/8$	17pF

■ PACKAGE OUTLINE



NJU6339XC



NJU6339XE

■ PIN CONFIGURATION/PAD LOCATION

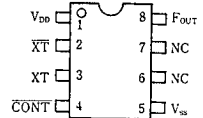
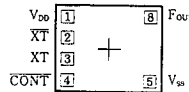

■ COORDINATES

Unit: μm

No.	PAD	X	Y
1	V _{DD}	-408	248
2	XT	-408	81
3	XT	-408	-86
4	CONT	-408	-248
5	V _{SS}	464	-248
8	F _{OUT}	464	248

Chip Size : 1.29 X 0.8mm
 Chip Center : X=0 μm , Y=0 μm
 Chip Thickness : 400 μm ±30 μm
 (Note) No. 6 and 7 terminals are only for package type information. There are no PAD on the chip.

■ BLOCK DIAGRAM

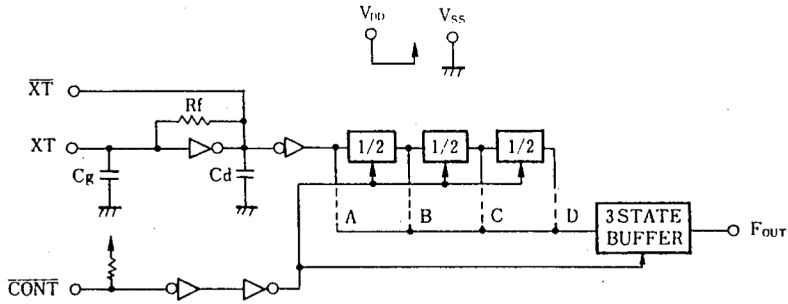

■ TERMINAL DESCRIPTION

NO.	SYMBOL	F U N C T I O N						
1	V_{DD}	+ 5V						
2	\overline{XT}	Quartz Crystal Connecting Terminals						
3	XT							
4	\overline{CONT}	3-State Output Control and Divider Reset						
		<table border="1"> <thead> <tr> <th>CONT</th> <th>F_{OUT}</th> </tr> </thead> <tbody> <tr> <td>H</td> <td>Output either one frequency from f_o, $f_o/2$, $f_o/4$ and $f_o/8$</td> </tr> <tr> <td>L</td> <td>Output High Impedance and Divider Reset</td> </tr> </tbody> </table>	CONT	F_{OUT}	H	Output either one frequency from f_o , $f_o/2$, $f_o/4$ and $f_o/8$	L	Output High Impedance and Divider Reset
		CONT	F_{OUT}					
H	Output either one frequency from f_o , $f_o/2$, $f_o/4$ and $f_o/8$							
L	Output High Impedance and Divider Reset							
5	V_{SS}	GND						
8	F_{OUT}	Output either one frequency from f_o , $f_o/2$, $f_o/4$ and $f_o/8$						

(Note) Reference the Line-Up Table

■ ABSOLUTE MAXIMUM RATINGS

 ($T_a=25^\circ\text{C}$)

PARAMETER	SYMBOL	RATINGS	UNIT
Supply Voltage	V_{DD}	-0.5 ~ +7.0	V
Input Voltage	V_{IN}	$V_{SS}-0.5 \sim V_{DD}+0.5$	V
Output Voltage	V_o	-0.5 ~ $V_{DD}+0.5$	V
Input Current	I_{IN}	± 10	mA
Output Current	I_o	± 25	mA
Power Dissipation	P_D	200 (EMP)	mW
Operating Temperature Range	T_{OPR}	-40 ~ + 85	$^\circ\text{C}$
Storage Temperature Range	T_{STG}	-55 ~ +125	$^\circ\text{C}$

 (Note) Decoupling capacitor should be connected between V_{DD} and V_{SS} due to the stabilized operation for the circuit.

■ ELECTRICAL CHARACTERISTICS

 ($T_a=25^{\circ}\text{C}$, $V_{DD}=5\text{V}$)

PARAMETER	SYMBOL	CONDITIONS	MIN	TYP	MAX	UNIT
Operating Voltage	V_{DD}		4		6	V
Operating Current	I_{DD1}	A,B,C,D, $f_{osc}=24\text{MHz}$, No Load			15	mA
	I_{DD2}	H,J,K,L, $f_{osc}=48\text{MHz}$, No Load			20	
	I_{DD3}	Q,R,S,T, $f_{osc}=48\text{MHz}$, No Load			25	
Stand-by Current	I_{st}	$\overline{\text{CONT}}, X_T=V_{SS}$, No Load (Note)			1	μA
Input Voltage	V_{IH}		3.5		5.0	V
	V_{IL}		0		1.5	
Output Current	I_{OH}	$V_{DD}=5\text{V}$, $V_{OH}=4.5\text{V}$	4			mA
	I_{OL}	$V_{DD}=5\text{V}$, $V_{OL}=0.5\text{V}$	4			
Input Current	I_{IN}	$\overline{\text{CONT}}$ Terminal, $\overline{\text{CONT}}=V_{SS}$	125	250	500	μA
3-St Off-leakage Current	I_{oz}	$\overline{\text{CONT}}=V_{SS}$, $F_{OUT}=V_{SS}$ and V_{DD}			± 0.1	μA
Internal Capacitor	C_g, C_d	A,B,C,D Version, $f_{osc}=24\text{MHz}$		28		pF
		H,J,K,L Version, $f_{osc}=48\text{MHz}$		20		
		Q,R,S,T Version, $f_{osc}=48\text{MHz}$		17		
Maximum Oscillation Frequency	f_{MAX}	A,B,C,D Version	35			MHz
		H,J,K,L Version	50			
		Q,R,S,T Version	75			
Output Signal Symmetry	SYM	$C_L=15\text{pF}$, $R_L=390\Omega$, at $1/2V_{DD}$	45	50	55	%
Output Signal Rise Time	t_r	$C_L=15\text{pF}$, 10~90%			6	ns
Output Signal Fall Time	t_f	$C_L=15\text{pF}$, 90~10%			4	ns

 Note) Excluding input current on $\overline{\text{CONT}}$ terminal.

4

■ MEASUREMENT CIRCUITS

(1) Output Signal Symmetry ($C_L=15\text{pF}$)

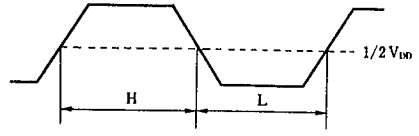
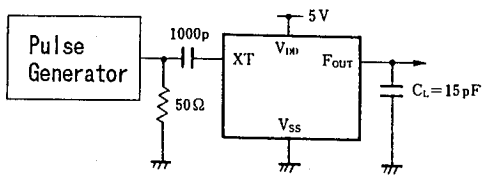

(2) Output Signal Rise / Fall Time ($C_L=15\text{pF}$)

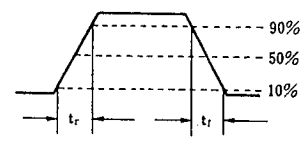
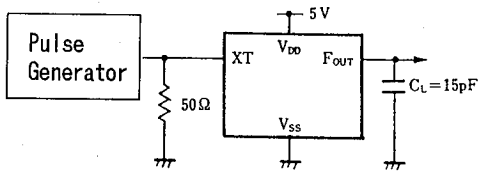

4

NJU6339 Series

MEMO

[CAUTION]

The specifications on this databook are only given for information, without any guarantee as regards either mistakes or omissions. The application circuits in this databook are described only to show representative usages of the product and not intended for the guarantee or permission of any right including the industrial rights.