

3·1/2 DIGIT SINGLE CHIP DIGITAL MULTIMETER LSI

■ GENERAL DESCRIPTION

The NJU9212 is 3·1/2 digit single chip digital multi-meter LSI with auto-ranging function. It consists of 3·1/2 digit dual-slope A/D converter, voltage reference, controller, oscillator, battery-life detector and LCD driver.

The NJU9212 provides the optimized functions for battery operated pencil or pocket type digitized multi-meter like as low operating voltage (3V), auto-ranging, LCD display direct driving, piezo buzzer direct driving and battery life indicator.

■ PACKAGE OUTLINE

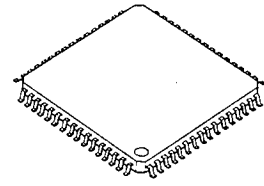

NJU9212F

■ FEATURES

- Low Operating Current
- Low Operating Voltage (3V)
- Dual-slope A/D Converter
- Auto-ranging
- LCD Display Direct Driving
- Voltage Doubler for LCD Driver On-chip
- Voltage Regulator for LCD Driving
- Piezo Buzzer Direct Driving
- Power-on Initialize
- Battery-life Detector
- Package Outline -- QFP64/Chip
- C-MOS Technology

■ PIN CONFIGURATION

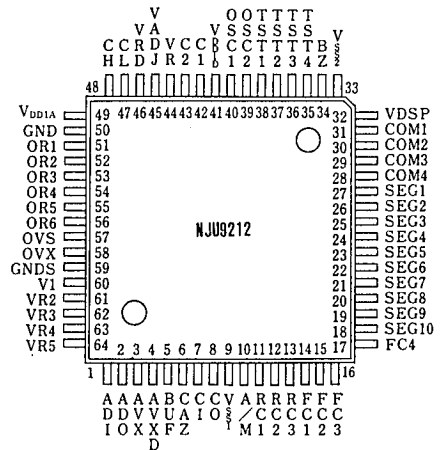

■ BLOCK DIAGRAM

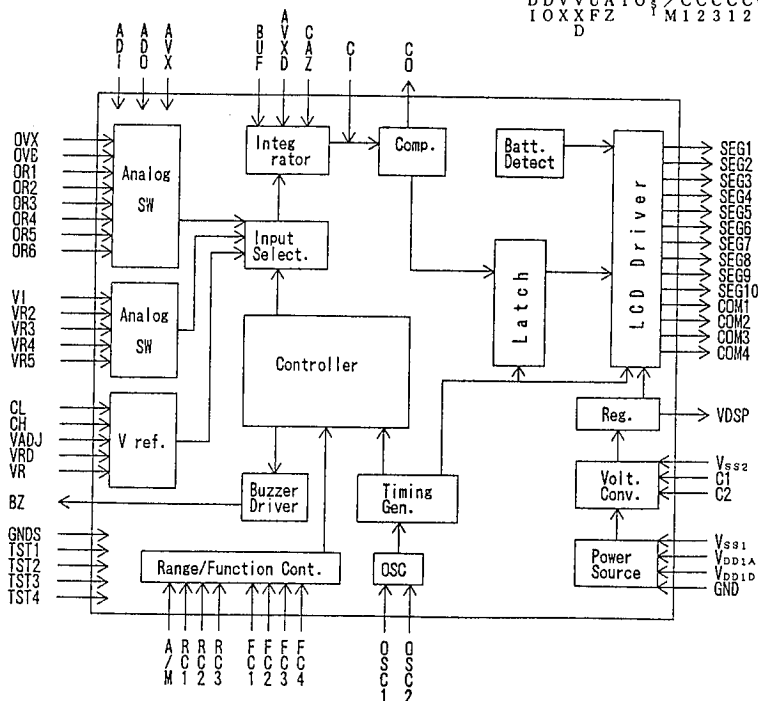

■ TERMINAL DESCRIPTION

NO.	SYMBOL	F U N C T I O N
1 2	AD1 ADO	AC → DC Conversion Input Terminal AC → DC Conversion Output Terminal
3 4	AVX AVXD	ADC "+" Input Terminal in AC Voltage Input ADC "-" Input Terminal in AC Voltage Input
5	BUF	Buffer Amplifier Output
6 7 8	CAZ CI CO	Auto-Zero Capacitor Connecting Terminal Integral Capacitor Connecting Terminal Comparator Output Terminal
10	A/M	Auto/Manual Selecting Input Terminal H Level: Auto L Level: Manual
11-13	RC1-RC3	Range Selecting Terminals (Note 1)
14-17	FC1-FC4	Function Selecting Terminals (Note 1)
18-27 28-31 32	SEG1-10 COM1-4 VDSP	LCD Segment Driver Output Terminals LCD Common Driver Output Terminals LCD Driving Voltage Monitor Terminal
34	BZ	Piezo Buzzer Driving Output Terminal
39,40	OSC2, OSC1	Quartz Crystal Connecting Terminals
42,43	C1,C2	Voltage Doubler Capacitor Connecting Terminals
44 45 46	VR VADJ VRD	Reference Voltage Output Terminal Reference Voltage Adjustment Terminal Reference Voltage Monitor Terminal
47,48	CL,CH	Reference Capacitor Connecting Terminals
51-56 57 58	OR1-6 OVS OVX	Reference Resistor Connecting Terminals for Resistance Measurement Reference Voltage Input Terminal for Resistance Measurement Measuring Voltage Input Terminal for Resistance Measurement
60	VI	Voltage Measurement Input Terminal
61-64	VR2-VR5	Bleeder Resistor Connecting Terminals
35-38	TST1-TST4	Test Terminals 1~4 (Normally Open)
9 33 41 49 50 59	V _{SS1} V _{SS2} V _{DD1D} V _{DD1A} GND GNDS	Analog, Digital GND Terminal 0V LCD Driving Voltage Supply Terminal -3V Digital Block Voltage Supply Terminal +3V Analog Block Voltage Supply Terminal +3V Analog Block Center point Voltage Supply Terminal +1.5V GND Sensing Terminal in Integral Operation

(Note 1) With Pull-Up resistance except the A/M terminal.

5

FUNCTIONAL DESCRIPTION
(1) MEASUREMENT FUNCTION

Measurement Function	Range	Auto or Manual
DC Voltage	200mV~400V 5-Range	Auto/Manual Range
AC Voltage	2V ~ 400V 4-Range	Auto/Manual Range
Resistance	100Ω~20MΩ 6-Range	Auto/Manual Range
Diode Check		
Continuity Check		

(2) MEASUREMENT FUNCTION SELECTION (By the FC1 ~ FC4 terminals input)

FUNCTION	FC1	FC2	FC3	FC4
DCV	H	H	H	H
ACV	L	H	H	H
Ω	H	H	L	H
▶	H	L	L	H
CONTI	H	H	H	L

(3) MEASUREMENT FUNCTION SELECTION SWITCH

The mechanical lock type or rotary type switch is required.

(4) THE KEY INPUT CONFIRMATION SOUND OF SWITCH OPERATION / SYSTEM RESET

Piezo buzzer driving signal for the key input confirmation sound and the system reset signal are output, when the switch is operated.

a) THE KEY INPUT CONFIRMATION SOUND SIGNAL(2kHz)

2kHz clock is output from BZ terminal about 31.25mS period at the rising or falling edge of input signals to the FC1 ~ FC4 terminals. This signal can drive a Piezo Buzzer directly.

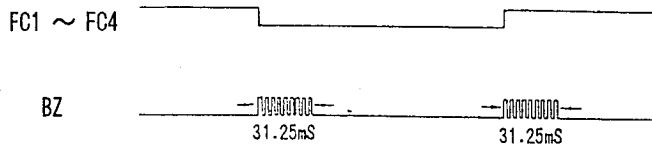

b) SYSTEM RESET SIGNAL

The range-set, counter-reset and auto-reset are performed synchronizing the rising or falling edge of input signals to the FC1 ~ FC4 terminals.

[Range-Set]

When the function was changed in the auto-range mode, the range is set as follows:

FUNCTION	RANGE	POINT
DCV	200mV	P1
ACV	2 V	P3
Ω	200 Ω	P1
	2 V	P3
CONT I	2k Ω	P3

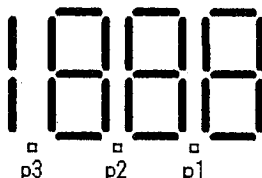
5
[COUNTER RESET]

When the function is changed even if the A/D conversion period, the counter reset signal is output internally and the LSI is initialized. Afterward, the A/D conversion is start from auto-zero cycle.

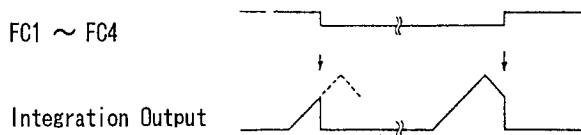
(5) CONTINUITY CHECK FUNCTION

When select continuity check function, 200 Ω range of Ω function is set automatically. If the measured value is less than 190 Ω , the buzzer sound is output continuously and the measured resistor value is displayed.

(6) DIODE CHECK FUNCTION

When select diode check function, 2k Ω range of k Ω function is set automatically and measured a diode forward voltage by supplied 1.5V. If the input terminals are open, the voltage corresponding to the battery voltage is displayed.

(7) FULL AUTO-RANGE FUNCTION (A/M=H Level)

① The following flow is performed by range control terminal (RC1):

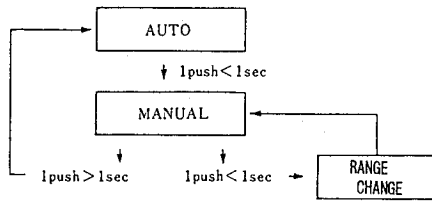

Apply the Momentary-type switch for the range control.

5

FUNCTION	A U T O		M A N U A L		RANGE CONTROL
		1 PUSH	1 PUSH (<1sec.)		
D C V	RNG1 ~ RNG5	→ HOLD	RNG _i → RNG _{i+1} (RNG5 → RNG1)		200mV ~ 400V
A C V	RNG1 ~ RNG4	→ HOLD	RNG _i → RNG _{i+1} (RNG4 → RNG1)		2V ~ 400V
Ω	RNG1 ~ RNG6	→ HOLD	RNG _i → RNG _{i+1} (RNG6 → RNG1)		200Ω ~ 20MΩ

② AUTO-RETURN FUNCTION

When the range selecting terminal is kept L level over than 1 sec or a function is changed by FC1~FC4 terminals, the range can be changed a function to auto range from any fixed range.

③ THE RANGE SELECTING CONFIRMATION SIGNAL

2kHz clock is output on BZ terminal about 31.25mS period at the falling edge of the RC1 terminal input. This signal can drive a Piezo Buzzer directly.

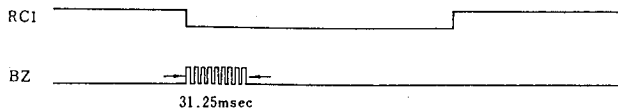

(8) MANUAL RANGE FUNCTION (A/M=L Level)

① Manual range is selected by RC1~RC3 as follows:

RC1	RC2	RC3	DCV	ACV	DCI, ACI	Ω
H	H	H	RNG2, 2V	RNG1, 2V	RNG1, 2mA	RNG2, 2K Ω
L	H	H	RNG3, 20V	RNG2, 20V	RNG2, 20mA	RNG3, 20K Ω
H	L	H	RNG4, 200V	RNG3, 200V	RNG3, 200mA	RNG4, 200K Ω
L	L	H	RNG5, 400V	RNG4, 400V	RNG4, 2000mA	RNG5, 2000K Ω
H	H	L	RNG5, 400V	RNG4, 400V	RNG5, 20A	RNG6, 20M Ω
L	H	L	RNG1, 200mV	RNG1, 2V	RNG1, 2mA	RNG1, 200 Ω

② MODE CHANGE OPERATION CONFIRMATION SOUND SIGNAL(2kHz)

2kHz clock is output on BZ terminal about 31.25mS period at the rising or falling edge of RC1 ~ FC3 terminals input. This signal can drive a Piezo Buzzer directly.

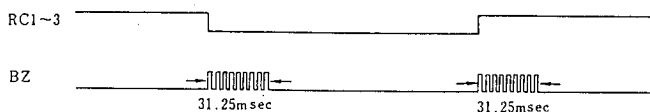

(9) CHATTER-FREE FUNCTION

All input terminals for control are build with the chatter-free circuits which eliminate chattering input less than 62.5mS

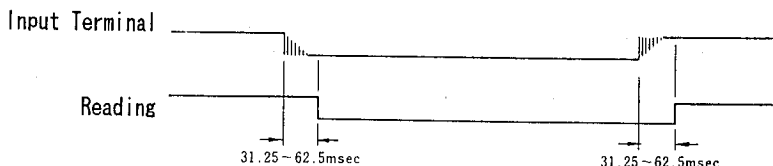

(10) BUZZER DRIVING SIGNAL

Adding to the switch operation confirmation signal output by FC1 ~ FC4 and RC1 ~ RC3, the buzzer driving signals is also output at the following conditions.

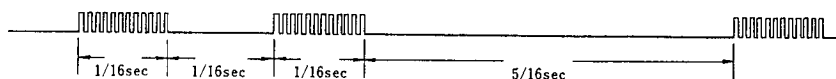
 ① Alarm sound for over range (except Ω)

② Confirmation for continuity



(11) LCD DISPLAY FUNCTION

- LCD Display pattern

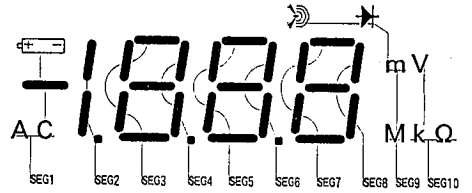
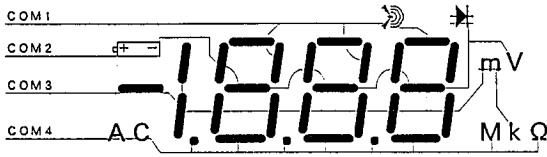



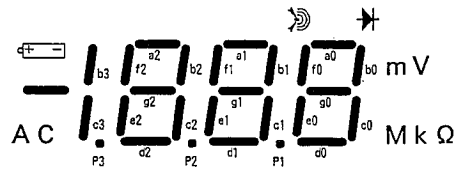



5



- Segment Assignment

	SEG1	SEG2	SEG3	SEG4	SEG5	SEG6	SEG7	SEG8	SEG9	SEG10
COM 1			a2	b2	a1	b1	a0	b0	>·)))	
COM 2	BATT		f2	g2	f1	g1	f0	g0	→+	V
COM 3	-	b3/c3	e2	c2	e1	c1	e0	c0	m	K
COM 4	AC	p3	d2	p2	d1	p1	d0		M	Ω

• Display Mark Explanation

- ① [BATT MARK] ()
[] is displayed when either the V_{DD} or V_{SS} becomes lower than 1.1V~1.3V.
- ② [-]
[-] is displayed when the DCV input is "-".
- ③ [AC]
[AC] is displayed when the ACV mode is selected.
- ④ []
[] is displayed when the continuity check function is selected.
- ⑤ []
[] is displayed when the diode check function is selected.
- ⑥ [mV]
[mV] is displayed when 200mV range of DCV is selected.
- ⑦ [V]
[V] is displayed when 2V, 20V, 200V and 400V range of DCV and ACV is selected.
- ⑧ [Ω]
[Ω] is displayed when the 200Ω range and continuity function is selected.
- ⑨ [kΩ]
[kΩ] is displayed when 2kΩ, 20kΩ, 200kΩ and 2000kΩ range is selected.
- ⑩ [MΩ]
[MΩ] is displayed when the 20MΩ range is selected.

(12) Power-On Initialization

When turn on the power, the power-on-initialization circuits performs

- All LCD Display ON
- Piezo buzzer driving signal output (about 62.5mS)
- Initializing the internal circuits.

■ ABSOLUTE MAXIMUM RATINGS

(Ta=25°C)

PARAMETER		SYMBOL	RATINGS	UNIT
Supply Voltage		$V_{DD1}-V_{SS1}$	4.0	V
		GND $-V_{SS1}$	2.0	
Control Terminal Input Voltage		V_{ID}	$V_{DD1} \sim V_{SS1}$	V
Analog Terminal Input Voltage		V_{IA}	$V_{DD1} \sim V_{SS1}$	V
Soldering Temperature		T_{SOL}	260	°C
Soldering Time		t_{SOL}	10	sec
Operating Temperature Range		T_{opr}	0 ~ + 50	°C
Storage Temperature Range		T_{stg}	- 40 ~ +125	°C
Input Current	Power Supply Term.	I_{DD}, I_{GND}, I_{SS}	± 50	mA
	ORI Terminal	I_{ORI}	± 50	
	Oth. Terminals	I_I, I_O	± 10	

5

■ ELECTRICAL CHARACTERISTICS

 (Ta=25°C, $V_{DD1}=3.0V$, GND=1.5V, DC 200mV Range)

PARAMETER	SYMBOL	CONDITIONS		MIN	TYP	MAX	UNIT
Operating Voltage	V_{DD1}	* 1		1.8	3.0	3.6	V
	GND			0.9	1.5	1.8	
Operating Current	I_{DD}					1.0	mA
Sampling Time	T_s				100		ms
Sampling Rate	N_f				2		Times/ sec
Linearity	L_{in}	R1=10MΩ R1=series input resistor				±0.2	%F.S
Rollover Error	E_p					±0.1	
Zero Input Reading	Zero			0	0	0	
Step Up Voltage	V_{SS2}	V_{SS2} Terminal			- 2.8		V
Input Voltage	V_{IH}	FC1~FC4, RC1~RC4,		2.45			V
	V_{IL}	A/M Terminals				0.55	V
Input Pull-up Resistance	R_I	FC1~FC4, RC1~RC4 Terminals		100	300	500	kΩ
Buzzer Driving Current	I_{OH}	BZ Terminal	$V_{OH}=2.7V$	0.25	0.75		mA
	I_{OL}		$V_{OL}=0.3V$	0.25	0.75		mA
Open-circuit Voltage for OHM Measurements	V_{Ω}	200Ω~20MΩ			0.43		V
Output Voltage	V_H	COM1~COM4			-1.03		V
	V_L	SEG1~SEG10			-2.07		
	V_{DSP}	(LCD driving waveform)			-3.10		
Input Leakage Current	I_{IL}	VI Terminal	$V_{in}=0mV$			± 10	pA
			$V_{in}=\pm 200mV$			±100	pA

 * 1) V_{DD1A} and V_{DD1D} are same voltage, so V_{DD1} is a generic term.

■ LCD Driving Waveform
(1/4duty, DC200mV Range, $V_{in}=0mV$)

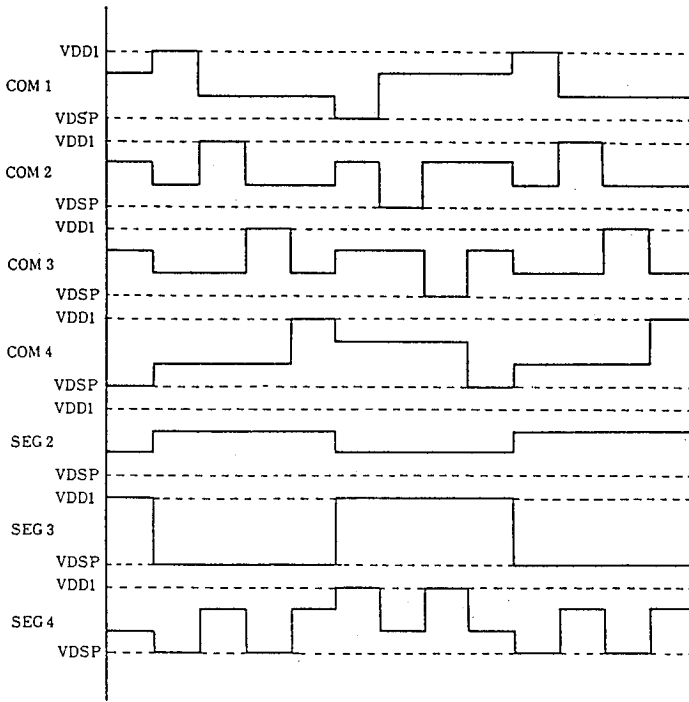

■ APPLICATION CIRCUIT (Auto-Range DMM)

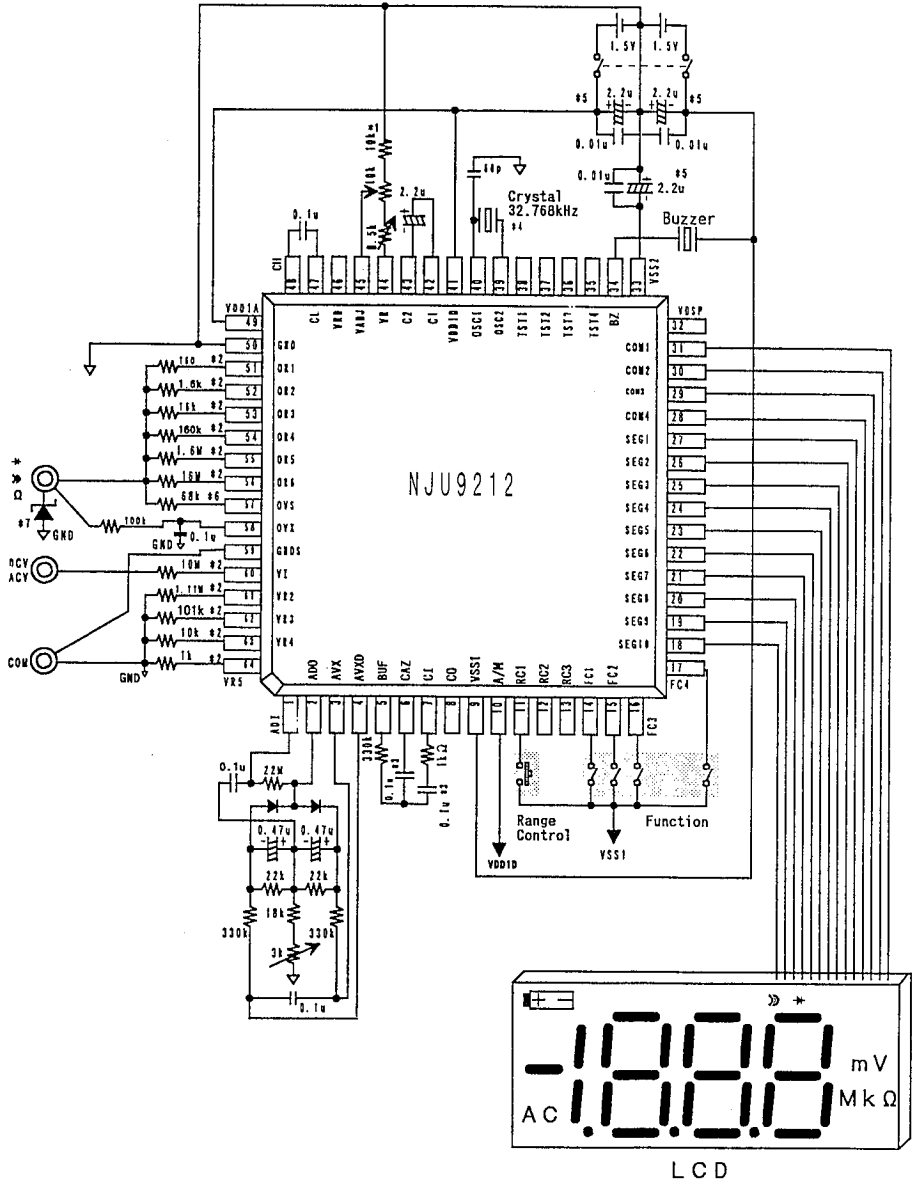

- *1 : Accuracy : less than $\pm 0.2\%$
The relative error of temperature characteristics : less than $\pm 50\text{ppm}$.
- *2 : Accuracy : less than $\pm 0.5\%$
No mentioned resistor : less than $\pm 1.0\%$
- *3 : Polypropylene film capacitor
- *4 : Quartz Crystal : 32.768kHz, $C1 \leq 30\text{k}\Omega$
- *5 : Decoupling Capacitor should be connected between V_{DD} and GND, V_{SS1} and GND, V_{SS2} and GND.
- *6 : Diode-check-function, if you demand to indicate at accuracy when input-terminal is released, replace resistance of $68\text{k}\Omega$ with variable-resistance and regulate it.
- *7 : Surely, connect Zenner-diode for input protection.
- *8 : If you demand to high level accuracy, regulate resistance for attenuator.

MEMO

[CAUTION]

The specifications on this databook are only given for information, without any guarantee as regards either mistakes or omissions. The application circuits in this databook are described only to show representative usages of the product and not intended for the guarantee or permission of any right including the industrial rights.

SUNSTAR 商斯达实业集团是集研发、生产、工程、销售、代理经销、技术咨询、信息服务等为一体的高科技企业，是专业高科技电子产品生产厂家，是具有 10 多年历史的专业电子元器件供应商，是中国最早和最大的仓储式连锁规模经营大型综合电子零部件代理分销商之一，是一家专业代理和分销世界各大品牌 IC 芯片和电子元器件的连锁经营综合性国际公司，专业经营进口、国产名厂名牌电子元件，型号、种类齐全。在香港、北京、深圳、上海、西安、成都等全国主要电子市场设有直属分公司和产品展示展销窗口门市部专卖店及代理分销商，已在全国范围内建成强大统一的供货和代理分销网络。我们专业代理经销、开发生产电子元器件、集成电路、传感器、微波光电元器件、工控机/DOC/DOM 电子盘、专用电路、单片机开发、MCU/DSP/ARM/FPGA 软件硬件、二极管、三极管、模块等，是您可靠的一站式现货配套供应商、方案提供商、部件功能模块开发配套商。商斯达实业公司拥有庞大的资料库，有数位毕业于著名高校——有中国电子工业摇篮之称的西安电子科技大学（西军电）并长期从事国防尖端科技研究的高级工程师为您精挑细选、量身订做各种高科技电子元器件，并解决各种技术问题。

微波光电部专业代理经销高频、微波、光纤、光电元器件、组件、部件、模块、整机；电磁兼容元器件、材料、设备；微波 CAD、EDA 软件、开发测试仿真工具；微波、光纤仪器仪表。欢迎国外高科技微波、光纤厂商将优秀产品介绍到中国、共同开拓市场。长期大量现货专业批发高频、微波、卫星、光纤、电视、CATV 器件：晶振、VCO、连接器、PIN 开关、变容二极管、开关二极管、低噪晶体管、功率电阻及电容、放大器、功率管、MMIC、混频器、耦合器、功分器、振荡器、合成器、衰减器、滤波器、隔离器、环行器、移相器、调制解调器；光电子元件和组件：红外发射管、红外接收管、光电开关、光敏管、发光二极管和发光二极管组件、半导体激光二极管和激光器组件、光电探测器和光接收组件、光发射接收模块、光纤激光器和光放大器、光调制器、光开关、DWDM 用光发射和接收器件、用户接入系统光收发器件与模块、光纤连接器、光纤跳线/尾纤、光衰减器、光纤适配器、光隔离器、光耦合器、光环行器、光复用器/转换器；无线收发芯片和模组、蓝牙芯片和模组。

更多产品请看本公司产品专用销售网站：

商斯达中国传感器科技信息网：<http://www.sensor-ic.com/>

商斯达工控安防网：<http://www.pc-ps.net/>

商斯达电子元器件网：<http://www.sunstare.com/>

商斯达微波光电产品网：[HTTP://www.rfoe.net/](http://www.rfoe.net/)

商斯达消费电子产品网：<http://www.icasic.com/>

商斯达实业科技产品网：<http://www.sunstars.cn/> 微波元器件销售热线：

地址：深圳市福田区福华路福庆街鸿图大厦 1602 室

电话：0755-82884100 83397033 83396822 83398585

传真：0755-83376182 (0) 13823648918 MSN: SUNS8888@hotmail.com

邮编：518033 E-mail:szss20@163.com QQ: 195847376

深圳赛格展销部：深圳华强北路赛格电子市场 2583 号 电话：0755-83665529 25059422

技术支持：0755-83394033 13501568376

欢迎索取免费详细资料、设计指南和光盘；产品凡多，未能尽录，欢迎来电查询。

北京分公司：北京海淀区知春路 132 号中发电子大厦 3097 号

TEL: 010-81159046 82615020 13501189838 FAX: 010-62543996

上海分公司：上海市北京东路 668 号上海赛格电子市场 D125 号

TEL: 021-28311762 56703037 13701955389 FAX: 021-56703037

西安分公司：西安高新开发区 20 所(中国电子科技集团导航技术研究所)

西安劳动南路 88 号电子商城二楼 D23 号

TEL: 029-81022619 13072977981 FAX:029-88789382