

eala

AUDIO PROCESSOR with Subwoofer Output

■ GENERAL DESCRIPTION

The **NJW1136** is a sound processor with subwoofer output includes all of functions processing audio signal for TV, such as tone control, balance, volume, mute, and AGC functions.

Also the **NJW1136** includes the LPF for subwoofer output and bass boost function.

The original surround system reproduces natural surround sound and clear vocal orientation.

All of internal status and variables are controlled by I²C BUS interface.

■ PACKAGE OUTLINE

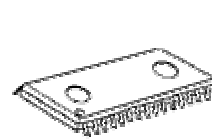
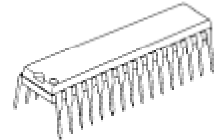
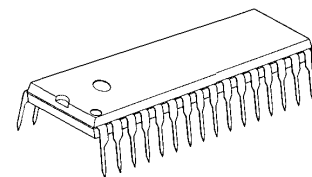
NJW1136GL1

NJW1136L

NJW1136D

■ FEATURES

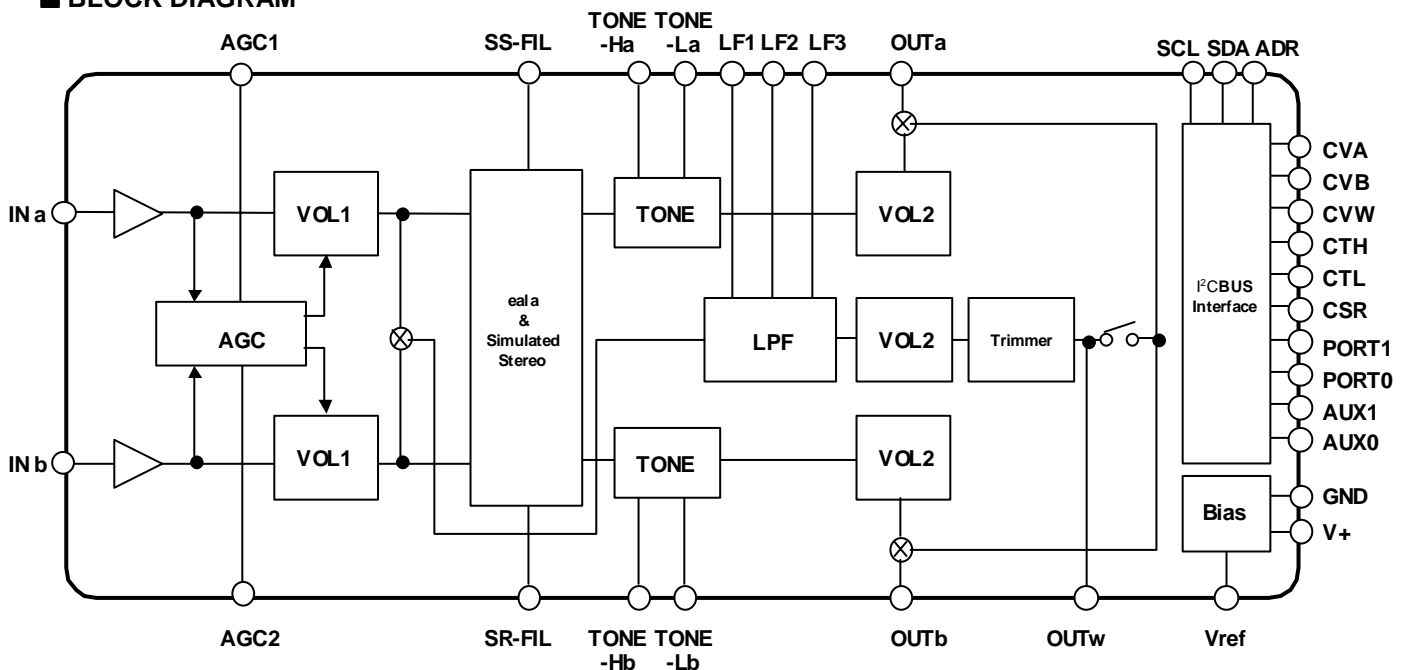
- Operating Voltage 8 to 13V
- 3ch Output(Lch, Rch, Subwoofer ch) / 2ch Output(Lch, Rch)
- LPF Filter (Adjustable cut off frequency by external parts)
- AGC Circuit (It reduces volume difference among input sources.)
Adjustable AGC boost level by external parts and AGC compression level by I²C BUS
- eala(NJRC Original Surround System)
- Simulated Stereo
- I²C BUS Interface
- Bi-CMOS Technology
- Package Outline SOP32, DIP32, SDIP32

■ BLOCK DIAGRAM



■PIN CONFIGURATION



No.	Symbol	Function	No.	Symbol	Function
1	INa	Ach input terminal	17	V+	Supply voltage terminal
2	SR-FIL	Surround filter terminal	18	Vref	Reference voltage terminal
3	SS-FIL	Simulated stereo filter terminal	19	CSR	DAC output terminal for surround control
4	TONE-Ha	Ach tone control (treble) filter terminal	20	CTL	DAC output terminal for tone control (bass)
5	TONE-La	Ach tone control (bass) filter terminal	21	CTH	DAC output terminal for tone control (treble)
6	OUTw	Subwoofer output terminal	22	CVW	Bch DAC output terminal for LPF trimmer
7	OUTa	Ach output terminal	23	CVB	Bch DAC output terminal for volume and balance
8	AGC1	AGC attack and recovery time setting terminal	24	CVA	Ach DAC output terminal for volume and balance
9	AUX0 ^(*)	Auxiliary 3 values voltage output terminal (0.0V, 2.5V, 5V)	25	AGC2	AGC boost level setting terminal
10	AUX1	Auxiliary 2 values voltage output terminal (0.0V, V+)	26	OUTb	Bch output terminal
11	PORT0	Logic input terminal	27	TONE-Lb	Bch tone control (bass) filter terminal
12	PORT1	Logic input terminal	28	TONE-Hb	Bch tone control (treble) filter terminal
13	ADR	Slave address setting terminal	29	LF3	LPF filter3 terminal
14	SDA	I ² C data terminal	30	LF2	LPF filter2 terminal
15	SCL	I ² C clock terminal	31	LF1	LPF filter1 terminal
16	GND	Ground terminal	32	INb	Bch input terminal

(*) The AUX0 terminal should be connected via the protection resistance to 5V device.

■ ABSOLUTE MAXIMUM RATING (Ta=25°C)

PARAMETER	SYMBOL	RATING	UNIT
Supply Voltage	V ⁺	15	V
Power Dissipation	P _D	700	mW
Operating Temperature Range	Topr	-20 to +75	°C
Storage Temperature Range	Tstg	-40 to +125	°C

■ ELECTRICAL CHARACTERISTICS

(Ta=25°C, V+=9V, Rg=600Ω, RL=47kΩ, Vin=100mVrms/1kHz unless otherwise specified)

PARAMETER	SYMBOL	Condition	Input			Output	MIN.	TYP.	MAX.	UNIT
			INa	INb						
Operating Voltage	V ⁺		-	-	-	8.0	9.0	13.0	V	
Supply Current	I _{CC}	No Signal	-	-	-	-	13	25	mA	
Reference Voltage	V _{REF}	No Signal	-	-	-	4.0	4.5	5.0	V	
Maximum Input Voltage	V _{IM}	VOL=-20dB, THD=1%	V _{in}	-	OUTa	2.8	3.0	-	Vrms	
			-	V _{in}	OUTb					
Maximum Output Voltage	V _{OM}	VOL=0dB, THD=1%	V _{in}	-	OUTa	-	2.5	-	Vrms	
			-	V _{in}	OUTb					
Channel Balance	G _{CB}	VOL=0dB	-	-	-	-1.5	0.0	1.5	dB	
Balance Boost A	BA _{BST}	CHS="0", BAL="111111"	V _{in}	V _{in}	OUTa	-2.0	0.0	2.0	dB	
Balance Cut A	BA _{CUT}	CHS="1", BAL="111111" Vin = 1Vrms	V _{in}	V _{in}	OUTa	-	-	-70	dB	
Balance Boost B	BB _{BST}	CHS="1", BAL="111111"	V _{in}	V _{in}	OUTb	-2.0	0.0	2.0	dB	
Balance Cut B	BB _{CUT}	CHS="0", BAL="111111" Vin = 1Vrms	V _{in}	V _{in}	OUTb	-	-	-70	dB	
Trimmer Boost	TR _{BST}	VOL=0dB TRIM = +18dB	V _{in}	V _{in}	OUTw	16.0	18.0	20.0	dB	
Trimmer Cut	TR _{CUT}	VOL=0dB TRIM = -44dB	V _{in}	V _{in}	OUTw	-49.0	-44.0	-39.0	dB	
Total Harmonic Distortion	THD	Vo=0.5Vrms, BW=400Hz to 30kHz	V _{in}	-	OUTa	-	-	0.5	%	
			-	V _{in}	OUTb					
Maximum Gain	G _{VMAX}	VOL=0dB	V _{in}	-	OUTa	-2.0	0.0	2.0	dB	
			-	V _{in}	OUTb					
Minimum Gain	G _{VMIN}	VOL=MUTE Vin=1Vrms	V _{in}	-	OUTa	-	-	-70	dB	
			-	V _{in}	OUTb					
Channel Separation	CS	Vin=1Vrms BW=400Hz to 30kHz	V _{in}	-	OUTb	-	-	-70	dB	
			-	V _{in}	OUTa					
Output Noise 1	V _{NO1}	VOL=0dB BW=400Hz to 30kHz	-	-	-	-	-90 (31.6)	-85 (56.2)	dBV (μVrms)	
Output Noise 2	V _{NO2}	VOL=MUTE BW=400Hz to 30kHz	-	-	-	-	-106 (5.0)	-96 (15.8)	dBV (μVrms)	

BW : Band Width

■ ELECTRICAL CHARACTERISTICS

(Ta=25°C, V+=9V, Rg=600Ω, RL=47kΩ, Vin=100mVrms/1kHz unless otherwise specified)

PARAMETER	SYMBOL	Condition	Input			Output	MIN.	TYP.	MAX.	UNIT
			Input		Output					
			INa	INb						
◆TONE										
High Frequency Boost	HF _{BST}	BCT="1" TREB=+15dB, f=10kHz	V _{in}	-	OUTa	12.5	15.0	17.5	dB	
			-	V _{in}	OUTb					
High Frequency Flat	HF _{FLT}	TREB=0, f=10kHz	V _{in}	-	OUTa	-2.0	0.0	2.0	dB	
			-	V _{in}	OUTb					
High Frequency Cut	HF _{CUT}	BCT="0" TREB=-15dB, f=10kHz	V _{in}	-	OUTa	-17.5	-15.0	-12.5	dB	
			-	V _{in}	OUTb					
Low Frequency Boost	LF _{BST}	BCB="1" BASS=+15dB, f=100Hz	V _{in}	-	OUTa	12.5	15.0	17.5	dB	
			-	V _{in}	OUTb					
Low Frequency Flat	LF _{FLT}	BASS=0, f=100Hz	V _{in}	-	OUTa	-2.0	0.0	2.0	dB	
			-	V _{in}	OUTb					
Low Frequency Cut	LF _{CUT}	BCB="0" BASS=-15dB, f=100Hz	V _{in}	-	OUTa	-17.5	-15.0	-12.5	dB	
			-	V _{in}	OUTb					
◆AGC										
AGC Boost	AGC _{BST}	Vin=50mVrms, f=1kHz AGC="1"	V _{in}	-	OUTa	1.5	3.5	5.5	dB	
			V _{in}	V _{in}	OUTb					
AGC Flat1	AGC _{FLT1}	Vin=100mVrms, f=1kHz AGC="1", AGCL="00"	V _{in}	V _{in}	OUTa	-2.5	0.0	2.5	dB	
			V _{in}	V _{in}	OUTb					
AGC Flat2	AGC _{FLT2}	Vin=200mVrms, f=1kHz AGC="1", AGCL="01"	V _{in}	V _{in}	OUTa	-2.5	0.0	2.5	dB	
			V _{in}	V _{in}	OUTb					
AGC Flat3	AGC _{FLT3}	Vin=300mVrms, f=1kHz AGC="1", AGCL="10"	V _{in}	V _{in}	OUTa	-2.5	0.0	2.5	dB	
			V _{in}	V _{in}	OUTb					
AGC Flat4	AGC _{FLT4}	Vin=400mVrms, f=1kHz AGC="1", AGCL="11"	V _{in}	V _{in}	OUTa	-2.5	0.0	2.5	dB	
			V _{in}	V _{in}	OUTb					
AGC Cut	AGC _{CUT}	Vin=2Vrms, f=1kHz AGC="1"	V _{in}	V _{in}	OUTa	-14	-10	-6.0	dB	
			V _{in}	V _{in}	OUTb					
◆SURROUND										
Surround Gain1	SR _{GAIN1}	f=100Hz Surround Effect1	V _{in}	-	OUTa	6.3	8.3	10.3	dB	
			-	V _{in}	OUTb					
Surround Gain2	SR _{GAIN2}	f=100Hz Surround Effect1	V _{in}	-	OUTb	2.1	4.1	6.1	dB	
			-	V _{in}	OUTa					
Surround Gain3	SR _{GAIN3}	f=100 Hz Surround Effect2	V _{in}	-	OUTa	10.7	12.7	14.7	dB	
			-	V _{in}	OUTb					
Surround Gain4	SR _{GAIN 4}	f=100Hz Surround Effect2	V _{in}	-	OUTb	8.4	10.4	12.4	dB	
			-	V _{in}	OUTa					
Simulated Stereo1	SR _{SIM1}	f=1kHz, Simulated Stereo	V _{in}	V _{in}	OUTa	1.0	3.0	5.0	dB	
Simulated Stereo2	SR _{SIM2}	f=1kHz, Simulated Stereo	V _{in}	V _{in}	OUTb	1.0	3.0	5.0	dB	
◆PORT, AUX										
PORT0,1 Input Voltage	V _{PTIN}	Input : High	-	-	-	3.5	-	-	V	
		Input : Low	-	-	-	-	-	1.0		
AUX0 Output Voltage	V _{AUX0}	Logic Output : High	-	-	-	4.5	-	5.5	V	
		Logic Output : Mid	-	-	-	2.0	-	3.0		
		Logic Output : Low	-	-	-	0	-	0.5		
AUX1 Output Voltage	V _{AUX1}	Logic Output : High	-	-	-	3.5	-	V+	V	
		Logic Output : Low	-	-	-	0	-	0.5		
ADR Input Voltage	V _{ADR}	Input : High	-	-	-	3.5	-	-	V	
		Input : Low	-	-	-	-	-	1.0		

■ I²C BUS BLOCK CHARACTERISTICS (SDA,SCL)

PARAMETER	SYMBOL	MIN.	TYP.	MAX.	UNIT
High Level Input Voltage	V _{IH}	3.0	-	5.0	V
Low Level Input Voltage	V _{IL}	0	-	1.5	V
High Level Input Current	I _{IH}	-	-	10	μA
Low Level Input Current	I _{IL}	-	-	10	μA
Low Level Output Voltage (3mA at SDA pin)	V _{OL}	0	-	0.4	V
Maximum Output Current	I _{OL}	-3.0	-	-	mA
Maximum Clock Frequency	f _{SCL}	-	-	100	kHz
Data Change Minimum Waiting Time	t _{BUF}	4.7	-	-	μs
Data Transfer Start Minimum Waiting Time	t _{HD:STA}	4.0	-	-	μs
Low Level Clock Pulse Width	t _{LOW}	4.7	-	-	μs
High Level Clock Pulse Width	t _{HIGH}	4.0	-	-	μs
Minimum Start Preparation Waiting Time	t _{SU:STA}	4.7	-	-	μs
Minimum Data Hold Time	t _{HD:DAT}	5.0	-	-	μs
Minimum Data Preparation Time	t _{SU:DAT}	250	-	-	ns
Rise Time	t _R	-	-	1.0	μs
Fall Time	t _F	-	-	300	ns
Minimum Stop Preparation Waiting Time	t _{SU:STO}	4.0	-	-	μs

I²C BUS Load Condition: Pull up resistance 4kΩ (Connected to +5V)
Load capacitance 200pF (Connected to GND)

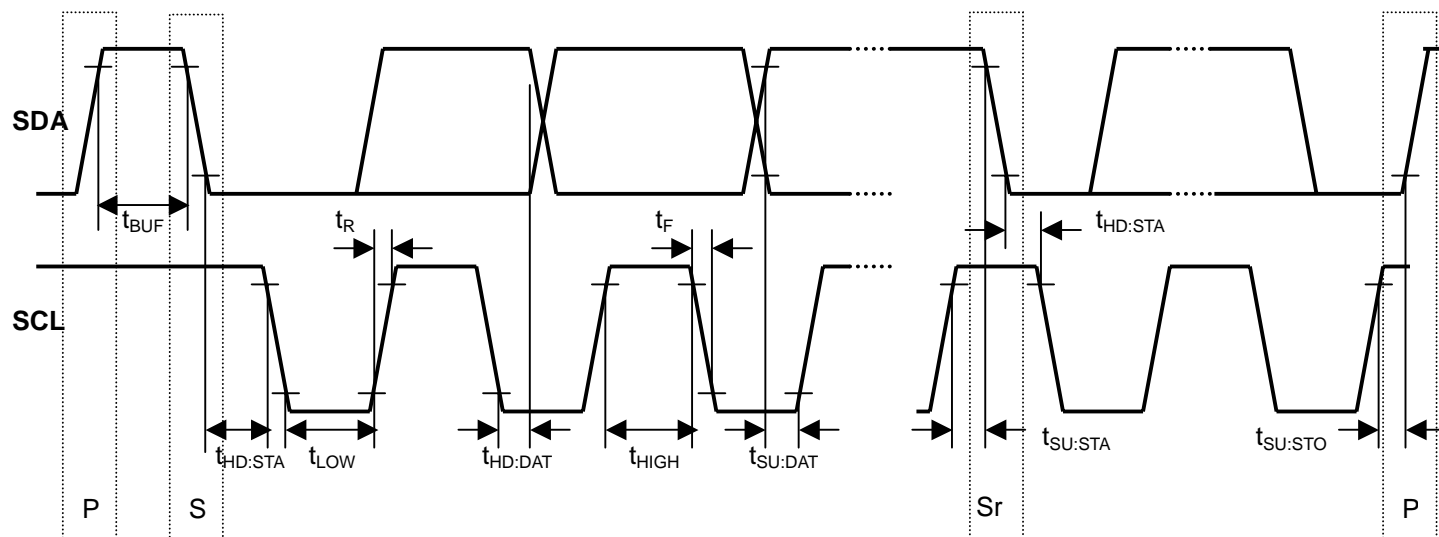

■TERMINAL DESCRIPTION

No.	SYMBOL	FUNCTION	EQUIVALENT CIRCUIT	VOLTAGE
1 32	INa INb	Ach input terminal Bch input terminal		V+/2
6 7 26	OUTw OUTa OUTb	Subwoofer output terminal Ach output terminal Bch output terminal		V+/2
2	SRFIL	Surround filter terminal		V+/2
3	SSFIL	Simulated stereo filter terminal		V+/2
4 28	TONE-Ha TONE-Hb	Treble(tone control) filter terminal		V+/2

■TERMINAL DESCRIPTION

No.	SYMBOL	FUNCTION	EQUIVALENT CIRCUIT	VOLTAGE
5 27	TONE-La TONE-Lb	Bass(tone control) filter terminal		V+/2
8	AGC1	Capacitor connection terminal for AGC attack and recovery time setting		1.4V
9	AUX0	Auxiliary 3 values voltage output terminal		0V, 2.5V, 5.0V
10	AUX1	Auxiliary 2 values voltage output terminal (Open collector type output)		0V 3.5 to V+
11 12 13	PORT0 PORT1 ADR	Logic input terminal Logic input terminal Slave address setting terminal (Don't apply over 5V to these terminals)		-

■TERMINAL DESCRIPTION

No.	SYMBOL	FUNCTION	EQUIVALENT CIRCUIT	VOLTAGE
14	SDA	I ² C data terminal		-
15	SCL	I ² C clock terminal		-
16 17	GND V+	Ground terminal Supply voltage terminal	-	V+/2
18	Vref	Reference voltage terminal		V+/2
19	CSR	DAC output for surround control terminal		0V

■TERMINAL DESCRIPTION

No.	SYMBOL	FUNCTION	EQUIVALENT CIRCUIT	VOLTAGE
20 21	CTL CTH	DAC output for tone control terminal		$V+/2$
22 23 24	CVW CVB CVA	DAC output terminal for trimmer control DAC output terminal for Bch volume control DAC output terminal for Ach volume control		$V+/2$
25	AGC2	Resistance connection terminal for AGC boost level setting		0V
29 30	LF3 LF2	LPF filter terminal		$V+/2+0.7V$
31	LF1	LPF filter terminal		$V+/2$

MEASUREMENT CIRCUIT

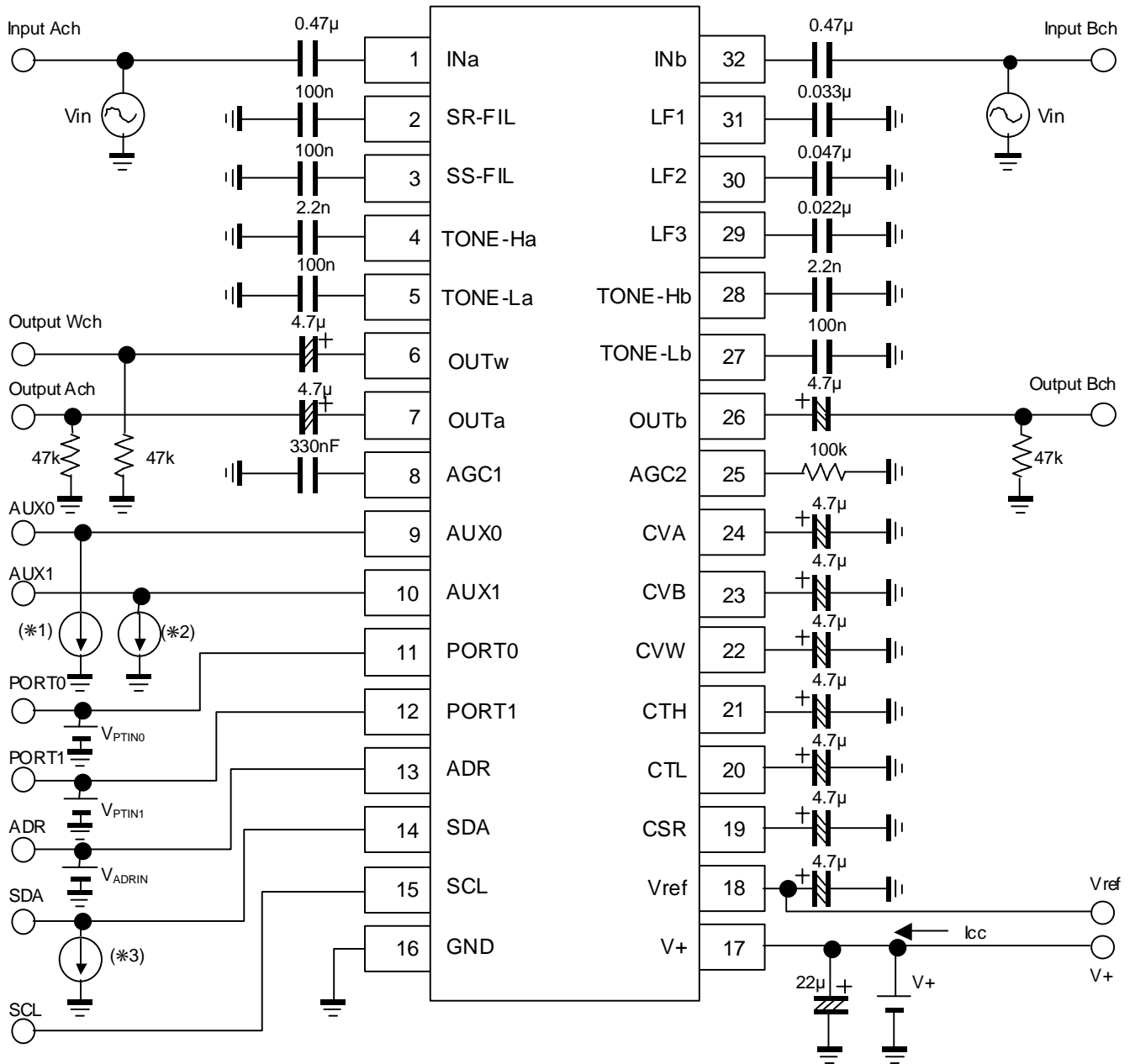

(*1)

V_{AUX0}	I_{AUX0}
Output High	+2mA
Output Low	-120µA

(*2)

V_{AUX1}	I_{AUX1}
Output Low	-3mA

(*3)

V_{OL}	I_{OL}
Output Low	-3mA

APPLICATION CIRCUIT

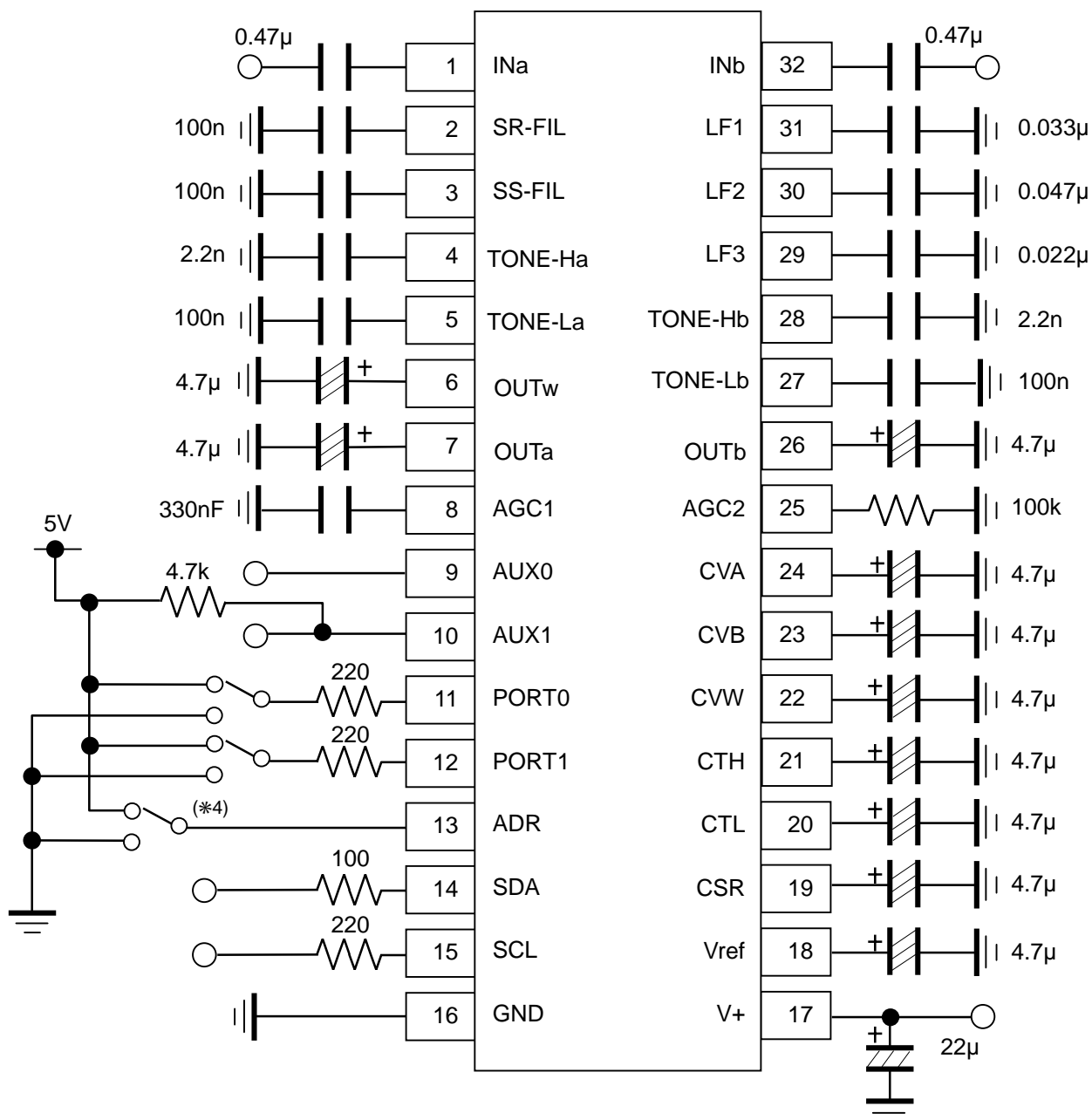

(*4) Set the Slave Address by "ADR" terminal.

ADR (Pin 13)	I ² C Slave Address	
	Read mode	Write mode
GND	80h	81h
+5V	82h	83h

(*5) Separate the I²C bus line and Signal line from the following terminals for avoiding digital noise problem and cross talk.

Pin No.	Symbol	Pin No.	Symbol	Pin No.	Symbol
2	SR-FIL	27	TONE-Lb	31	LF1
3	SS-FIL	28	TONE-Hb		
4	TONE-Ha	29	LF3		
5	TONE-La	30	LF2		

LPF Characteristics

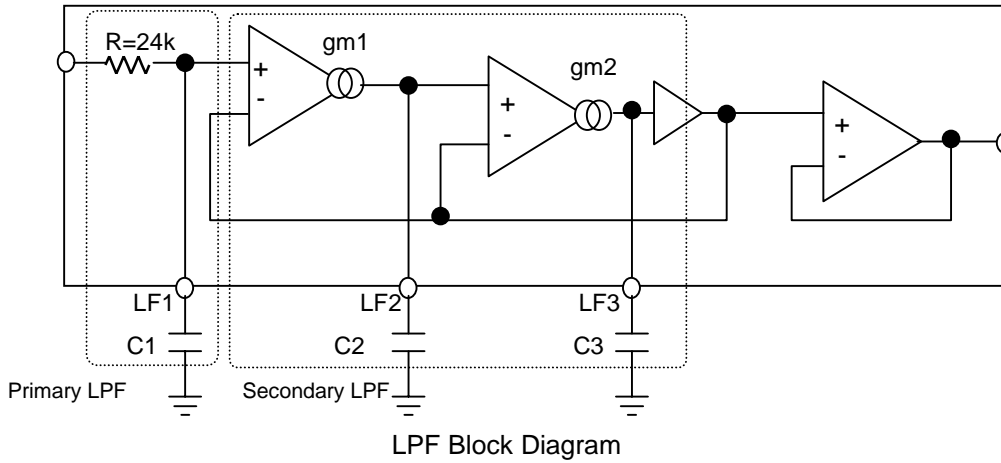

The **NJW1136** includes the LPF for subwoofer output and bass boost function. The LPF consists of primary and secondary LPF and it is enable to adjust “cut off frequency”, “Q” and “Roll off”. The expression of LPF characteristics is as follows.

<Primary LPF>

$$f_{c1} = \frac{1}{2\pi * R * C1} = \frac{1}{2\pi * 24 * 10^3 * C1} \quad Q_1 = 0.5$$

<Secondary LPF>

$$f_{c2} = \frac{42.9 * 10^{-6}}{2\pi * \sqrt{C2 * C3}} \quad Q_2 = 1.46 * \sqrt{\frac{C3}{C2}}$$

<LPF Frequency Response>

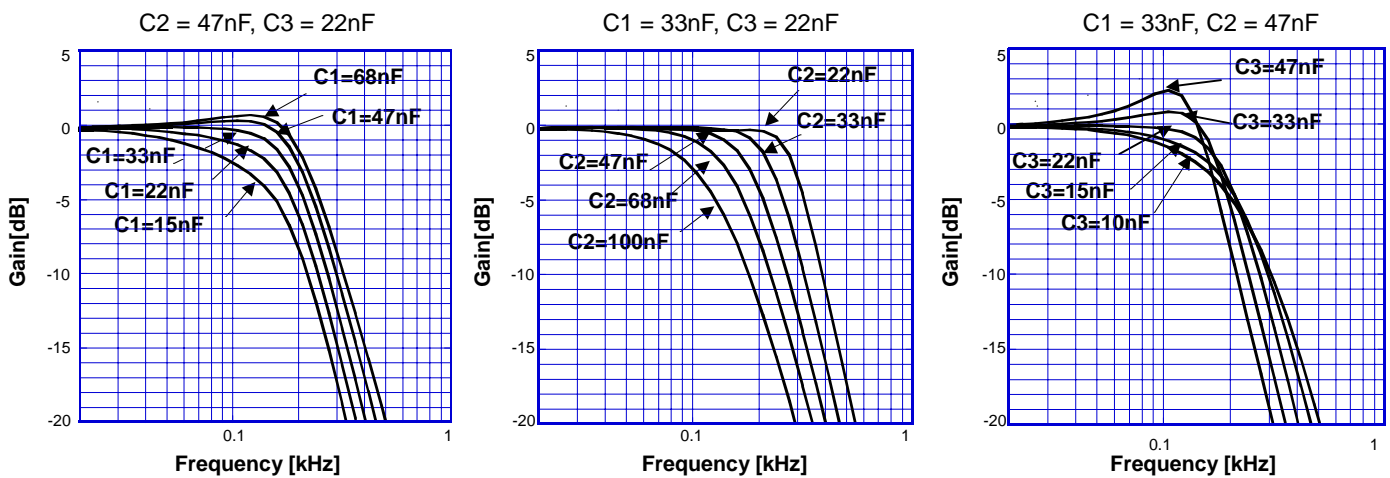

■ DEFINITION OF I²C REGISTER

◆ I²C BUS FORMAT



S: Starting Term
A: Acknowledge Bit
P: Ending Term

◆ SLAVE ADDRESS

R/W : Set the Write Mode or Read Mode.

ADR : Set the Slave Address by "ADR" terminal. (See Application Circuit)

Slave Address								Hex
MSB							LSB	
1	0	0	0	0	0	ADR	R/W	-
◆ R/W = 0 : Write Mode, ADR = 0/1								-
1	0	0	0	0	0	0	0	80(h)
1	0	0	0	0	0	1	0	82(h)
◆ R/W = 1 : Read Mode, ADR = 0/1								-
1	0	0	0	0	0	0	1	81(h)
1	0	0	0	0	0	1	1	83(h)

◆ CONTROL REGISTER TABLE

The select address sets each function (Volume, Balance, Bass Boost Select, AGC, Surround, Tone Control, AUX).

The auto increment function cycles the select address as follows.

00H → 01H → 02H → 03H → 04H → 05H → 00H

<Write Mode>

Select Address	BIT							
	D7	D6	D5	D4	D3	D2	D1	D0
00H	VOL							
01H	CHS	BAL						BBSW
02H	TRIM							*
03H	BCB	BASS					*	
04H	BCT	TREB					*	
05H	SUR		AUX1	AUX0		AGCL	AGC	

* : Don't Care

<Read Mode>

BIT							
D7	D6	D5	D4	D3	D2	D1	D0
1	1	1	1	1	1	PORT1	PORT0

•PORT1, PORT0 terminal setting

D1/D0	Remarks
0	D1/D0 output "0" at PORT1/PORT0 terminal receive High signal "1" (more than 3.5V)
1	D1/D0 output "1" at PORT1/PORT0 terminal receive Low signal "0" (less than 1.0V)

◆ CONTROL REGISTER DEFAULT VALUE

Control register default value is all "0".

Select Address	BIT							
	D7	D6	D5	D4	D3	D2	D1	D0
00H	0	0	0	0	0	0	0	0
01H	0	0	0	0	0	0	0	0
02H	0	0	0	0	0	0	0	0
03H	0	0	0	0	0	0	0	0
04H	0	0	0	0	0	0	0	0
05H	0	0	0	0	0	0	0	0

■ INSTRUCTION CODE

a) MASTER VOLUME SETTING

Select Address	BIT							
	D7	D6	D5	D4	D3	D2	D1	D0
00H	VOL							

•VOL Attenuation level : 0 to -80dB(0.33dB/step) , MUTE

The attenuator is consisted of both the VOL1(0.165dB/step)and VOL2(0.165dB/step) and is enable to adjust 0.33dB/step. The attenuation for both the VOL1and VOL2 are always synchronized to have the same attenuation levels for each other, and are not controllable independently for each other.

ex) VOL(-30dB) = VOL1(-15dB) + VOL2(-15dB)

b) BALANCE AND BASS BOOST FUNCTION SETTING

Select Address	BIT							
	D7	D6	D5	D4	D3	D2	D1	D0
01H	CHS	BAL						BBSW

•CHS : Channel select for balance control

“0” : Ach “Bch is attenuated”

“1” : Bch “Ach is attenuated”

•BAL : Balance control for both Ach and Bch

Balance Level : 0 to -60dB (1dB/Step) , MUTE

•BBSW : Bass Boost ON/OFF Switch

“0” = Bass Boost OFF

“1” = Bass Boost ON

c) TRIMMER LEVEL SETTING

Select Address	BIT							
	D7	D6	D5	D4	D3	D2	D1	D0
02H	TRIM							Don't Care

•TRIM : Trimmer Level

Trimmer Level : +18 to -44dB (0.5dB/Step) , MUTE

d) TONE CONTROL BASS SETTING

Select Address	BIT							
	D7	D6	D5	D4	D3	D2	D1	D0
03H	BCB	BASS					Don't Care	

•BCB : Boost cut select for Bass control

“0” : Cut

“1” : Boost

•BASS : BASS Level Setting

Cut Level : -15 to 0dB(0.5dB/Step)

Boost Level : 0 to +15dB(0.5dB/Step)

d) TONE CONTROL TREBLE SETTING

Select Address	BIT							
	D7	D6	D5	D4	D3	D2	D1	D0
04H	BCT	TREB					Don't Care	

•BCT : Boost cut select for Treble control

“0” : Cut

“1” : Boost

•TREB : TREBLE Level Setting

Cut Level : -15 to 0dB(0.5dB/Step)

Boost Level : 0 to +15dB(0.5dB/Step)

d) SURROUND, AUXILIARY, AGC LEVEL SETTING

Select Address	BIT							
	D7	D6	D5	D4	D3	D2	D1	D0
05H	SUR		AUX1	AUX0		AGCL		AGC

<SUR : Surround Level Setting>

Surround Setting	D7	D6	Remarks
Surround Off	0	0	Surround Off
Simulated Stereo	0	1	Simulated Stereo
Surround Effect1	1	0	Surround Effect Low(8.3dB typ.)
Surround Effect2	1	1	Surround Effect High(12.7dB typ.)

<AUX1 : AUX1 Terminal Setting>

Auxiliary Setting	D5
Low (0.0V)	0
High (5.0V)	1

<AUX0 : AUX0 Terminal Setting>

Auxiliary Setting	D4	D3
Low (0.0V)	-	0
Mid (2.5V)	0	1
High (5.0V)	1	1

<AGCL : AGC Level Setting>

AGC Level Setting	D2	D1
100mVrms	0	0
200mVrms	0	1
300mVrms	1	0
400mVrms	1	1

<AGC : AGC Setting>

AGC Setting	D0
OFF	0
ON	1

■Master Volume (Select Address : 00H)

		VOL							
Gain(dB)	HEX	D7	D6	D5	D4	D3	D2	D1	D0
0	FF	1	1	1	1	1	1	1	1
-1	FC	1	1	1	1	1	1	0	0
-2	F9	1	1	1	1	1	0	0	1
-3	F6	1	1	1	1	0	1	1	0
-4	F3	1	1	1	1	0	0	1	1
-5	F0	1	1	1	1	0	0	0	0
-6	ED	1	1	1	0	1	1	0	1
-7	EA	1	1	1	0	1	0	1	0
-8	E7	1	1	1	0	0	1	1	1
-9	E4	1	1	1	0	0	1	0	0
-10	E1	1	1	1	0	0	0	0	1
-11	DE	1	1	0	1	1	1	1	0
-12	DB	1	1	0	1	1	0	1	1
-13	D8	1	1	0	1	1	0	0	0
-14	D5	1	1	0	1	0	1	0	1
-15	D2	1	1	0	1	0	0	1	0
-16	CF	1	1	0	0	1	1	1	1
-17	CC	1	1	0	0	1	1	0	0
-18	C9	1	1	0	0	1	0	0	1
-19	C6	1	1	0	0	0	1	1	0
-20	C3	1	1	0	0	0	0	1	1
-21	C0	1	1	0	0	0	0	0	0
-22	BD	1	0	1	1	1	1	0	1
-23	BA	1	0	1	1	1	0	1	0
-24	B7	1	0	1	1	0	1	1	1
-25	B4	1	0	1	1	0	1	0	0
-26	B1	1	0	1	1	0	0	0	1
-27	AE	1	0	1	0	1	1	1	0
-28	AB	1	0	1	0	1	0	1	1
-29	A8	1	0	1	0	1	0	0	0
-30	A5	1	0	1	0	0	1	0	1
-31	A2	1	0	1	0	0	0	1	0
-32	9F	1	0	0	1	1	1	1	1
-33	9C	1	0	0	1	1	1	0	0
-34	99	1	0	0	1	1	0	0	1
-35	96	1	0	0	1	0	1	1	0
-36	93	1	0	0	1	0	0	1	1
-37	90	1	0	0	1	0	0	0	0
-38	8D	1	0	0	0	1	1	0	1
-39	8A	1	0	0	0	1	0	1	0
-40	87	1	0	0	0	0	1	1	1
-41	84	1	0	0	0	0	1	0	0
-42	81	1	0	0	0	0	0	0	1

		VOL							
		D7	D6	D5	D4	D3	D2	D1	D0
Gain(dB)	HEX								
-43	7E	0	1	1	1	1	1	1	0
-44	7B	0	1	1	1	1	0	1	1
-45	78	0	1	1	1	1	0	0	0
-46	75	0	1	1	1	0	1	0	1
-47	72	0	1	1	1	0	0	1	0
-48	6F	0	1	1	0	1	1	1	1
-49	6C	0	1	1	0	1	1	0	0
-50	69	0	1	1	0	1	0	0	1
-51	66	0	1	1	0	0	1	1	0
-52	63	0	1	1	0	0	0	1	1
-53	60	0	1	1	0	0	0	0	0
-54	5D	0	1	0	1	1	1	0	1
-55	5A	0	1	0	1	1	0	1	0
-56	57	0	1	0	1	0	1	1	1
-57	54	0	1	0	1	0	1	0	0
-58	51	0	1	0	1	0	0	0	1
-59	4E	0	1	0	0	1	1	1	0
-60	4B	0	1	0	0	1	0	1	1
-61	48	0	1	0	0	1	0	0	0
-62	45	0	1	0	0	0	1	0	1
-63	42	0	1	0	0	0	0	1	0
-64	3F	0	0	1	1	1	1	1	1
-65	3C	0	0	1	1	1	1	0	0
-66	39	0	0	1	1	1	0	0	1
-67	36	0	0	1	1	0	1	1	0
-68	33	0	0	1	1	0	0	1	1
-69	30	0	0	1	1	0	0	0	0
-70	2D	0	0	1	0	1	1	0	1
-71	2A	0	0	1	0	1	0	1	0
-72	27	0	0	1	0	0	1	1	1
-73	24	0	0	1	0	0	1	0	0
-74	21	0	0	1	0	0	0	0	1
-75	1E	0	0	0	1	1	1	1	0
-76	1B	0	0	0	1	1	0	1	1
-77	18	0	0	0	1	1	0	0	0
-78	15	0	0	0	1	0	1	0	1
-79	12	0	0	0	1	0	0	1	0
-80	0F	0	0	0	0	1	1	1	1
MUTE*	00	0	0	0	0	0	0	0	0

* : Default Value

■Balance, Bass Boost Setting (Select Address : 01H)

Channel Setting (CHS)	D7
Decrease Bch Gain	0
Decrease Ach Gain	1

Gain(dB)	BAL					
	D6	D5	D4	D3	D2	D1
0*	0	0	0	0	0	0
-1	0	0	0	0	0	1
-2	0	0	0	0	1	0
-3	0	0	0	0	1	1
-4	0	0	0	1	0	0
-5	0	0	0	1	0	1
-6	0	0	0	1	1	0
-7	0	0	0	1	1	1
-8	0	0	1	0	0	0
-9	0	0	1	0	0	1
-10	0	0	1	0	1	0
-11	0	0	1	0	1	1
-12	0	0	1	1	0	0
-13	0	0	1	1	0	1
-14	0	0	1	1	1	0
-15	0	0	1	1	1	1
-16	0	1	0	0	0	0
-17	0	1	0	0	0	1
-18	0	1	0	0	1	0
-19	0	1	0	0	1	1
-20	0	1	0	1	0	0
-21	0	1	0	1	0	1
-22	0	1	0	1	1	0
-23	0	1	0	1	1	1
-24	0	1	1	0	0	0
-25	0	1	1	0	0	1
-26	0	1	1	0	1	0
-27	0	1	1	0	1	1
-28	0	1	1	1	0	0
-29	0	1	1	1	0	1
-30	0	1	1	1	1	0

* : Default Value

Gain(dB)	BAL					
	D6	D5	D4	D3	D2	D1
-31	0	1	1	1	1	1
-32	1	0	0	0	0	0
-33	1	0	0	0	0	1
-34	1	0	0	0	1	0
-35	1	0	0	0	1	1
-36	1	0	0	1	0	0
-37	1	0	0	1	0	1
-38	1	0	0	1	1	0
-39	1	0	0	1	1	1
-40	1	0	1	0	0	0
-41	1	0	1	0	0	1
-42	1	0	1	0	1	0
-43	1	0	1	0	1	1
-44	1	0	1	1	0	0
-45	1	0	1	1	0	1
-46	1	0	1	1	1	0
-47	1	0	1	1	1	1
-48	1	1	0	0	0	0
-49	1	1	0	0	0	1
-50	1	1	0	0	1	0
-51	1	1	0	0	1	1
-52	1	1	0	1	0	0
-53	1	1	0	1	0	1
-54	1	1	0	1	1	0
-55	1	1	0	1	1	1
-56	1	1	1	0	0	0
-57	1	1	1	0	0	1
-58	1	1	1	0	1	0
-59	1	1	1	0	1	1
-60	1	1	1	1	0	0
MUTE	1	1	1	1	1	1

Bass Boost Setting (BBSW)	D0
Bass Boost Off*	0
Bass Boost On	1

* : Default Value

■Trimmer Setting (Select Address: 02H)

Gain(dB)	TRIM						
	D7	D6	D5	D4	D3	D2	D1
+18.0	1	1	1	1	1	1	1
+17.5	1	1	1	1	1	1	0
+17.0	1	1	1	1	1	0	1
+16.5	1	1	1	1	1	0	0
+16.0	1	1	1	1	0	1	1
+15.5	1	1	1	1	0	1	0
+15.0	1	1	1	1	0	0	1
+14.5	1	1	1	1	0	0	0
+14.0	1	1	1	0	1	1	1
+13.5	1	1	1	0	1	1	0
+13.0	1	1	1	0	1	0	1
+12.5	1	1	1	0	1	0	0
+12.0	1	1	1	0	0	1	1
+11.5	1	1	1	0	0	1	0
+11.0	1	1	1	0	0	0	1
+10.5	1	1	1	0	0	0	0
+10.0	1	1	0	1	1	1	1
+9.5	1	1	0	1	1	1	0
+9.0	1	1	0	1	1	0	1
+8.5	1	1	0	1	1	0	0
+8.0	1	1	0	1	0	1	1
+7.5	1	1	0	1	0	1	0
+7.0	1	1	0	1	0	0	1
+6.5	1	1	0	1	0	0	0
+6.0	1	1	0	0	1	1	1
+5.5	1	1	0	0	1	1	0
+5.0	1	1	0	0	1	0	1
+4.5	1	1	0	0	1	0	0
+4.0	1	1	0	0	0	1	1
+3.5	1	1	0	0	0	1	0
+3.0	1	1	0	0	0	0	1
+2.5	1	1	0	0	0	0	0
+2.0	1	0	1	1	1	1	1
+1.5	1	0	1	1	1	1	0
+1.0	1	0	1	1	1	0	1
+0.5	1	0	1	1	1	0	0
0.0	1	0	1	1	0	1	1
-0.5	1	0	1	1	0	1	0
-1.0	1	0	1	1	0	0	1
-1.5	1	0	1	1	0	0	0
-2.0	1	0	1	0	1	1	1
-2.5	1	0	1	0	1	1	0
-3.0	1	0	1	0	1	0	1
-3.5	1	0	1	0	1	0	0
-4.0	1	0	1	0	0	1	1
-4.5	1	0	1	0	0	1	0
-5.0	1	0	1	0	0	0	1
-5.5	1	0	1	0	0	0	0
-6.0	1	0	0	1	1	1	1

Gain(dB)	TRIM						
	D7	D6	D5	D4	D3	D2	D1
-6.5	1	0	0	1	1	1	0
-7.0	1	0	0	1	1	0	1
-7.5	1	0	0	1	1	0	0
-8.0	1	0	0	1	0	1	1
-8.5	1	0	0	1	0	1	0
-9.0	1	0	0	1	0	0	1
-9.5	1	0	0	1	0	0	0
-10.0	1	0	0	0	1	1	1
-10.5	1	0	0	0	1	1	0
-11.0	1	0	0	0	1	0	1
-11.5	1	0	0	0	1	0	0
-12.0	1	0	0	0	0	1	1
-12.5	1	0	0	0	0	1	0
-13.0	1	0	0	0	0	0	1
-13.5	1	0	0	0	0	0	0
-14.0	0	1	1	1	1	1	1
-14.5	0	1	1	1	1	1	0
-15.0	0	1	1	1	1	0	1
-15.5	0	1	1	1	1	0	0
-16.0	0	1	1	1	0	1	1
-16.5	0	1	1	1	0	1	0
-17.0	0	1	1	1	0	0	1
-17.5	0	1	1	1	0	0	0
-18.0	0	1	1	0	1	1	1
-18.5	0	1	1	0	1	1	0
-19.0	0	1	1	0	1	0	1
-19.5	0	1	1	0	1	0	0
-20.0	0	1	1	0	0	1	1
-20.5	0	1	1	0	0	1	0
-21.0	0	1	1	0	0	0	1
-21.5	0	1	1	0	0	0	0
-22.0	0	1	0	1	1	1	1
-22.5	0	1	0	1	1	1	0
-23.0	0	1	0	1	1	0	1
-23.5	0	1	0	1	1	0	0
-24.0	0	1	0	1	0	1	1
-24.5	0	1	0	1	0	1	0
-25.0	0	1	0	1	0	0	1
-25.5	0	1	0	1	0	0	0
-26.0	0	1	0	0	1	1	1
-26.5	0	1	0	0	1	1	0
-27.0	0	1	0	0	1	0	1
-27.5	0	1	0	0	1	0	0
-28.0	0	1	0	0	0	1	1
-28.5	0	1	0	0	0	1	0
-29.0	0	1	0	0	0	0	1
-29.5	0	1	0	0	0	0	0
-30.0	0	0	1	1	1	1	1
-30.5	0	0	1	1	1	1	0
-31.0	0	0	1	1	1	0	1

Gain (dB)	TRIM						
	D7	D6	D5	D4	D3	D2	D1
-31.5	0	0	1	1	1	0	0
-32.0	0	0	1	1	0	1	1
-32.5	0	0	1	1	0	1	0
-33.0	0	0	1	1	0	0	1
-33.5	0	0	1	1	0	0	0
-34.0	0	0	1	0	1	1	1
-34.5	0	0	1	0	1	1	0
-35.0	0	0	1	0	1	0	1
-35.5	0	0	1	0	1	0	0
-36.0	0	0	1	0	0	1	1
-36.5	0	0	1	0	0	1	0
-37.0	0	0	1	0	0	0	1
-37.5	0	0	1	0	0	0	0
-38.0	0	0	0	1	1	1	1
-38.5	0	0	0	1	1	1	0
-39.0	0	0	0	1	1	0	1
-39.5	0	0	0	1	1	0	0
-40.0	0	0	0	1	0	1	1
-40.5	0	0	0	1	0	1	0
-41.0	0	0	0	1	0	0	1
-41.5	0	0	0	1	0	0	0
-42.0	0	0	0	0	1	1	1
-42.5	0	0	0	0	1	1	0
-43.0	0	0	0	0	1	0	1
-43.5	0	0	0	0	1	0	0
-44.0	0	0	0	0	0	1	1
MUTE*	0	0	0	0	0	0	0

* : Default value

■Tone Control(Bass Setting) (Select Address : 03H)

Bass Cut or Boost	BCB
	D7
Cut	0
Boost	1

Cut Gain(dB) / Boost Gain(dB)		BASS				
Cut Gain(dB)	Boost Gain(dB)	D6	D5	D4	D3	D2
-15.0	15.0	1	1	1	1	0
-14.5	14.5	1	1	1	0	1
-14.0	14.0	1	1	1	0	0
-13.5	13.5	1	1	0	1	1
-13.0	13.0	1	1	0	1	0
-12.5	12.5	1	1	0	0	1
-12.0	12.0	1	1	0	0	0
-11.5	11.5	1	0	1	1	1
-11.0	11.0	1	0	1	1	0
-10.5	10.5	1	0	1	0	1
-10.0	10.0	1	0	1	0	0
-9.5	9.5	1	0	0	1	1
-9.0	9.0	1	0	0	1	0
-8.5	8.5	1	0	0	0	1
-8.0	8.0	1	0	0	0	0
-7.5	7.5	0	1	1	1	1
-7.0	7.0	0	1	1	1	0
-6.5	6.5	0	1	1	0	1
-6.0	6.0	0	1	1	0	0
-5.5	5.5	0	1	0	1	1
-5.0	5.0	0	1	0	1	0
-4.5	4.5	0	1	0	0	1
-4.0	4.0	0	1	0	0	0
-3.5	3.5	0	0	1	1	1
-3.0	3.0	0	0	1	1	0
-2.5	2.5	0	0	1	0	1
-2.0	2.0	0	0	1	0	0
-1.5	1.5	0	0	0	1	1
-1.0	1.0	0	0	0	1	0
-0.5	0.5	0	0	0	0	1
0.0*	0.0*	0	0	0	0	0

* : Default value

■Tone Control(Treble Setting) (Select Address : 04H)

Treble Cut or Boost	BCT
	D7
Cut	0
Boost	1

		TREB				
Cut Gain(dB)	Boost Gain(dB)	D6	D5	D4	D3	D2
-15.0	15.0	1	1	1	1	0
-14.5	14.5	1	1	1	0	1
-14.0	14.0	1	1	1	0	0
-13.5	13.5	1	1	0	1	1
-13.0	13.0	1	1	0	1	0
-12.5	12.5	1	1	0	0	1
-12.0	12.0	1	1	0	0	0
-11.5	11.5	1	0	1	1	1
-11.0	11.0	1	0	1	1	0
-10.5	10.5	1	0	1	0	1
-10.0	10.0	1	0	1	0	0
-9.5	9.5	1	0	0	1	1
-9.0	9.0	1	0	0	1	0
-8.5	8.5	1	0	0	0	1
-8.0	8.0	1	0	0	0	0
-7.5	7.5	0	1	1	1	1
-7.0	7.0	0	1	1	1	0
-6.5	6.5	0	1	1	0	1
-6.0	6.0	0	1	1	0	0
-5.5	5.5	0	1	0	1	1
-5.0	5.0	0	1	0	1	0
-4.5	4.5	0	1	0	0	1
-4.0	4.0	0	1	0	0	0
-3.5	3.5	0	0	1	1	1
-3.0	3.0	0	0	1	1	0
-2.5	2.5	0	0	1	0	1
-2.0	2.0	0	0	1	0	0
-1.5	1.5	0	0	0	1	1
-1.0	1.0	0	0	0	1	0
-0.5	0.5	0	0	0	0	1
0.0*	0.0*	0	0	0	0	0

* : Default value

■ TYPICAL CHARACTERISTICS

fig.1 Supply Current vs Supply Voltage

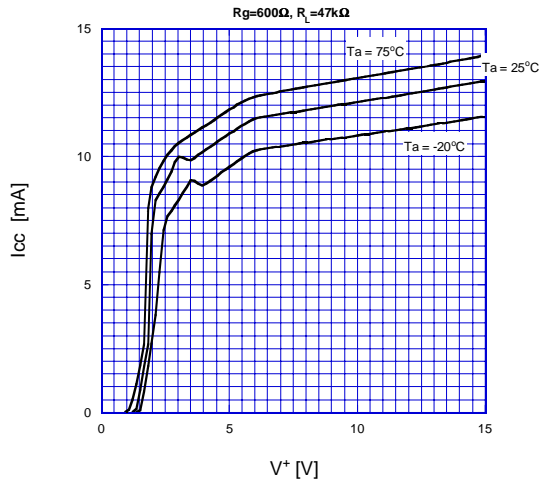

fig.2 Supply Current vs Temperature

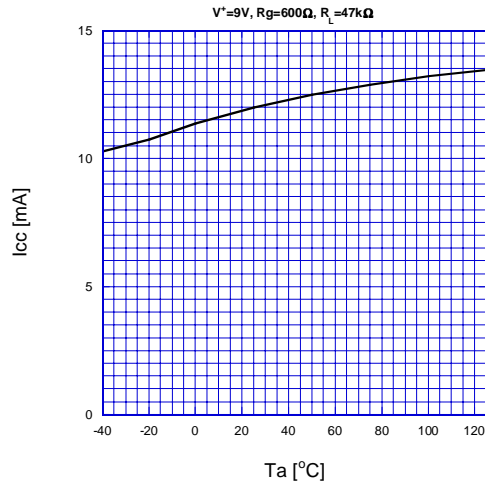

fig.3 Reference Voltage vs Supply Voltage

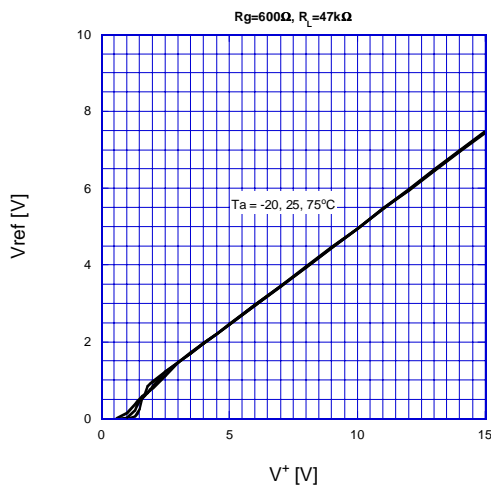

fig.4 Supply Voltage vs Temperature

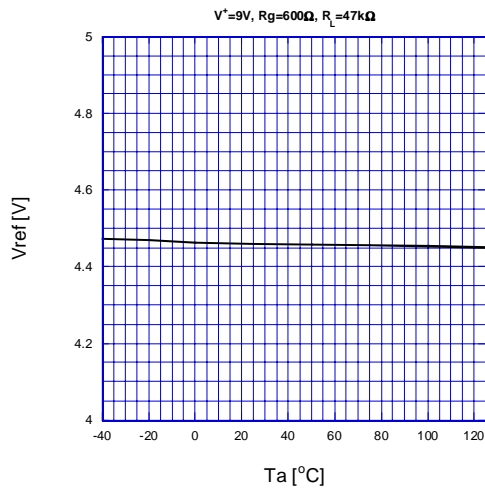

fig.5 Voltage Gain vs Volume Control

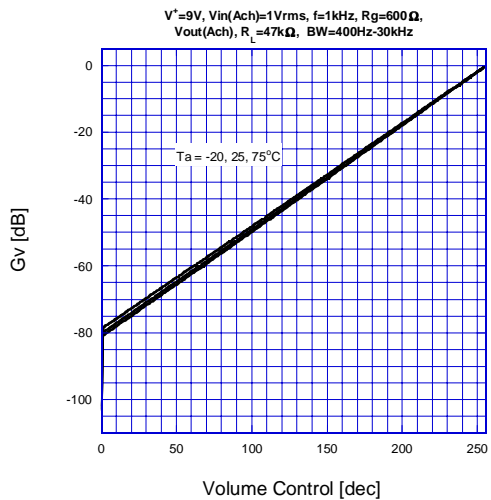
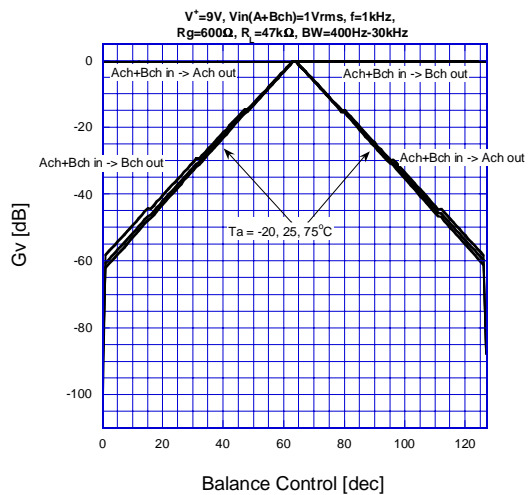

fig.6 Voltage Gain vs Balance Control



TYPICAL CHARACTERISTICS

fig.7 Voltage Gain vs Trimmer Control

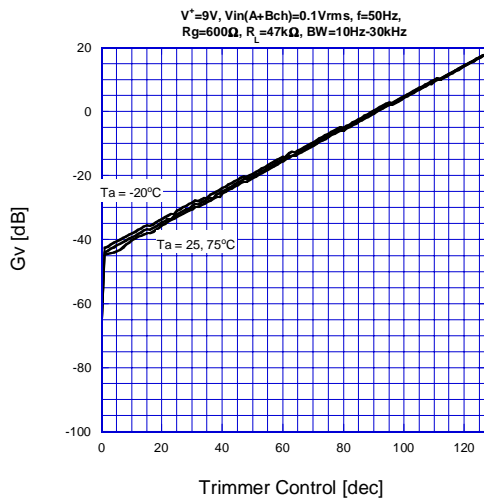

fig.8 THD+N vs Input Voltage (Ach, Bch)

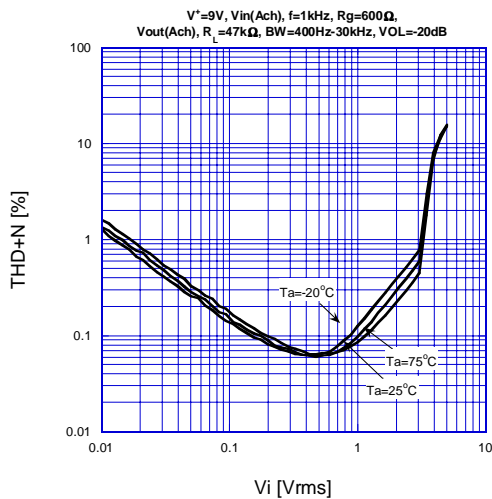

fig.9 THD+N vs Input Voltage (Wch)

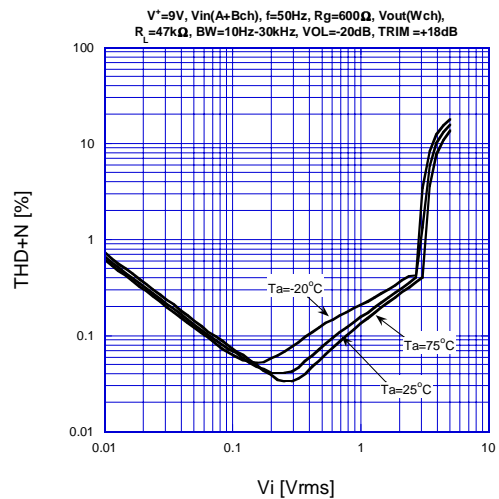

fig.10 THD+N vs Input Voltage (Ach, Bch)

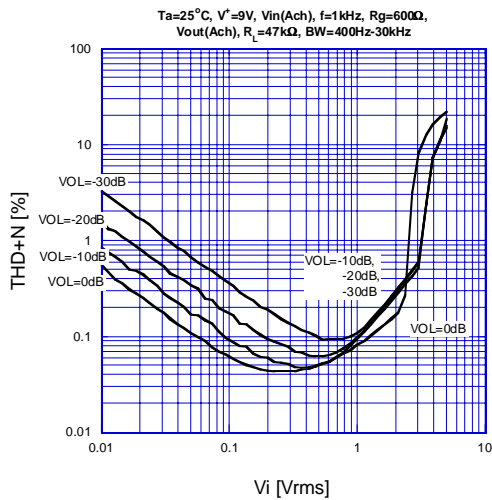
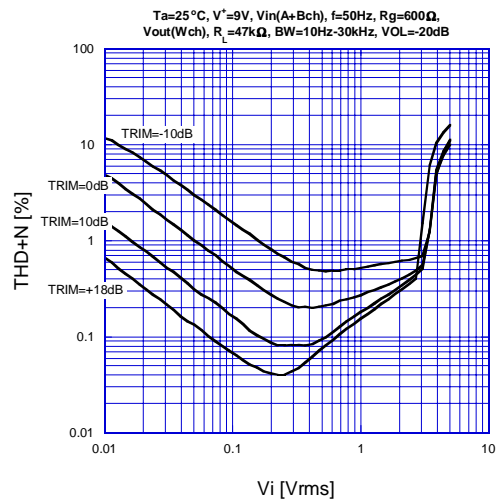

fig.11 THD+N vs Input Voltage (Wch)



■ TYPICAL CHARACTERISTICS

fig.12 THD+N vs Output Voltage (Ach)

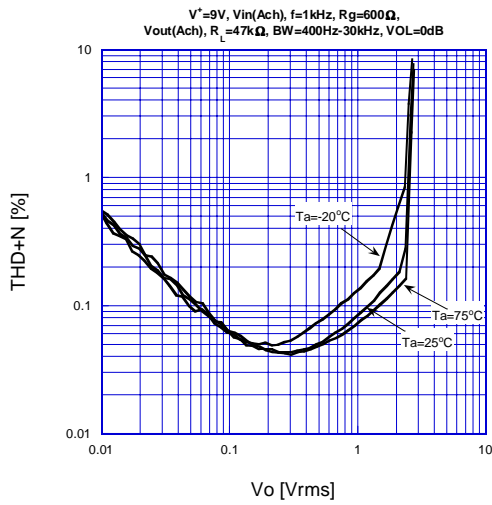

fig.13 THD+N vs Output Voltage (Wch)

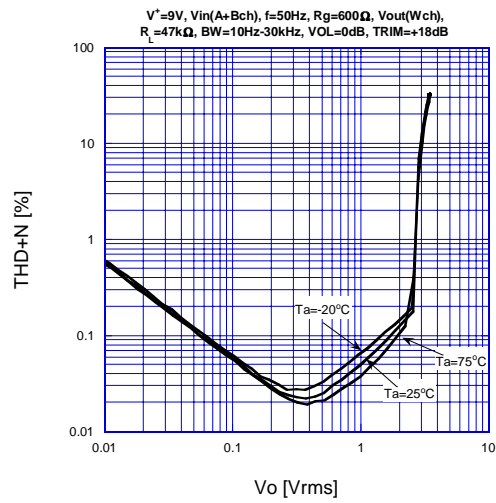

fig.14 AGC Characteristics (Flat level)

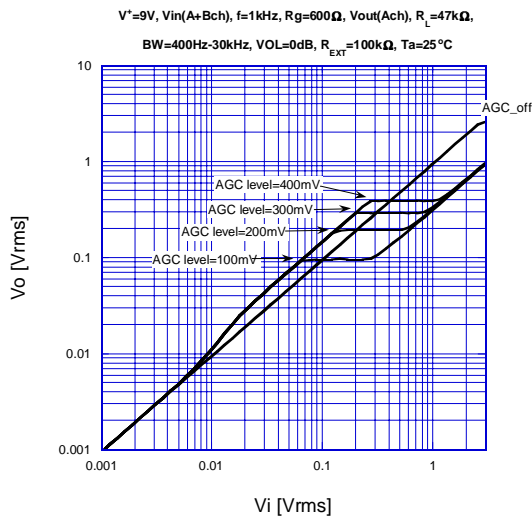

fig.15 AGC Characteristics (R_{EXT})

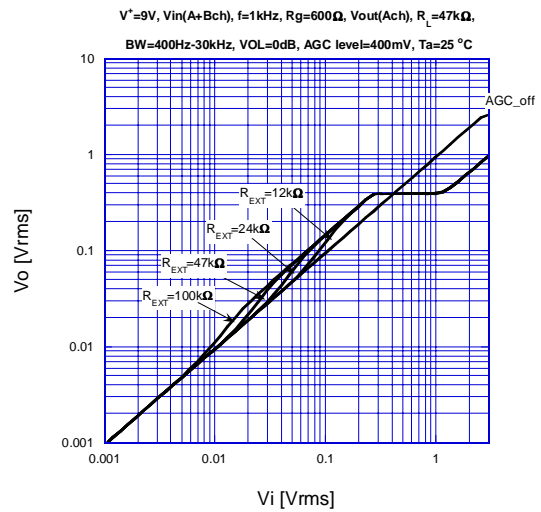
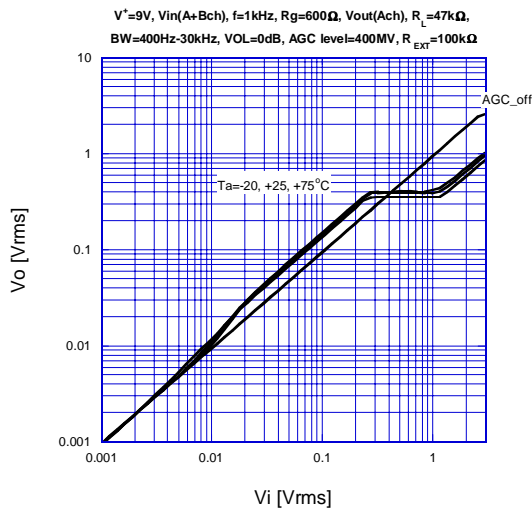

fig.16 AGC Characteristics (T_a)



TYPICAL CHARACTERISTICS

fig.17 AGC Attack Time

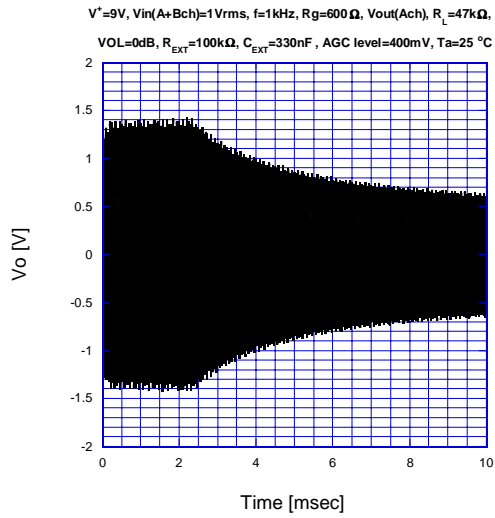

fig.18 AGC Recovery Time

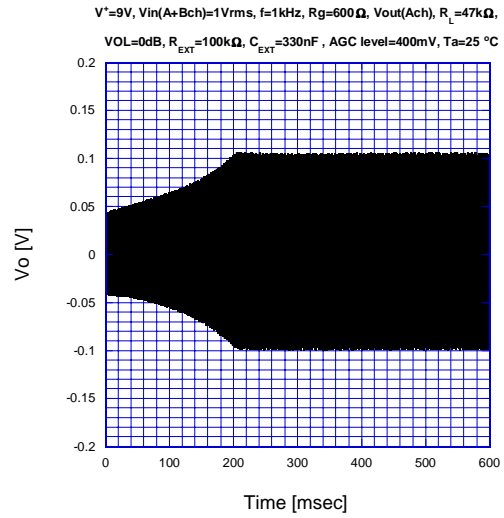

fig.19 Channel Separation vs Frequency (Bch in, Ach out)

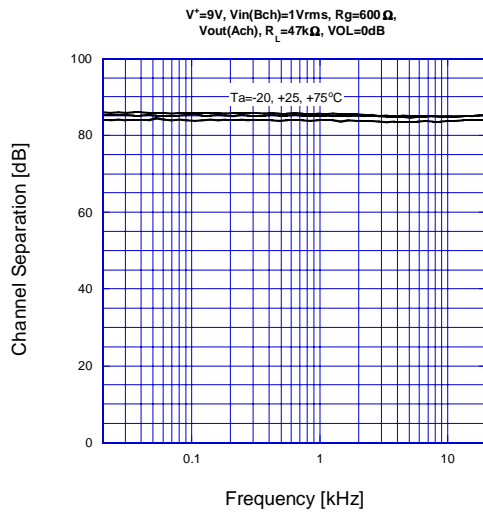

fig.20 Channel Separation vs Frequency (Ach in, Bch out)

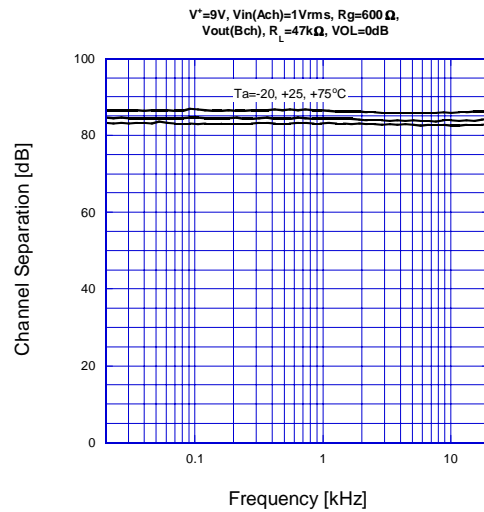

fig.21 MUTE Level vs Frequency

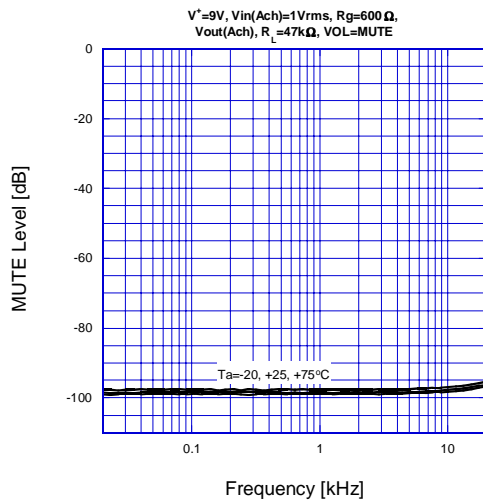
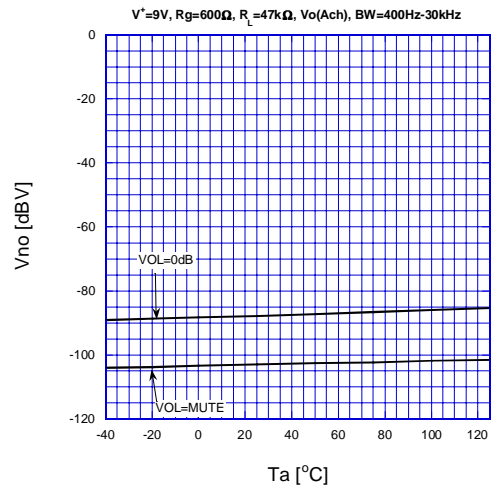

fig.22 Output Noise vs Temperature



■ TYPICAL CHARACTERISTICS

fig.23 Voltage Gain vs Frequency (Trimmer)

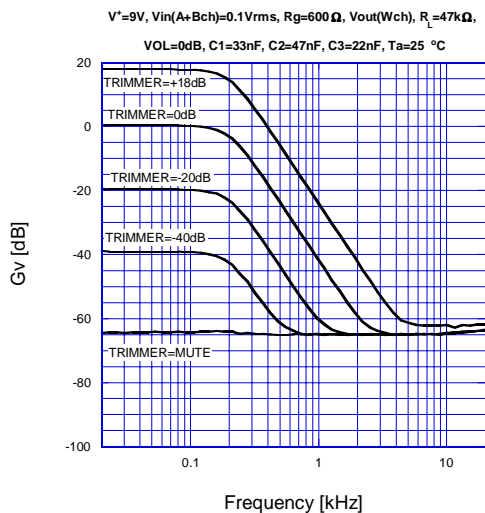

fig.24 Voltage Gain vs Frequency (Trimmer)

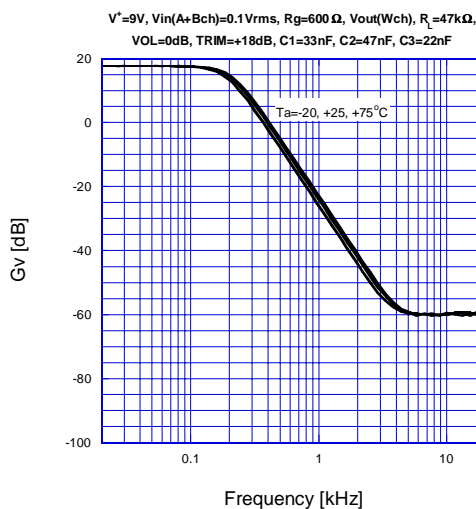

fig.25 LPF Characteristics (C1)

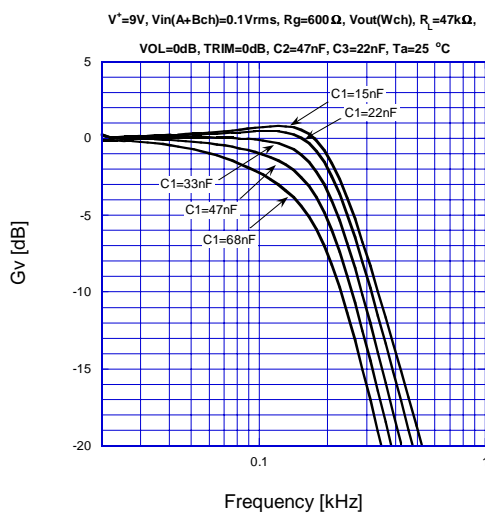

fig.26 LPF Characteristics (C2)

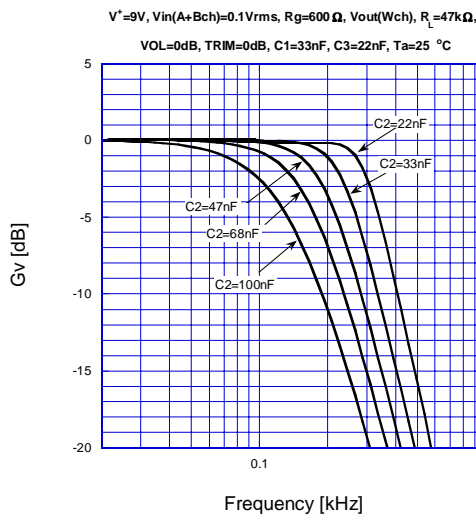
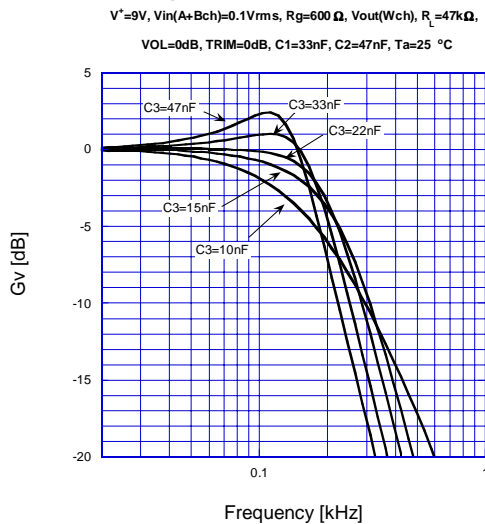

fig.27 LPF Characteristics (C3)



■ TYPICAL CHARACTERISTICS

fig.28 Voltage Gain vs Frequency (Tone)

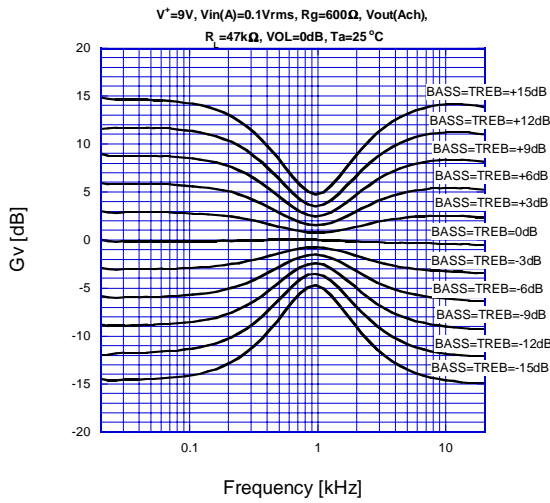

fig.29 Voltage Gain vs Frequency (Tone)

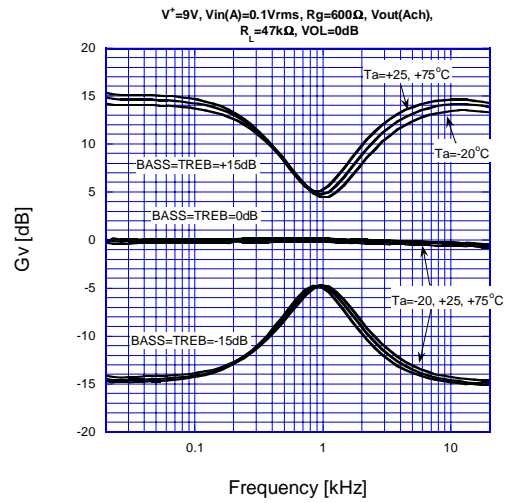

fig.30 Voltage Gain vs Frequency (Sur1)

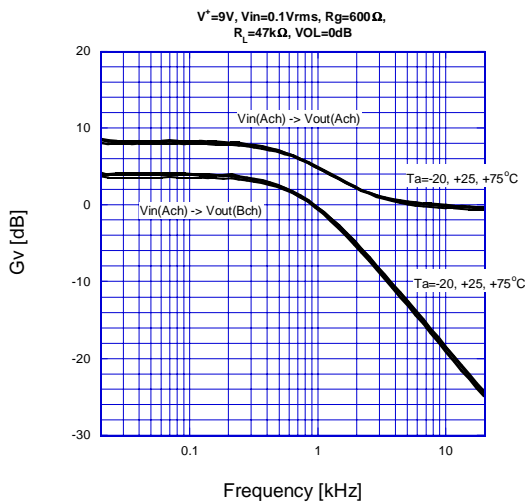

fig.31 Voltage Gain vs Frequency (Sur2)

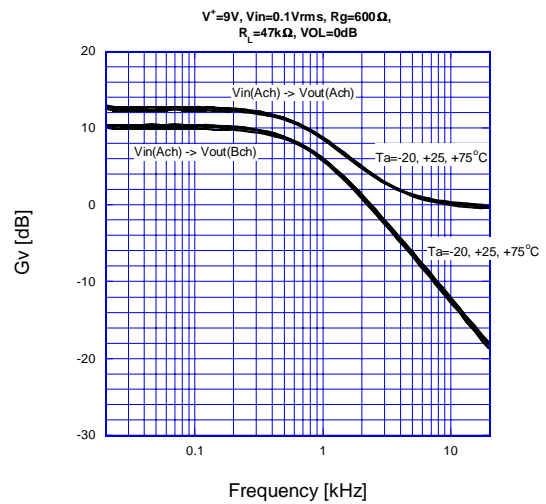

fig.32 Voltage Gain vs Frequency (Simulated Stereo)

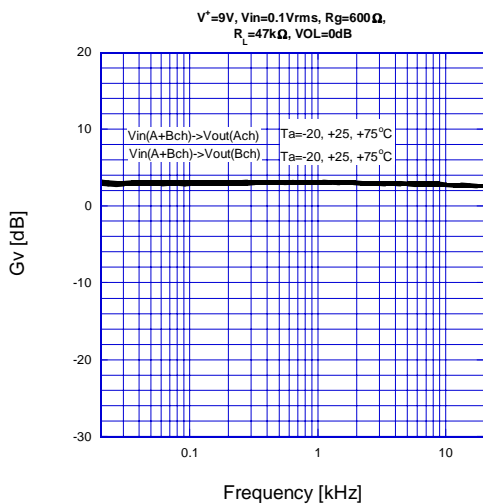
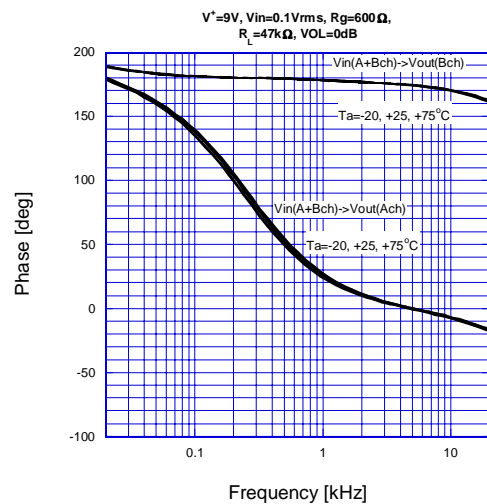

fig.33 Phase vs Frequency (Simulated Stereo)



■NOTE

Purchase of I²C components of New Japan Radio Co., Ltd or one of its sublicensed Associated Companies conveys a license under the Philips I²C Patent Rights to use these components in an I²C system, provided that the system conforms to the I²C Standard Specification as defined by Philips.

[CAUTION]
The specifications on this databook are only given for information, without any guarantee as regards either mistakes or omissions. The application circuits in this databook are described only to show representative usages of the product and not intended for the guarantee or permission of any right including the industrial rights.