

4 INPUT / 1 OUTPUT STEREO AUDIO SELECTOR

■ GENERAL DESCRIPTION

The NJM2750 is 4 Input / 1 Output Stereo Audio Selector. Based on the internal Switch OP-AMP technology, the NJM2750 has lower Output Noise, lower Distortion and higher Channel Separation than the ordinary Multiplexers or Analogue Switches.

The NJM2750 is suitable for any kinds of audio equipments, such as TV, Car Stereo, Mini-Compo and so on.

■ PACKAGE OUTLINE

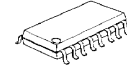

NJM2750M

■ FEATURES

- Operating Voltage (4.7 to 13V)
- 4 Input / 1 Output Audio Selectors
- Dual Channel for Stereo Use
- Low Output Noise (-110dBV typ.)
- Low Distortion (0.005% typ.)
- Bipolar Technology
- Package Outline (DMP16)

■ BLOCK DIAGRAM

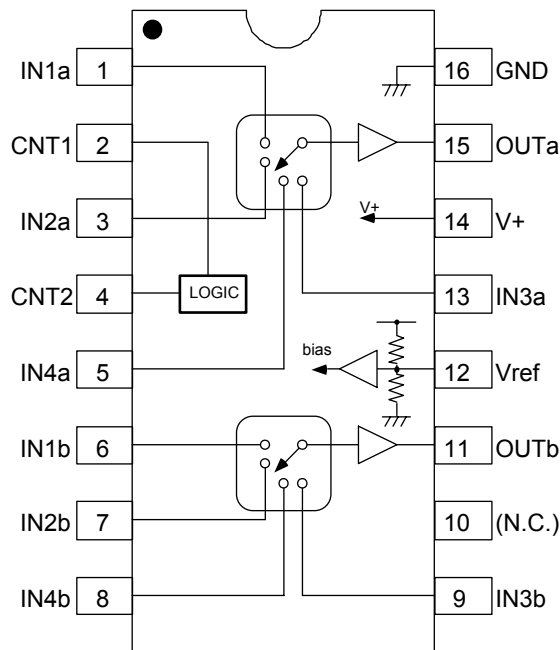

■ PIN CONFIGURATION

PIN No.	SYMBOL	FUNCTION
1	IN1a	Ach INPUT SELECTOR
2	CNT1	CONTROL 1
3	IN2a	Ach INPUT SELECTOR 2
4	CNT2	CONTROL 2
5	IN4a	Ach INPUT SELECTOR 4
6	IN1b	Bch INPUT SELECTOR 1
7	IN2b	Bch INPUT SELECTOR 2
8	IN4b	Bch INPUT SELECTOR 4
9	IN3b	Bch INPUT SELECTOR 3
10	(N.C.)	NO CONNECT
11	OUTb	Bch OUTPUT
12	Vref	REFERENCE VOLTAGE
13	IN3a	Ach INPUT SELECTOR 3
14	V+	POWER SUPPLY
15	OUTa	Ach OUTPUT
16	GND	GROUND

NJM2750

■ ABSOLUTE MAXIMUM RATINGS (Ta=25°C)

PARAMETER	SYMBOL	RATING	UNIT
Supply Voltage	V ⁺	15	V
Power Dissipation	P _D	300	mW
Operating Temperature Range	T _{OPR}	-40 to +85	°C
Storage Temperature Range	T _{STR}	-40 to +125	°C

■ ELECTRICAL CHARACTERISTICS (Ta=25°C, V⁺=9V)

PARAMETER	SYMBOL	TEST CONDITION	MIN.	TYP.	MAX.	UNIT
Operating Voltage	V ⁺		4.7	9.0	13.0	V
Supply Current	I _{CC}	No Signal	-	10	20	mA
Reference Voltage	V _{REF}		-	4.5	-	V
Voltage Gain	G _V	Vin=1Vrms, f=1kHz	-1	0	1	dB
Total Harmonic Distortion	THD+N	Vin=1Vrms, f=1kHz	-	0.005	0.05	%
Output Noise Voltage	V _{NO}	A-Weighted	-	-110 (3)	-100 (10)	dBV (μVrms)
Maximum Output Voltage	V _{OM}	f=1KHz, THD=1%	6 (2.0)	8 (2.5)	-	dBV (Vrms)
Cross Talk	CT	Vin=1Vrms, f=1kHz, A-Weighted	70	90	-	dB
Channel Separation	CS	Vin=1Vrms, f=1kHz, A-Weighted	70	90	-	dB
Switch-ON Voltage Level	V _{CH}		2.4	-	-	V
Switch-OFF Voltage Level	V _{CL}		-	-	0.8	V

■ SWITCH CONTROL LOGIC

CNT2	CNT1	INPUT SELECTOR Ach / Bch
L	L	1
L	H	2
H	L	3
H	H	4

■ TERMINAL DESCRIPTION

PIN No.	SYMBLE	EQUIVALENT CIRCUIT	VOLTAGE	NOTE
1 3 5 6 7 8 9 13	IN1a IN2a IN4a IN1b IN2b IN4b IN3b IN3a		$V+/2$	
2 4	CNT1 CNT2		0V (GND)	
11 15	OUTb OUTa		$V+/2$	
12	Vref		$V+/2$	
14 16	V+ GND		$V+$ 0V	

NJM2750

APPLICATION CIRCUIT

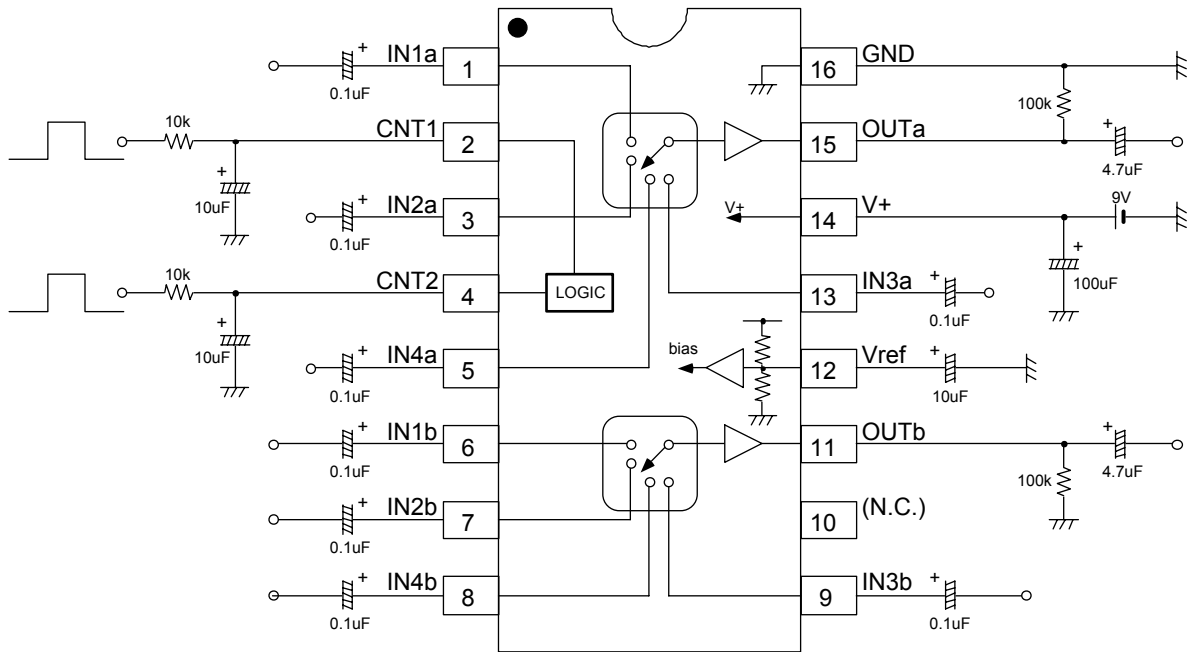

■ TYPICAL CHARACTERISTICS

Supply Current vs Supply Voltage

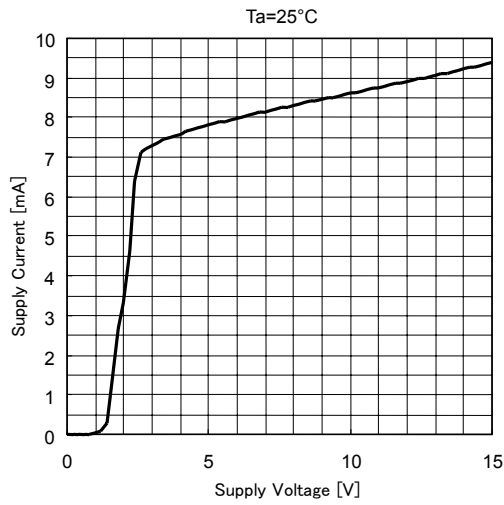

Voltage Gain vs Frequency Response

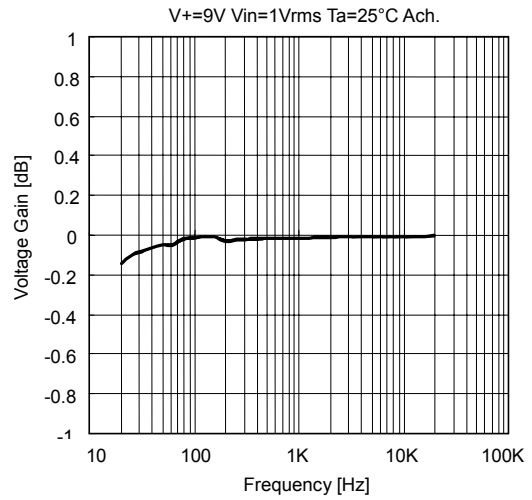

Total Harmonic Distortion vs Input Voltage

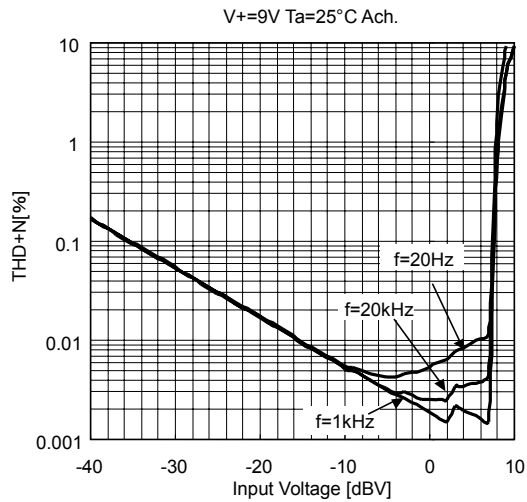

Cross Talk vs Frequency Response

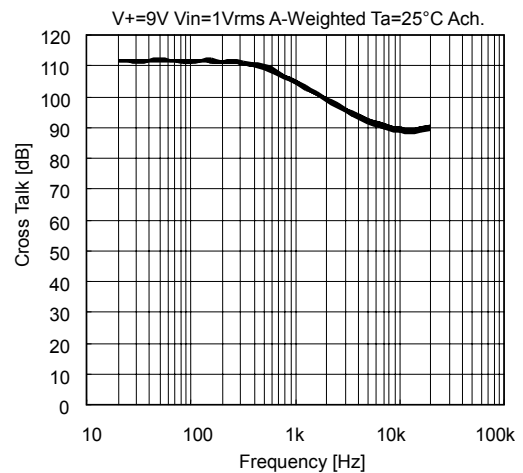

Channel Separation vs Frequency Response

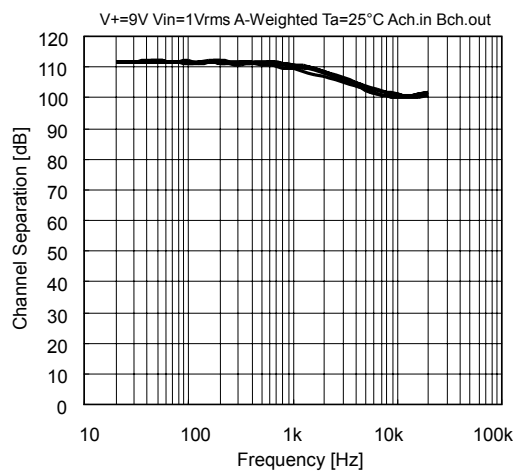

■ TYPICAL CHARACTERISTICS

Supply Current vs Ambient Temperature

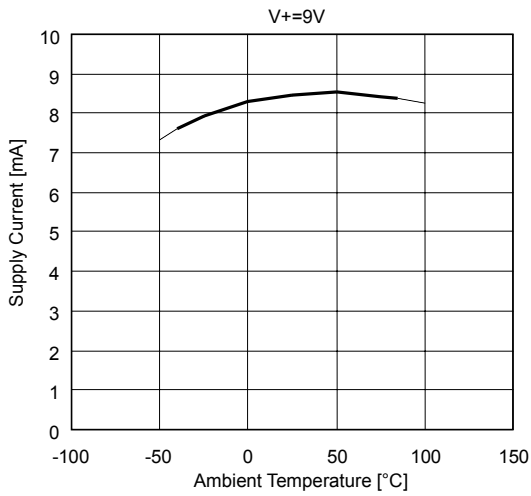

Voltage Gain vs Ambient Temperature

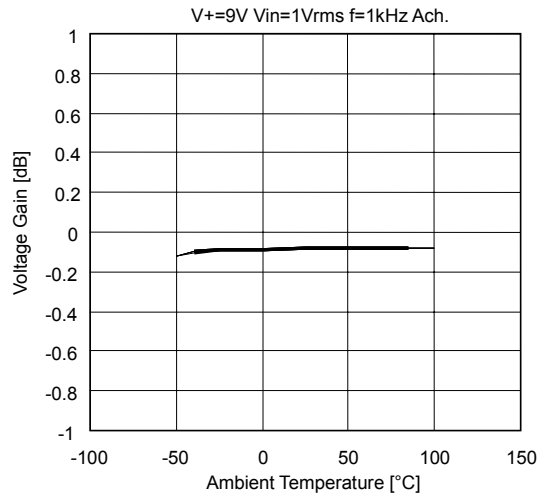

Total Harmonic Distortion vs Ambient Temperature

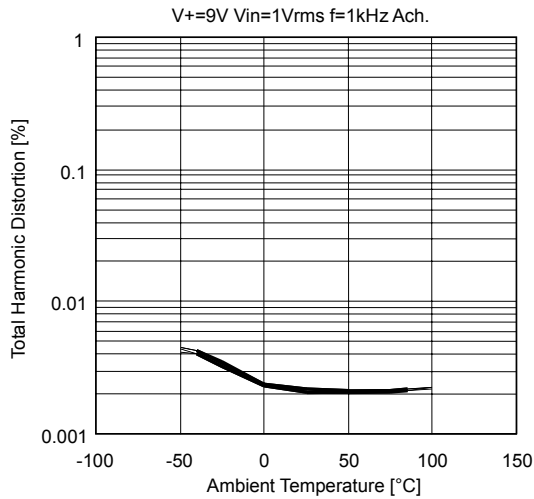

Output Noise Voltage vs Ambient Temperature

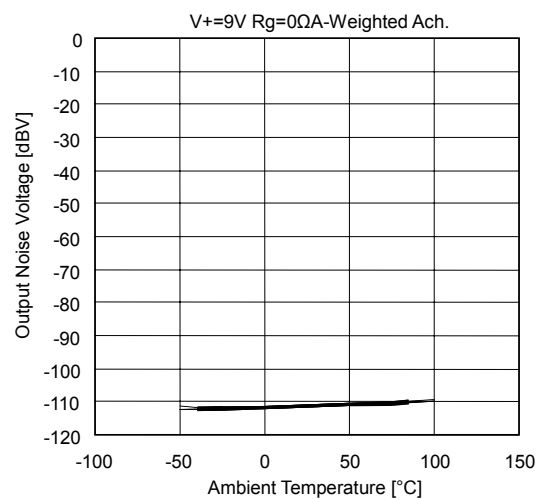

Maximum Output Voltage vs Ambient Temperature

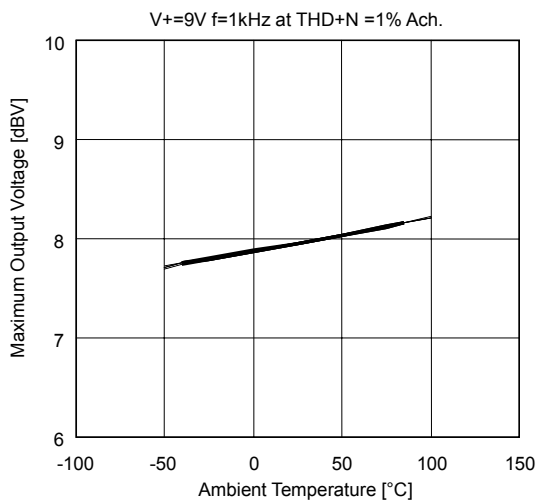

Cross Talk vs Ambient Temperature

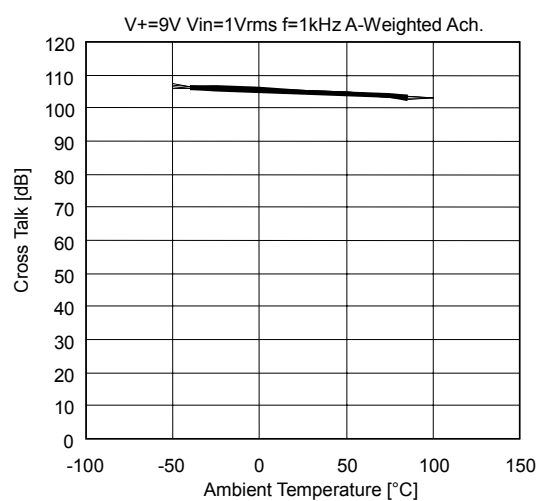

■ TYPICAL CHARACTERISTICS

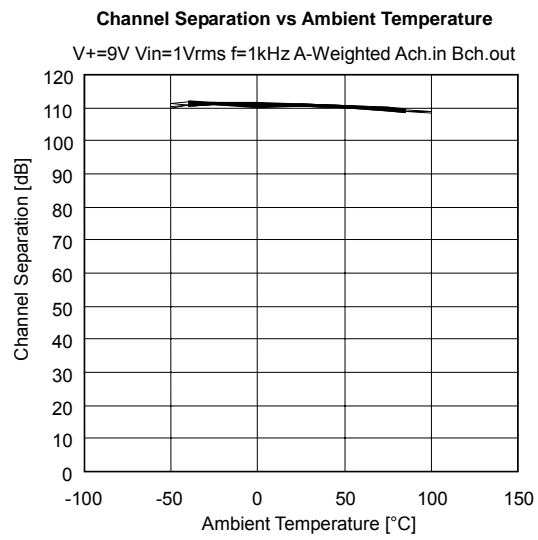

[CAUTION]

The specifications on this databook are only given for information, without any guarantee as regards either mistakes or omissions. The application circuits in this databook are described only to show representative usages of the product and not intended for the guarantee or permission of any right including the industrial rights.