

PDC Dual Band LNA GaAs MMIC

■ GENERAL DESCRIPTION

The NJG1110PB1 is a dual band low noise amplifier (2 input 2 output) GaAs MMIC for 800MHz and 1500MHz band. The band switching between 800MHz and 1500MHz is established by one bit control signal by using built-in inverter circuit.

An ultra small & thin FFP12 (Flip-Chip Fine package) package is adopted.

■ PACKAGE OUTLINE



NJG1110PB1

■ FEATURES

- Low voltage operation +2.8V typ.
- Low current consumption 2.7mA typ.
- Low control current 20uA typ.
- High gain 18dB typ. @f=820MHz
16dB typ. @f=1490MHz
- Low noise figure 1.2dB typ. @f=820MHz
1.1dB typ. @f=1490MHz
- High output IP3 +10dBm typ. @f=820MHz
+13dBm typ. @f=1490MHz
- Ultra small & ultra thin package FFP12-B1 (Package size: 2.0x2.0x0.85mm)

■ PIN CONFIGURATION

PB1 Type
(Top View)

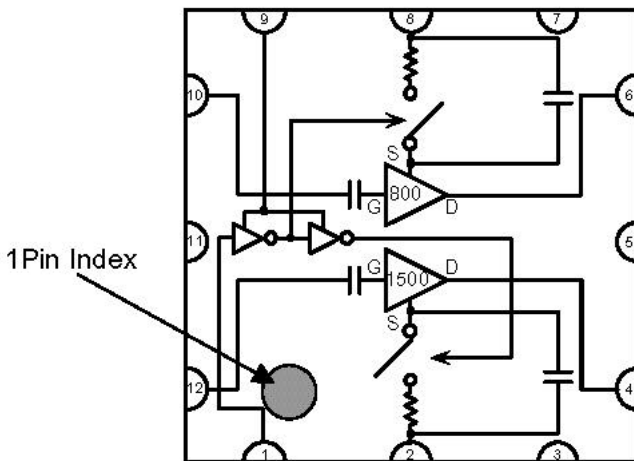

Pin connection

1.VCTL	7.GND
2.GND	8.GND
3.GND	9.VINV
4.RFOUT2	10.RFIN1
5.GND	11.GND
6.RFOUT1	12.RFIN2

Note: The specifications and description listed in this catalog are subject to change without prior notice.

NJG1110PB1

■ ABSOLUTE MAXIMUM RATINGS

($T_a=25^{\circ}\text{C}$, $Z_s=Z_l=50\Omega$)

PARAMETERS	SYMBOL	CONDITIONS	RATINGS	UNITS
Operating voltage	V_{DD}		5.0	V
Control voltage	V_{CTL}		5.0	V
Inverter supply voltage	V_{INV}		5.0	V
Input power	P_{in}	$V_{DD}=2.8\text{V}$	+15	dBm
Power dissipation	P_D		300	mW
Operating temperature	T_{opr}		-40~+85	$^{\circ}\text{C}$
Storage temperature	T_{stg}		-55~+125	$^{\circ}\text{C}$

■ ELECTRICAL CHARACTERISTICS 1 (DC)

($T_a=+25^{\circ}\text{C}$, $Z_s=Z_l=50\Omega$, $V_{DD}=V_{INV}=2.8\text{V}$)

PARAMETERS	SYMBOL	CONDITIONS	MIN	TYP	MAX	UNITS
Operating voltage	V_{DD}		2.5	2.8	4.5	V
Inverter supply voltage	V_{INV}		2.5	2.8	4.5	V
Control voltage (High)	$V_{CTL(H)}$		2.0	2.8	V_{INV}	V
Control voltage (Low)	$V_{CTL(L)}$		0.0	0.0	0.8	V
Operating current	I_{DD}	No RF signal, $V_{CTL}=V_{CTL(L)}$	-	2.7	3.25	mA
		No RF signal, $V_{CTL}=V_{CTL(H)}$	-	2.7	3.25	mA
Control current	I_{CTL}	No RF signal	-	20	60	μA
Inverter current	I_{INV}	No RF signal	-	100	200	μA

■ELECTRICAL CHARACTERISTICS 2 (800MHz BAND RF)

(T_a=+25°C, Z_s=Z_i=50Ω, V_{DD}=V_{INV}=2.8V, V_{CTL}=V_{CTL(L)}, freq=810~885MHz, with application circuit)

PARAMETERS	SYMBOL	CONDITIONS	MIN	TYP	MAX	UNITS
Small signal gain	Gain1		16.0	18.0	19.0	dB
Gain flatness	G _{flat1}	freq=810~830MHz	-	-	0.5	dB
	G _{flat2}	freq=838~843MHz	-	-	0.5	dB
	G _{flat3}	freq=870~885MHz	-	-	0.5	dB
Noise figure	NF1		-	1.2	1.4	dB
Pin at 1dB compression point	P _{-1dB(IN)1}		-21	-18	-	dBm
Output 3rd order intercept point	OIP3_1	f1=freq, f2=freq+100kHz Pin=-35dBm	+6	+10	-	dBm
Isolation	ISL1	freq=680~780MHz	25	30	-	dB
	ISL2	freq=1360~1560MHz	35	45	-	dB
	ISL3	freq=2040~2340MHz	45	55	-	dB
Image suppression ratio	IMR1	freq=582.4~657.4MHz	4	6	-	dB
RF INPUT1 VSWR	VSWR _{i1}		-	-	2.2	-
RF OUTPUT1 VSWR	VSWR _{o1}		-	-	2.0	-

■ELECTRICAL CHARACTERISTICS 3 (1.5GHz BAND RF)

(T_a=+25°C, Z_s=Z_i=50Ω, V_{DD}=V_{INV}=2.8V, V_{CTL}=V_{CTL(H)}, freq=1477~1501MHz, with application circuit)

PARAMETERS	SYMBOL	CONDITIONS	MIN	TYP	MAX	UNITS
Small signal gain	Gain2		15.0	16.0	17.0	dB
Gain flatness	G _{flat4}	freq=1477~1501MHz	-	-	0.5	dB
Noise figure	NF2		-	1.1	1.25	dB
Pin at 1dB compression point	P _{-1dB(IN)2}		-20	-17	-	dBm
Output 3rd order intercept point	OIP3_2	f1=freq, f2=freq+100kHz Pin=-35dBm	+6	+13	-	dBm
Isolation	ISL4	freq=1580~1620MHz	25	30	-	dB
	ISL5	freq=3160~3240MHz	40	50	-	dB
	ISL6	freq=4740~4860MHz	30	40	-	dB
Image suppression ratio	IMR2	freq=1700~1729MHz	3	5	-	dB
RF INPUT2 VSWR	VSWR _{i2}		-	-	2.1	-
RF OUTPUT2 VSWR	VSWR _{o2}		-	-	2.0	-

NJG1110PB1

■ TERMINAL INFORMATION

Pin	Symbol	Description
1	VCTL	Control Voltage terminal to select 800MHz band or 1.5GHz band to select.
2	GND	Ground terminal (0V).
3	GND	Ground terminal (0V).
4	RFOUT2	Output terminal of 1.5GHz band. This terminal is also the power supply terminal of the LNA, please use inductor (L5) to connect power supply. (Please see application circuit.)
5	GND	Ground terminal (0V).
6	RFOUT1	Output terminal of 800MHz band. This terminal is also the power supply terminal of the LNA, please use inductor (L3) to connect power supply. (Please see application circuit.)
7	GND	Ground terminal (0V).
8	GND	Ground terminal (0V).
9	VINV	Power supply terminal of the inverter circuit.
10	RFIN1	Output terminal of 800MHz band. The DC blocking capacitor is not required.
11	GND	Ground terminal (0V).
12	RFIN2	Output terminal of 1.5GHz band. The DC blocking capacitor is not required.

NOTE:

- 1) Ground terminal (2, 3, 5, 8, 11pin) should be connected to ground plane by multiple via holes for good grounding.
- 2) Please connect bypass capacitors possible close to inductors (L3, L5)..

■ TYPICAL CHARACTERISTICS (800MHz Band)

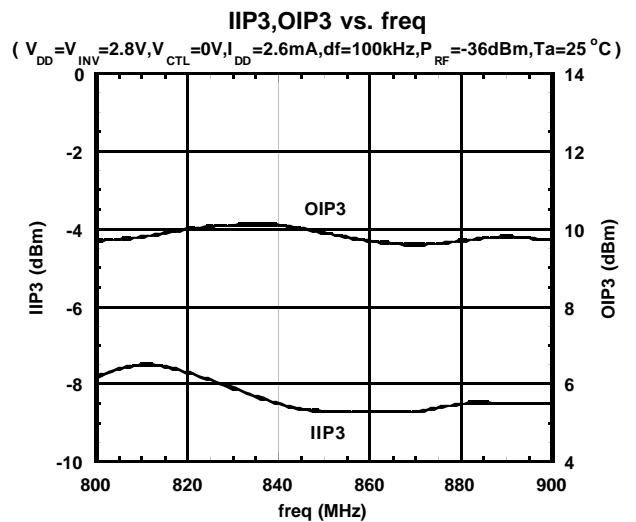
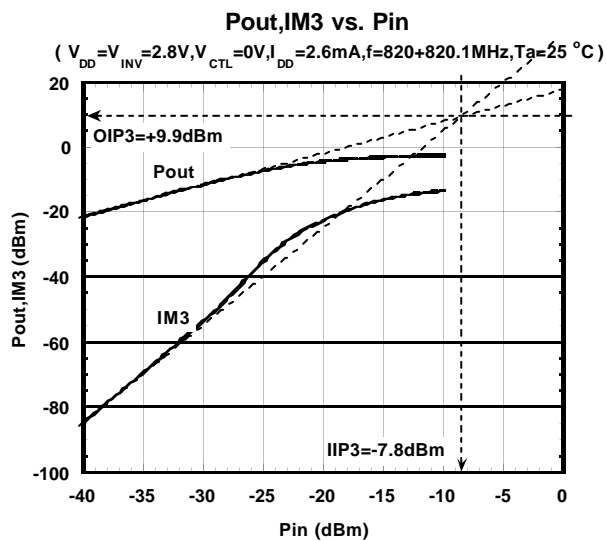
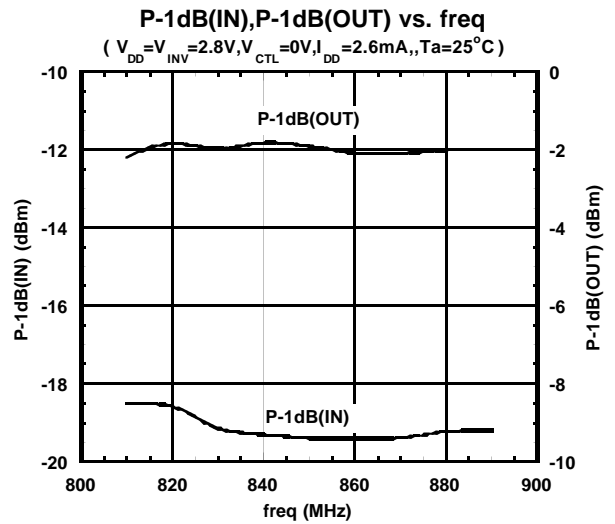
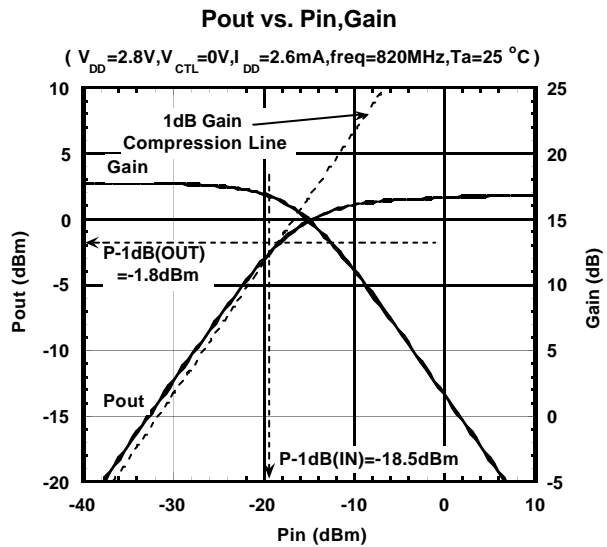
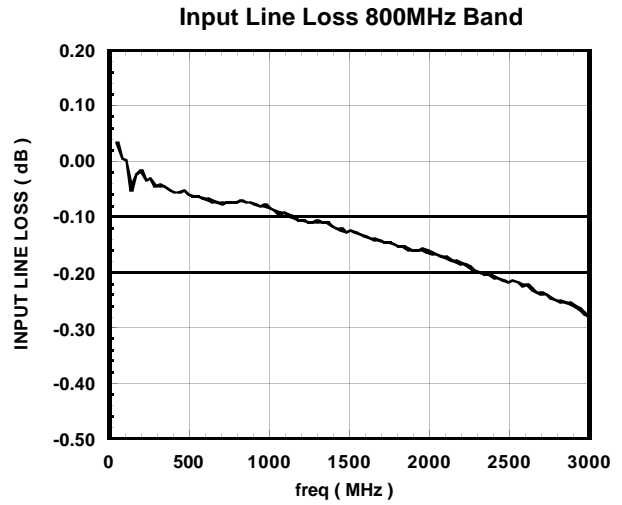
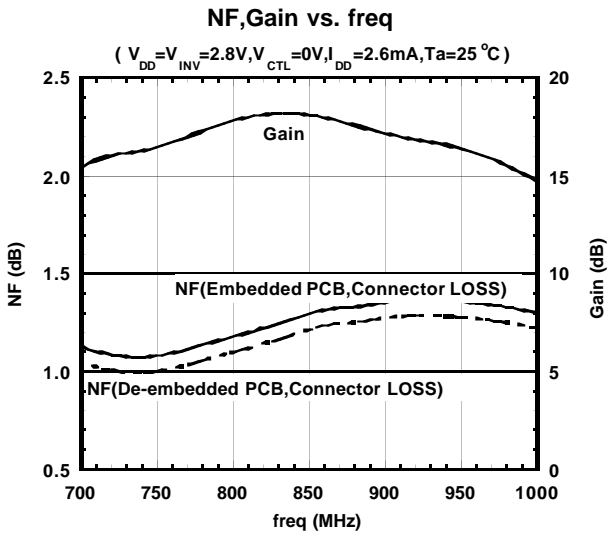

NJG1110PB1

■ TYPICAL CHARACTERISTICS (800MHz Band)

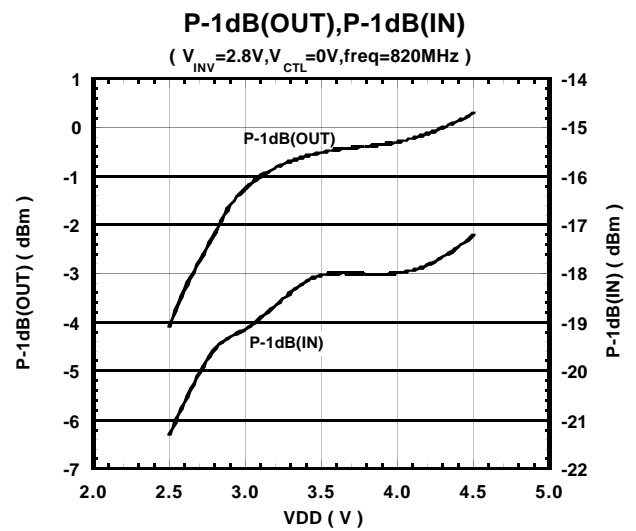
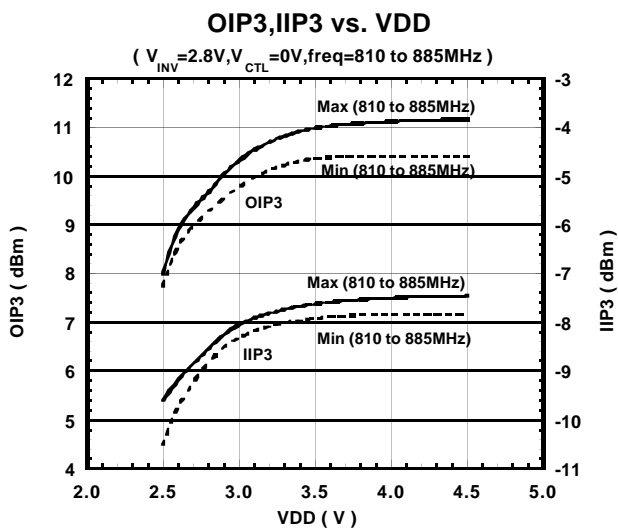
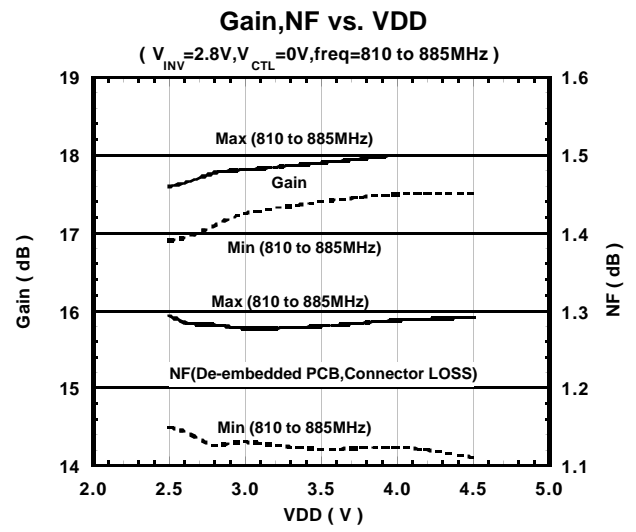
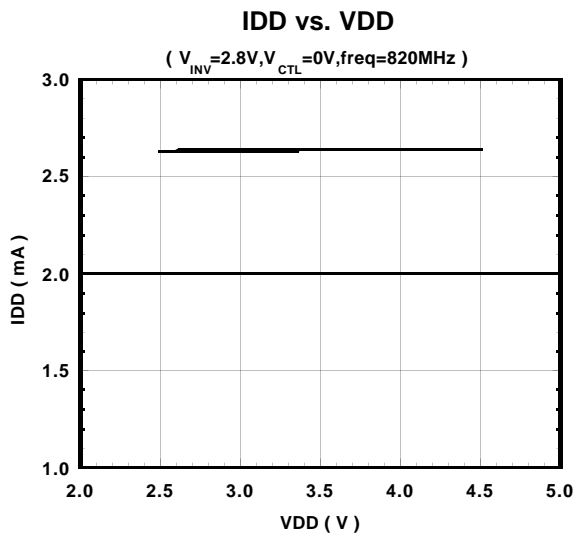

■ TYPICAL CHARACTERISTICS (800MHz Band)

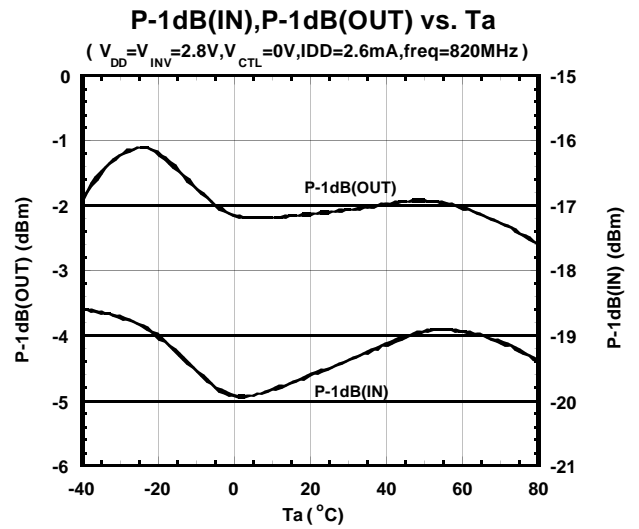
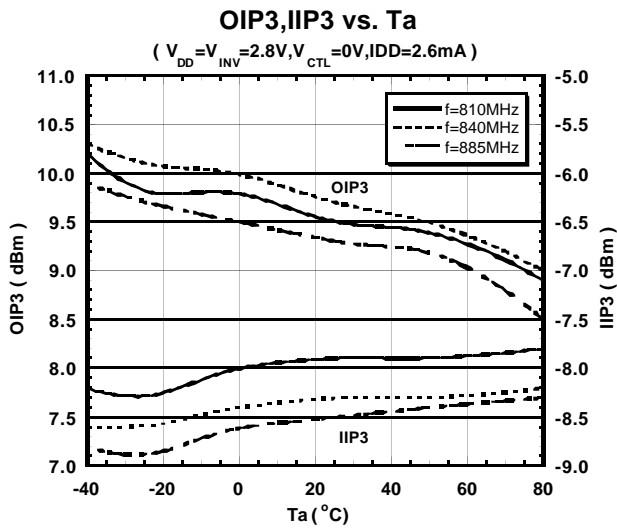
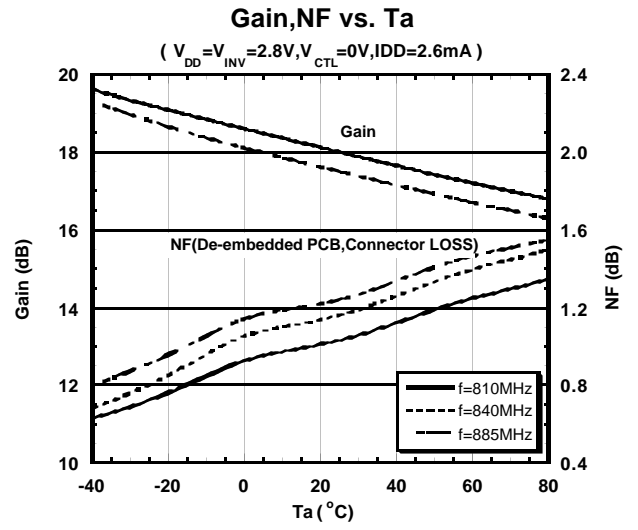
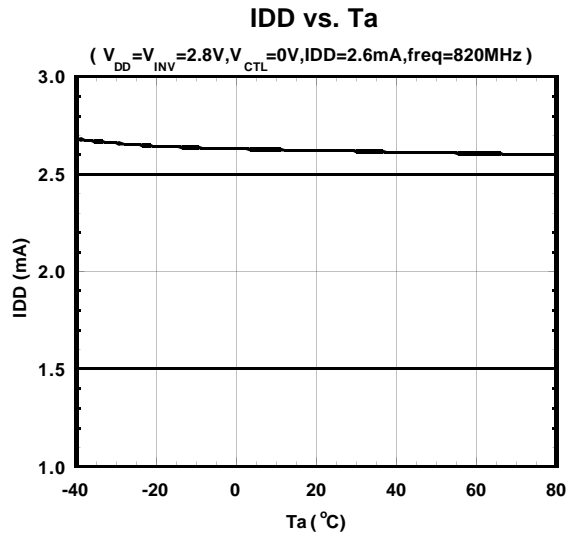

NJG1110PB1

■ TYPICAL CHARACTERISTICS (800MHz Band)

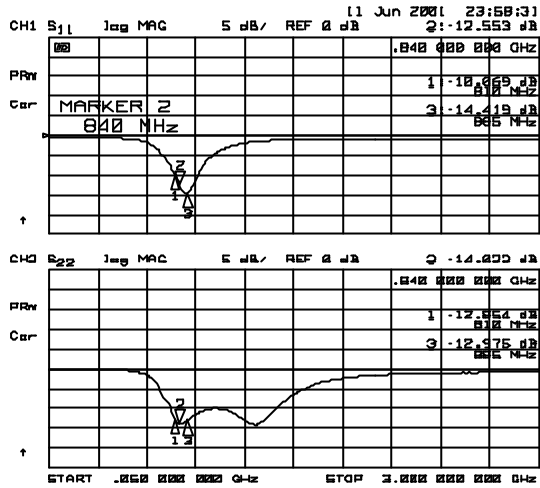

S11, S22

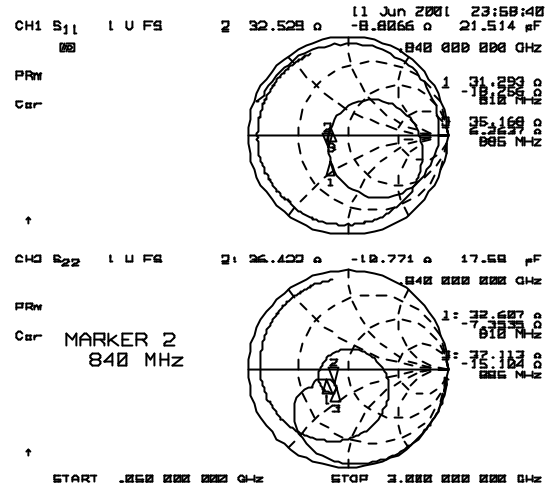

Zin, Zout

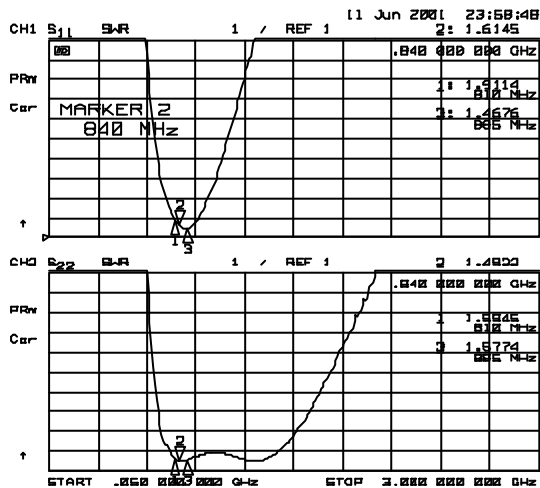

VSWR

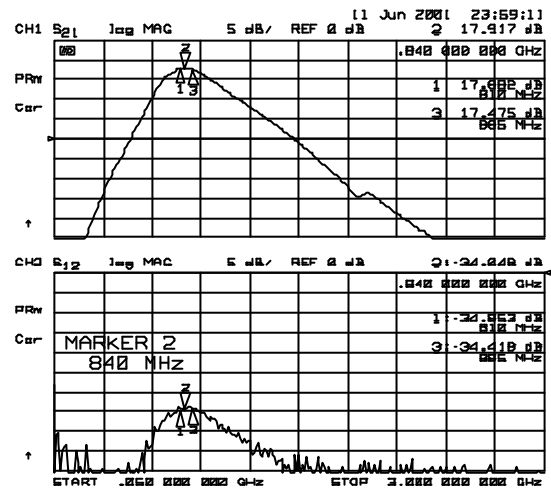

S21, 12

■ TYPICAL CHARACTERISTICS (800MHz Band)

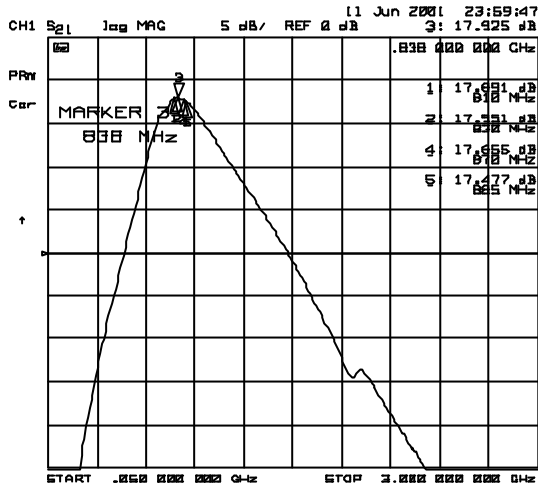

S21

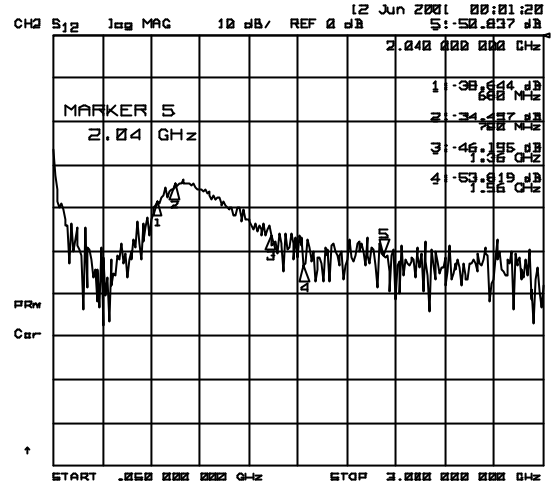

S12

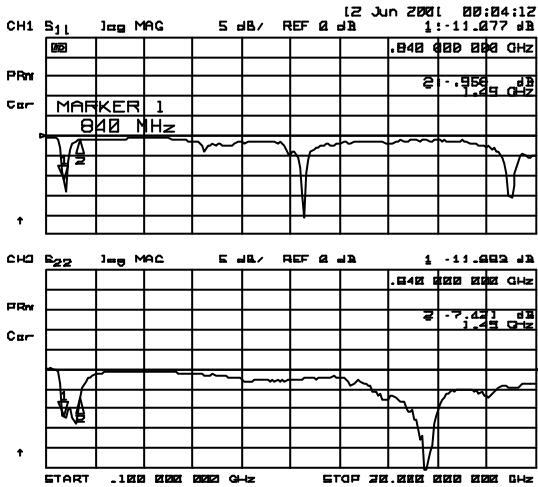

S11, S22

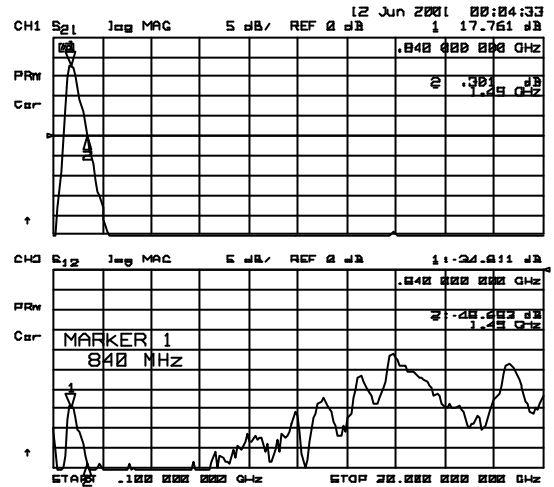

S21, S12

NJG1110PB1

■ TYPICAL CHARACTERISTICS (1.5GHz Band)

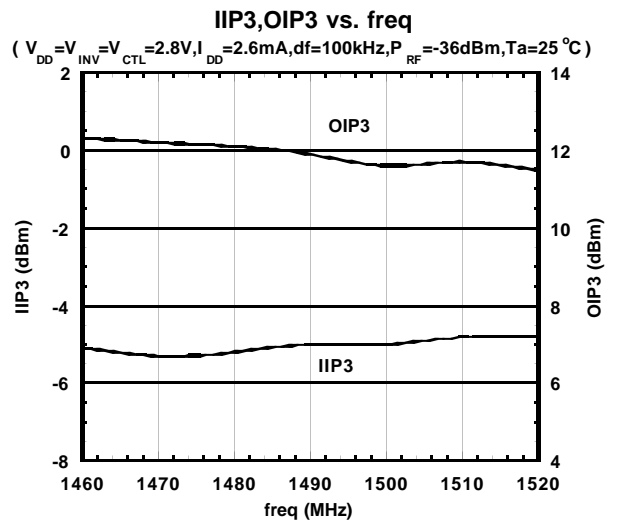
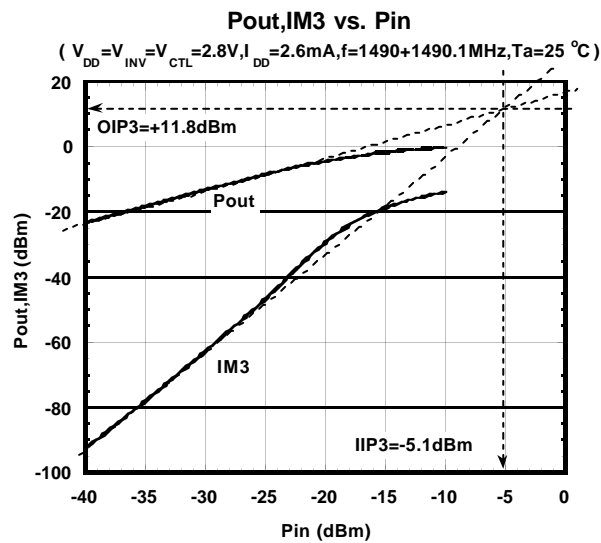
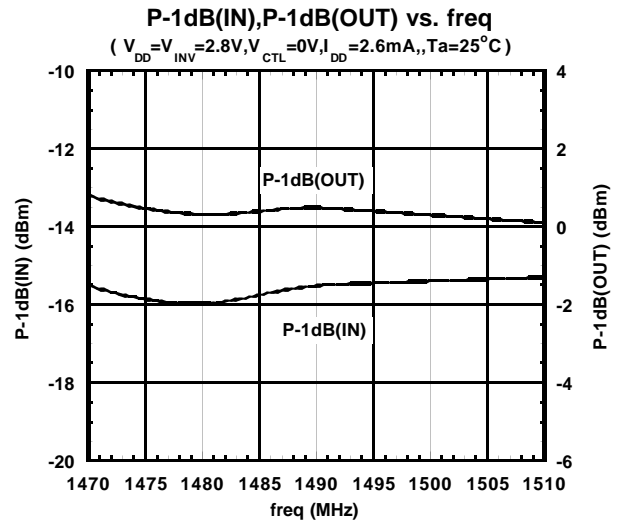
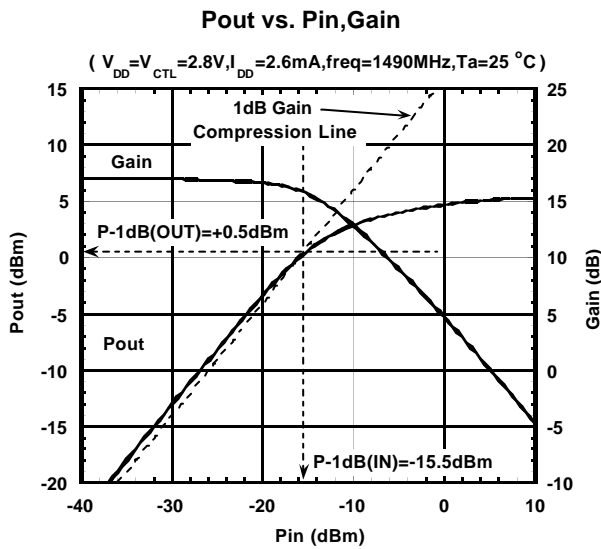
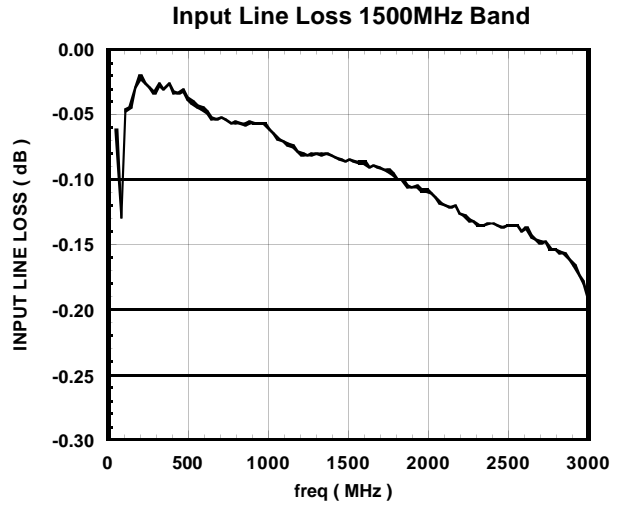
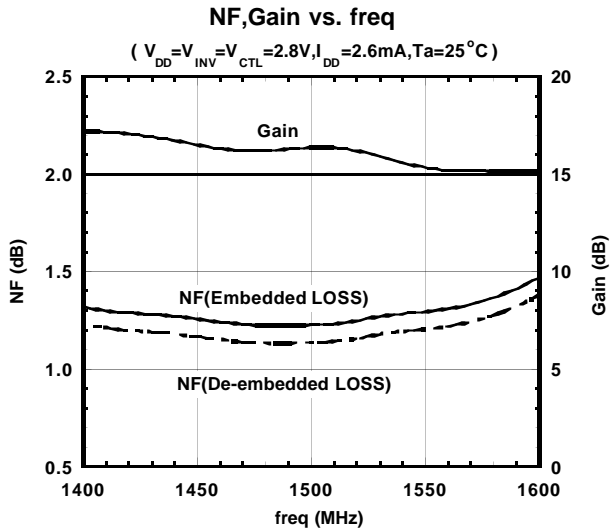

■ TYPICAL CHARACTERISTICS (1.5GHz Band)

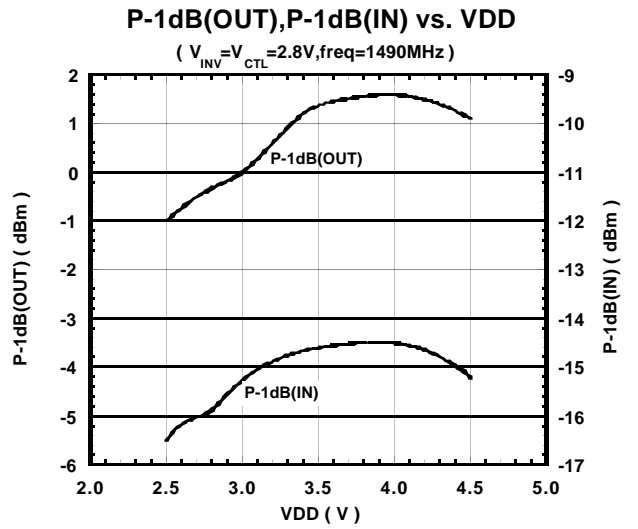
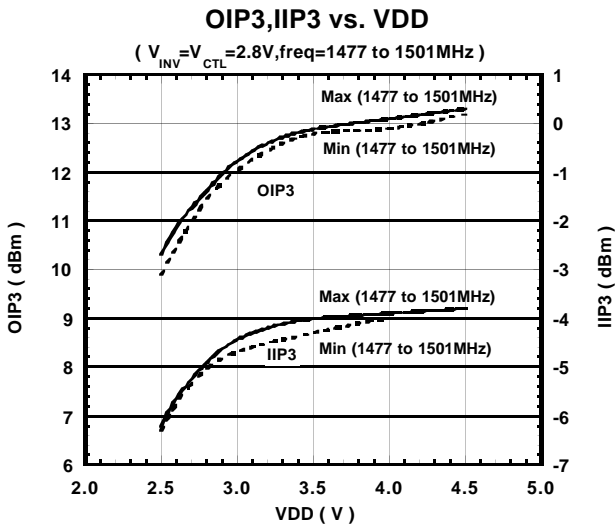
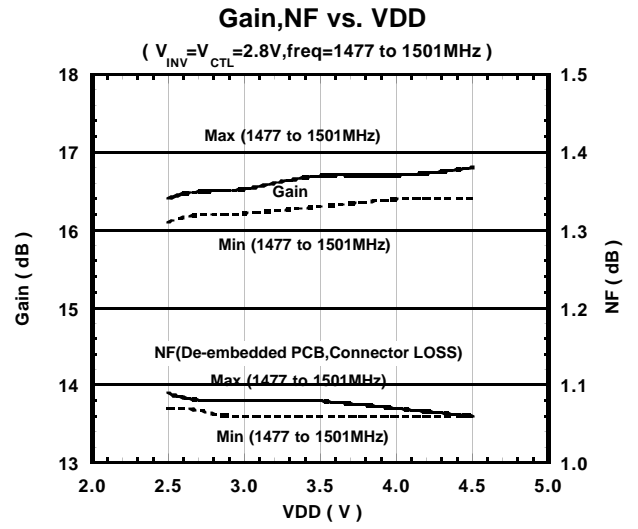
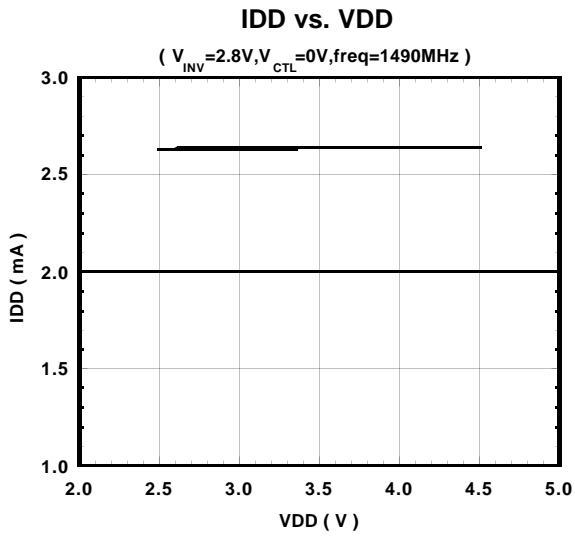

NJG1110PB1

■ TYPICAL CHARACTERISTICS (1.5GHz Band)

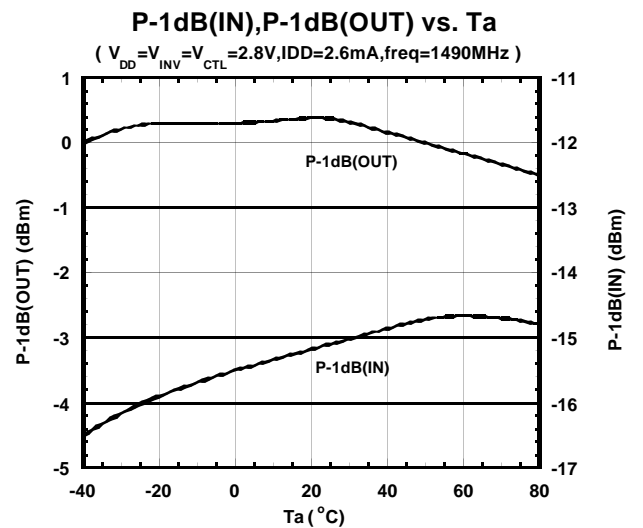
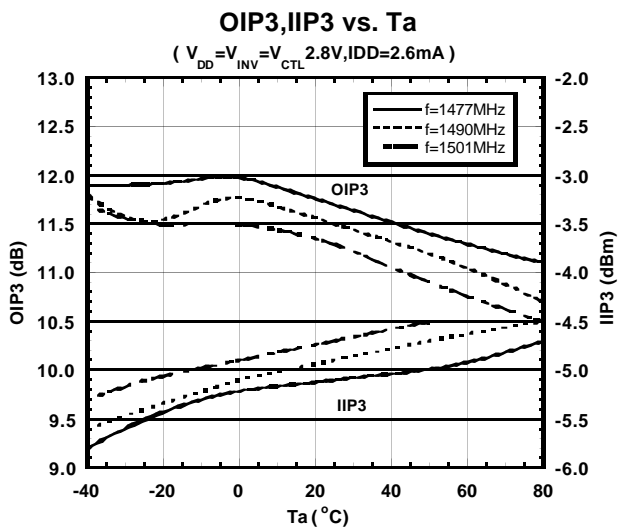
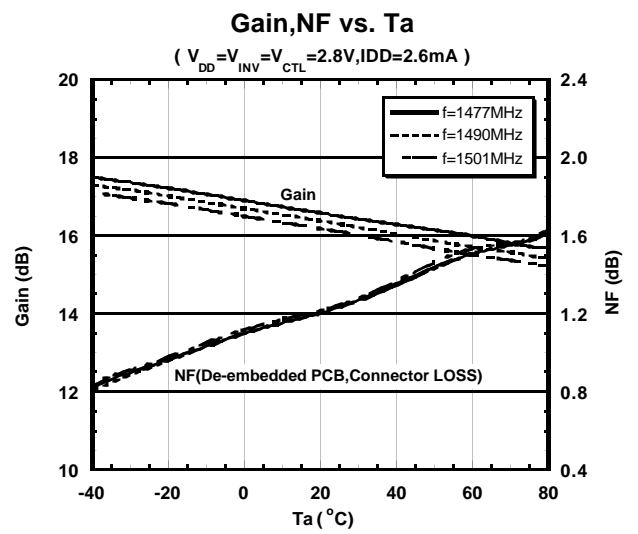
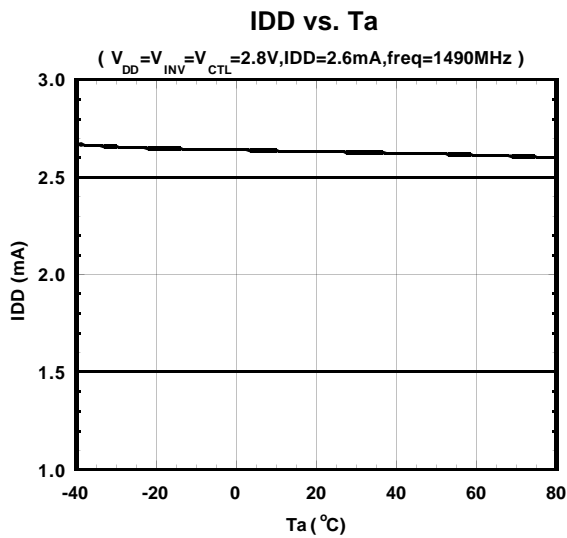

■ TYPICAL CHARACTERISTICS (1.5GHz Band)

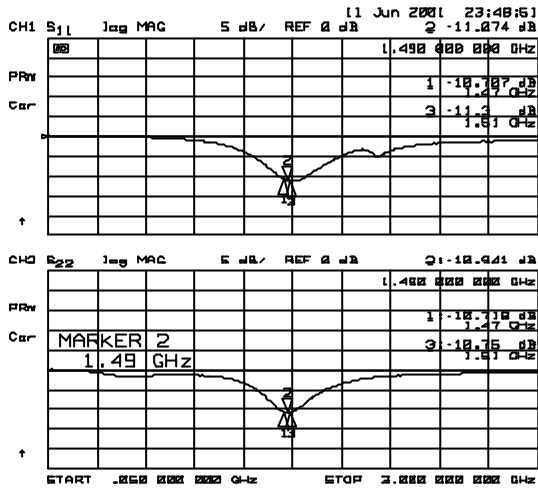

S11, S22

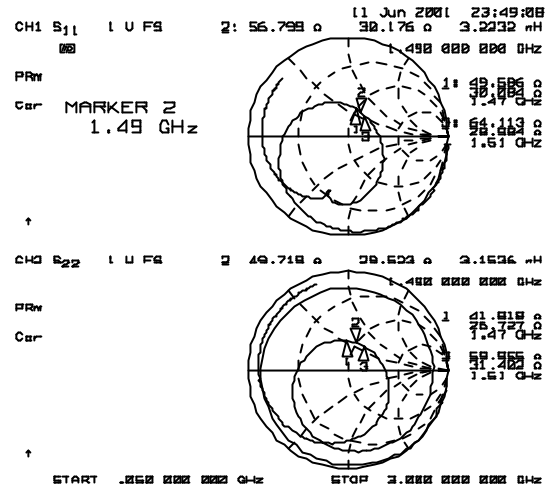

Zin, Zout

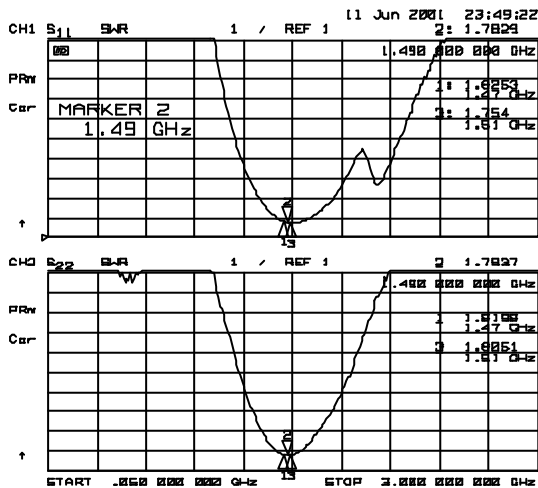

VSWR

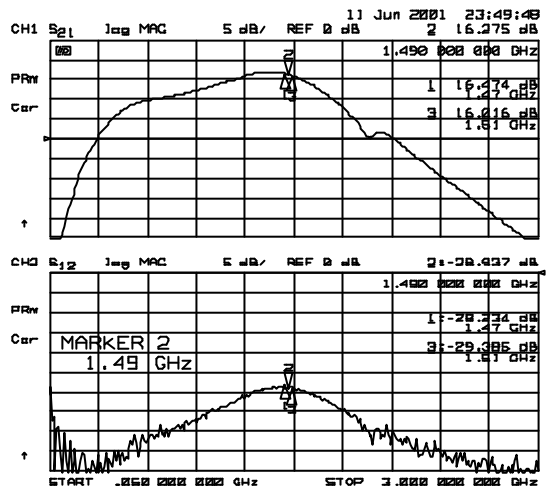

S21, 12

NJG1110PB1

■ TYPICAL CHARACTERISTICS (1.5GHz Band)

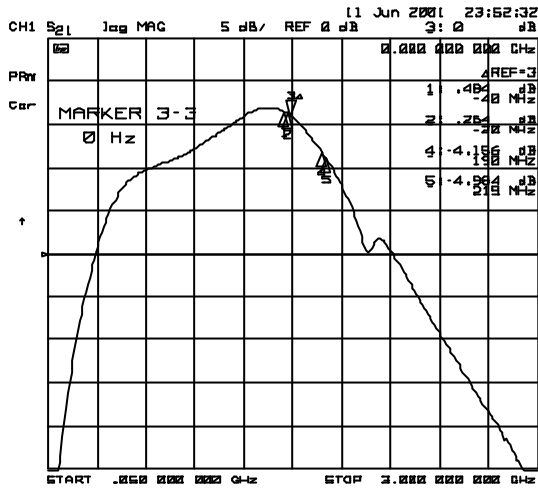

S21

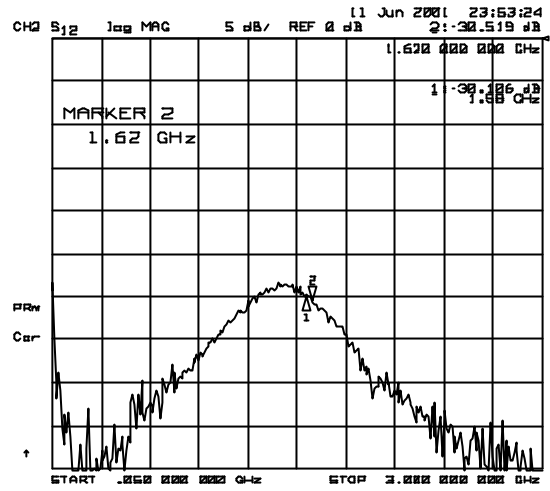

S12

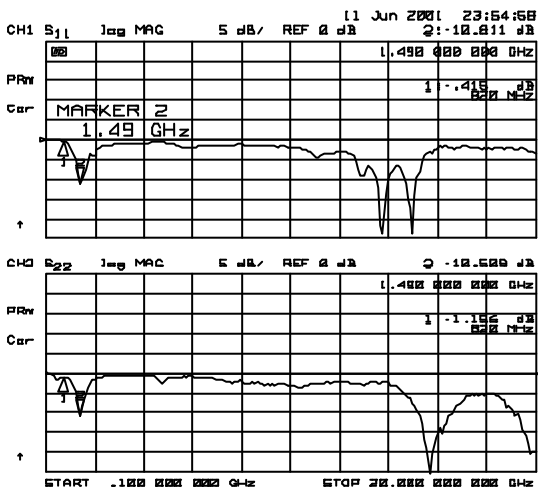

S11, S22

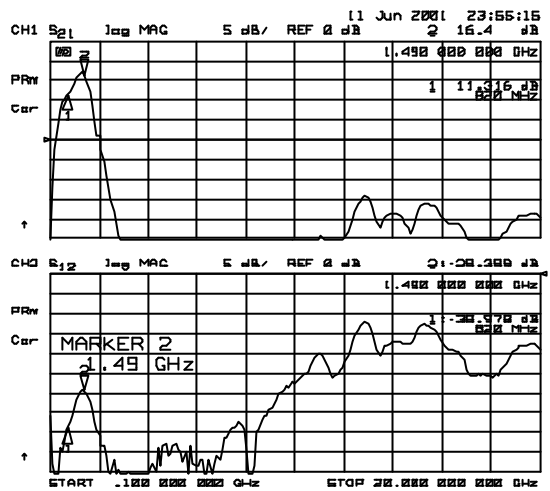

S21, S12

APPLICATION CIRCUIT

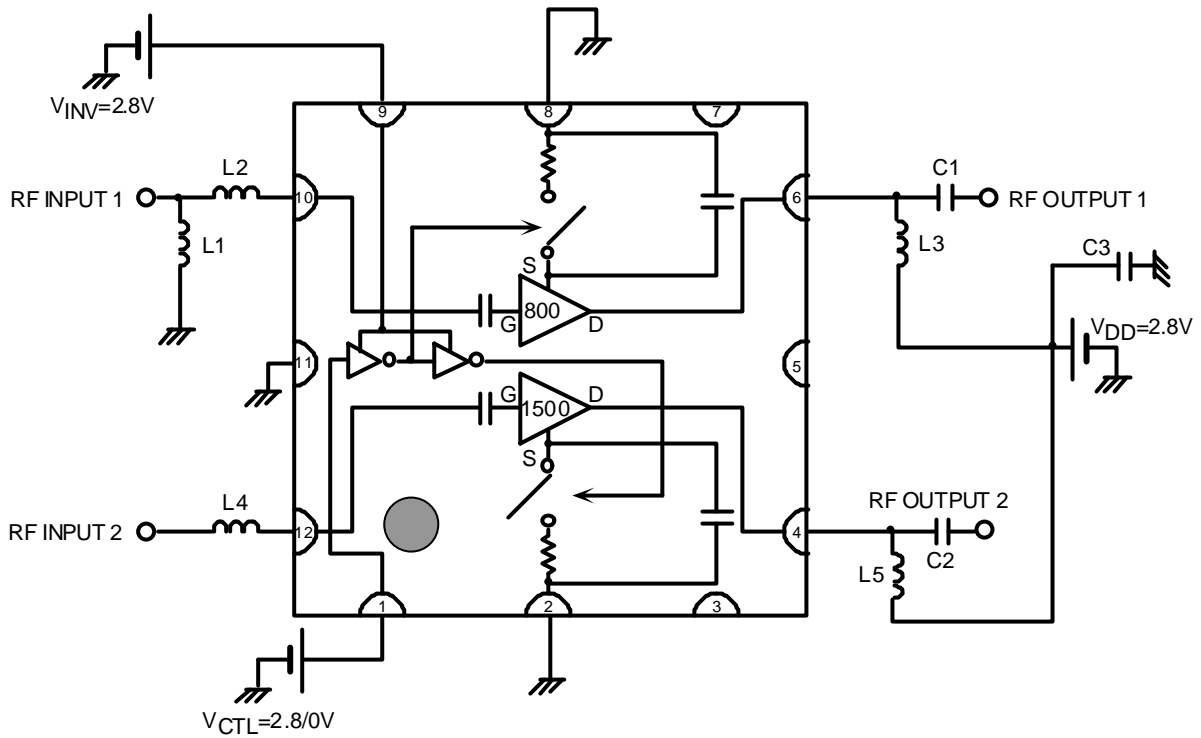

PARTS LIST

Parts ID	CONSTANT	COMMENT
L1	22nH	TAIYO-YUDEN (HK1005, 1005size)
L2	27nH	MEC (ELJNJ, 1608size)
L3	10nH	TAIYO-YUDEN (HK1005, 1005size)
L4	12nH	TAIYO-YUDEN (HK1005, 1005size)
L5	15nH	TAIYO-YUDEN (HK1005, 1005size)
C1	2pF	MURATA (GRM36, 1005size)
C2	6pF	MURATA (GRM36, 1005size)
C3	1000pF	MURATA (GRM36, 1005size)

*: Please use an appropriate inductor for L2 to improve Noise Figure.

NJG1110PB1

RECOMMENDED PCB DESIGN

(Top View)

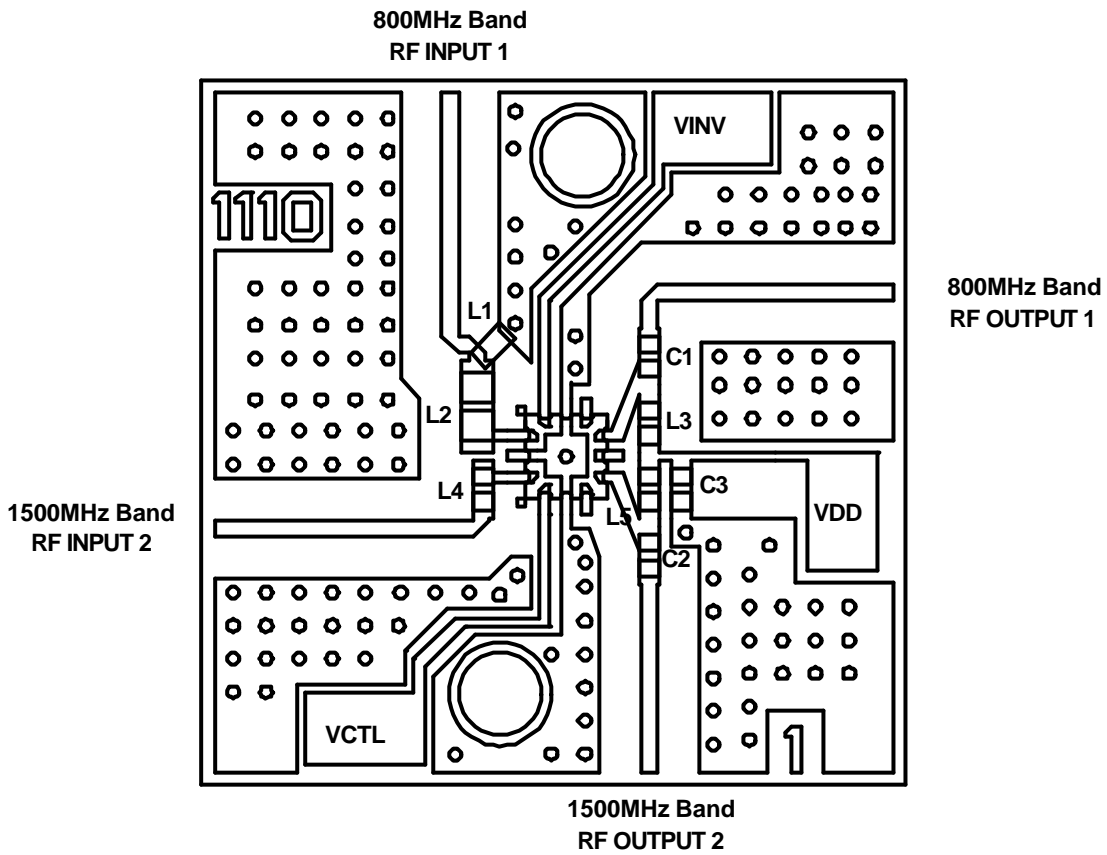

PCB (FR-4): t=0.2mm

MICROSTRIP LINE WIDTH=0.4mm ($Z_0=50\Omega$)

PCB SIZE=17x17mm

PRECAUTIONS

- [1] Please locate L2, L4, L3, and L5 close to IC.
- [2] Please locate C3 close to L3, L5.
- [3] Please layout each parts as close as possible.

PACKAGE OUTLINE (FFP12-B1)

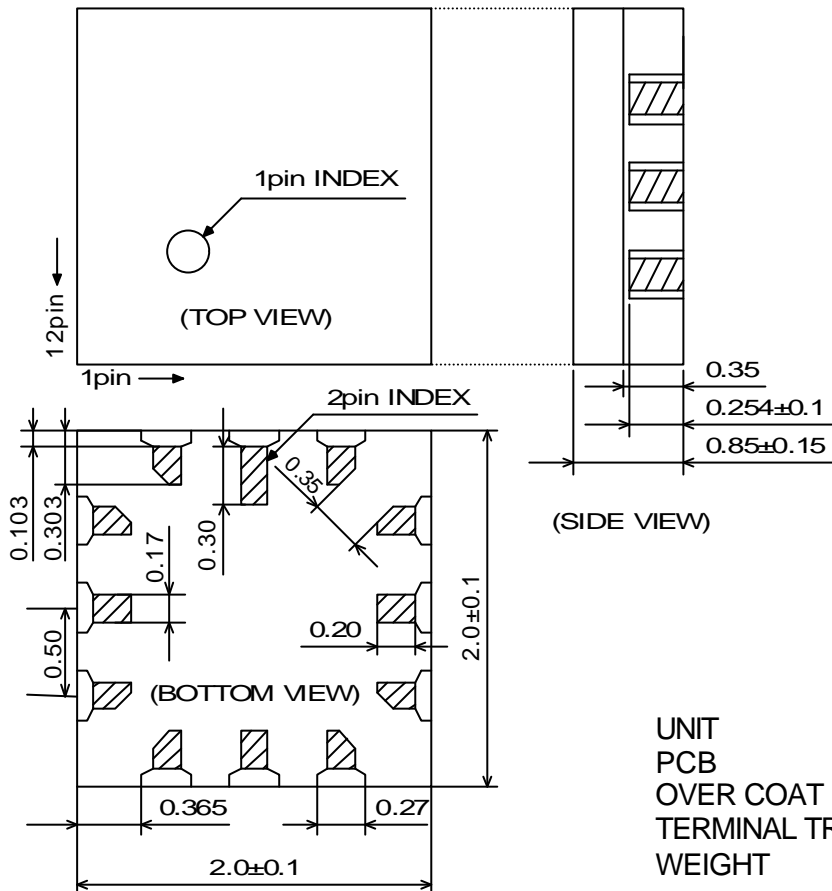

UNIT	: mm
PCB	: Ceramic
OVER COAT	: Epoxy resin
TERMINAL TREAT	: Au
WEIGHT	: 10mg

Cautions on using this product

This product contains Gallium-Arsenide (GaAs) which is a harmful material.

- Do NOT eat or put into mouth.
- Do NOT dispose in fire or break up this product.
- Do NOT chemically make gas or powder with this product.
- To waste this product, please obey the relating law of your country.

[CAUTION]

The specifications on this databook are only given for information, without any guarantee as regards either mistakes or omissions. The application circuits in this databook are described only to show representative usages of the product and not intended for the guarantee or permission of any right including the industrial rights.

This product may be damaged with electric static discharge (ESD) or spike voltage. Please handle with care to avoid these damages.