

SPDT SWITCH GaAs MMIC

■GENERAL DESCRIPTION

NJG1509F is a SPDT switch GaAs MMIC which features low loss, high isolation and low operating voltage, and ideally suitable for the T/R switch of digital wireless phone handsets.

This switch is operated in the wide frequency range from 50MHz to 3GHz at low operating voltage from +2.5V with very small MTP6 package.

■PACKAGE OUTLINE

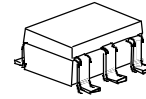

NJG1509F

■FEATURES

- Single and low positive control voltage +2.5V~+5.5V
- Low insertion loss 0.5dB typ. @f=2GHz, $P_{in}=22\text{dBm}$.
- Passing power 27dBm max. @f=2GHz $V_{CTL}=3.0\text{V}$
- High Isolation 25dB typ. @f=2GHz, $P_{in}=22\text{dBm}$
- Low control current 5uA typ. @f=0.05~2.5GHz, $P_{in}=22\text{dBm}$
- Package MTP6 (Mount Size: 2.8x2.9x1.2mm)

■PIN CONFIGURATION

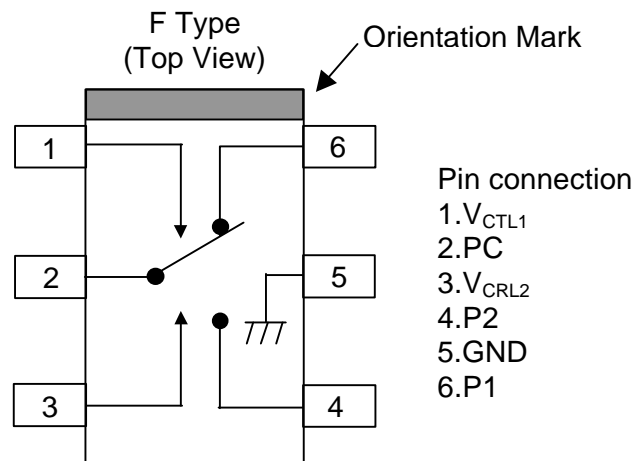

■TRUTH TABLE

“H”= V_{CTR} (H), “L”= V_{CTR} (L)

V_{CTL1}	H	L	L	H
V_{CTL2}	L	H	L	H
P1-PC	OFF	ON	Loss =15dB P_1 Return Loss =-3dB	Loss =16dB P_1 Return Loss =-2dB
P2-PC	ON	OFF	Loss =15dB P_2 Return Loss =-3dB	Loss =16dB P_2 Return Loss =-2dB

Note) The values of “Loss” and “Return Loss” are typical values.

NJG1509F

■ABSOLUTE MAXIMUM RATINGS

($T_a=25^{\circ}\text{C}$)

PARAMETER	SYMBOL	RATINGS	UNITS
Input Power	P_{in}	31	dBm
Control Voltage	V_{CTL}	6	V
Power Dissipation	P_D	300	mW
Operating Temp.	T_{opr}	-30~+85	$^{\circ}\text{C}$
Storage Temp.	T_{stg}	-40~+150	$^{\circ}\text{C}$

■ELECTRICAL CHARACTERISTICS

($V_{CTL(L)}=0\text{V}$, $V_{CTL(H)}=2.7\text{V}$, $Z_S=Z_O=50\Omega$, $T_a=25^{\circ}\text{C}$)

PARAMETER	SYMBOL	CONDITIONS	MIN	TYP	MAX	UNITS
Control voltage (L)	$V_{CTL(L)}$	$f=0.05\sim 2.5\text{GHz}$, $P_{in}=10\text{dBm}$	-0.2	0	0.2	V
Control voltage (H)	$V_{CTL(H)}$	$f=0.05\sim 2.5\text{GHz}$, $P_{in}=10\text{dBm}$	2.5	2.7	5.5	V
Control current	I_{CTL}	$f=0.05\sim 2.5\text{GHz}$, $P_{in}=10\text{dBm}$	-	5.0	8.0	μA
Insertion loss 1	LOSS1	$f=1\text{GHz}$, $P_{in}=22\text{dBm}$	-	0.4	0.7	dB
Insertion loss 2	LOSS2	$f=2\text{GHz}$, $P_{in}=22\text{dBm}$	-	0.5	0.8	dB
Isolation 1 (PC-P1, PC-P2, P1-P2)	ISL1	$f=1\text{GHz}$, $P_{in}=22\text{dBm}$	23	28	-	dB
Isolation 2 (PC-P1, PC-P2, P1-P2)	ISL2	$f=2\text{GHz}$, $P_{in}=22\text{dBm}$	20	25	-	dB
Pin at 1dB compression point 1	$P_{-1\text{dB}1}$	$f=2\text{GHz}$	26	28	-	dBm
Pin at 1dB compression point 2	$P_{-1\text{dB}2}$	$V_{CTL(H)}=3.0\text{V}$, $f=2\text{GHz}$	27	30	-	dBm
VSWR (PC, P1, P2)	VSWR	$f=0.05\sim 2.5\text{GHz}$, ON State	-	1.3	1.6	
Switching time	T_{SW}	$f=0.05\sim 2.5\text{GHz}$	-	15	-	ns

■ TYPICAL CHARACTERISTICS

(PC-P1) Insertion loss vs. Frequency
($V_{CTR}=0V/2.7V$, $P_{in}=22dBm$)

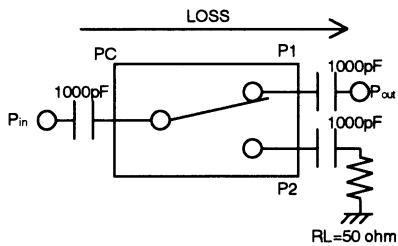
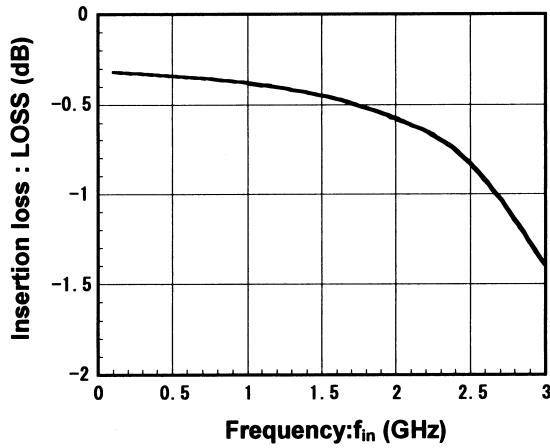

(PC-P2) Insertion loss vs. Frequency
($V_{CTR}=0V/2.7V$, $P_{in}=22dBm$)

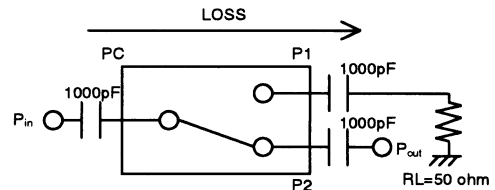
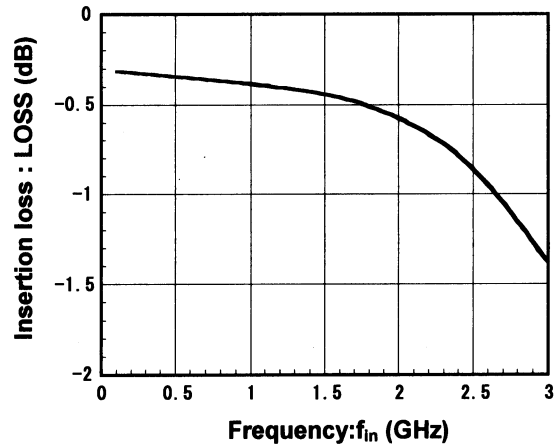

(PC-P1) Isolation vs. Frequency
($V_{CTR}=0V/2.7V$, $P_{in}=22dBm$)

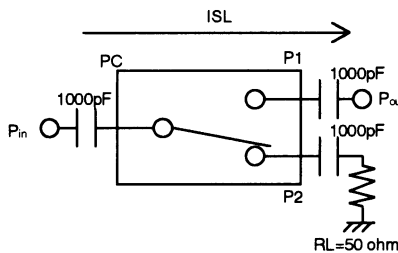
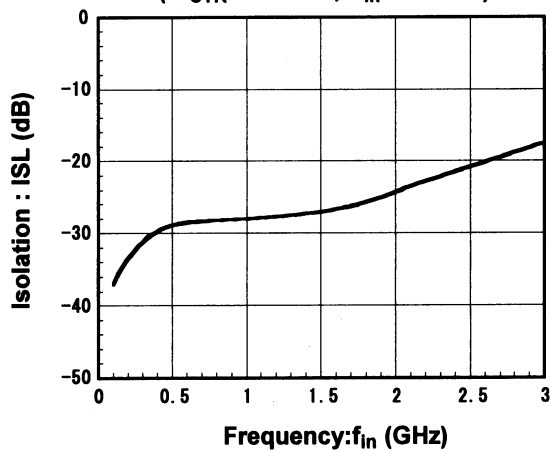

(PC-P2) Isolation vs. Frequency
($V_{CTR}=0V/2.7V$, $P_{in}=22dBm$)

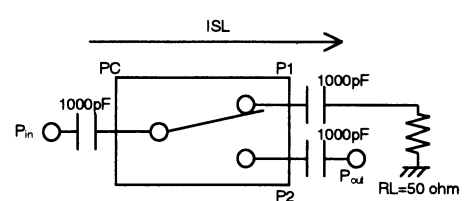
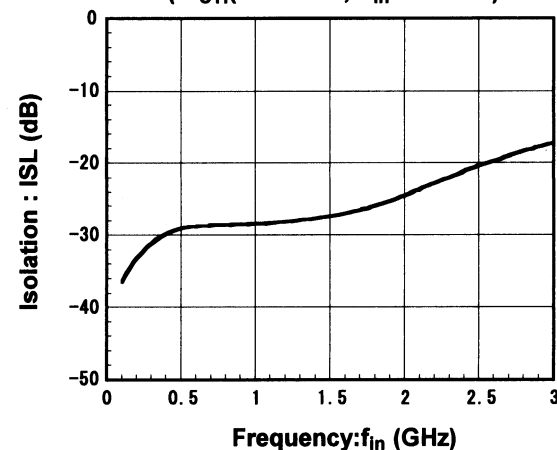

■ TYPICAL CHARACTERISTICS

P1-PC(ON)V.S.W.R vs. Frequency
($V_{CTR}=0V/2.7V$, $P_{in}=0dBm$)

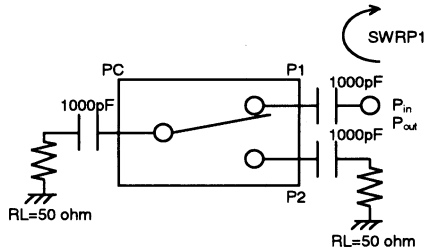
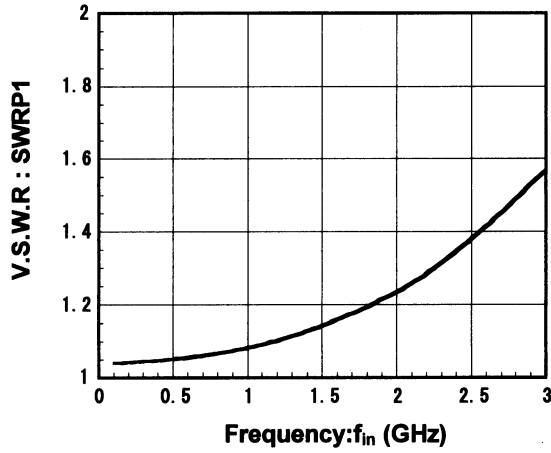

P2-PC(ON)V.S.W.R vs. Frequency
($V_{CTR}=0V/2.7V$, $P_{in}=0dBm$)

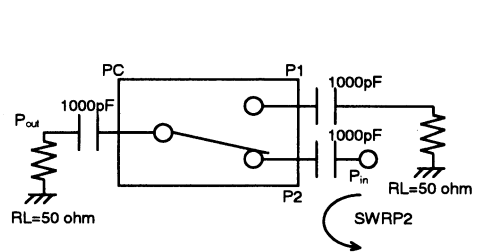
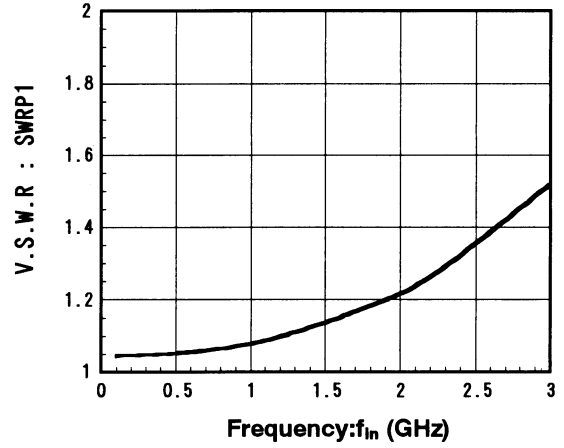

PC-P1(ON)V.S.W.R vs. Frequency
($V_{CTR}=0V/2.7V$, $P_{in}=0dBm$)

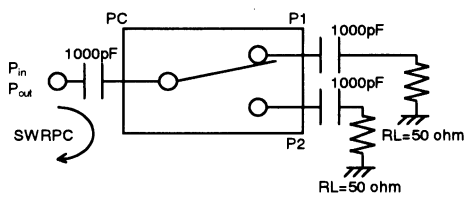
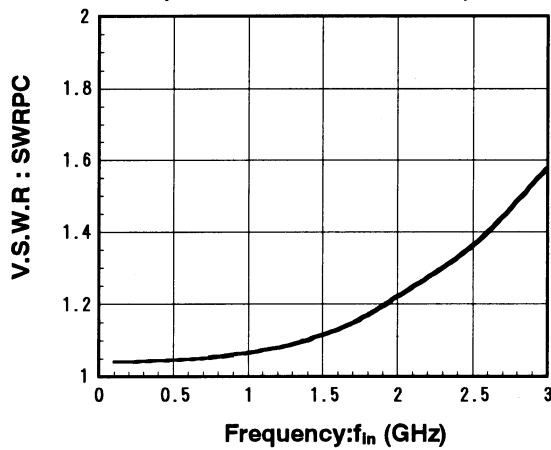

■ TYPICAL CHARACTERISTICS

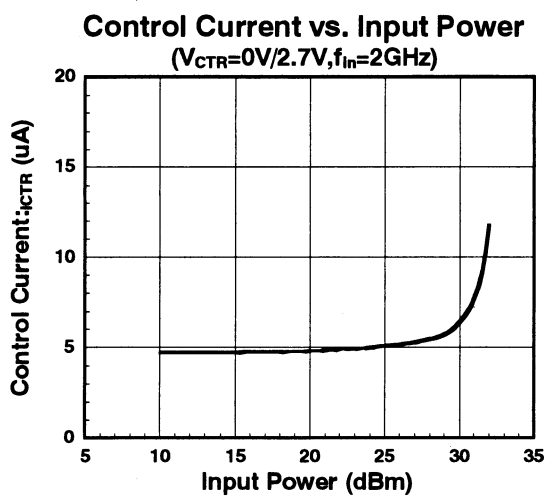
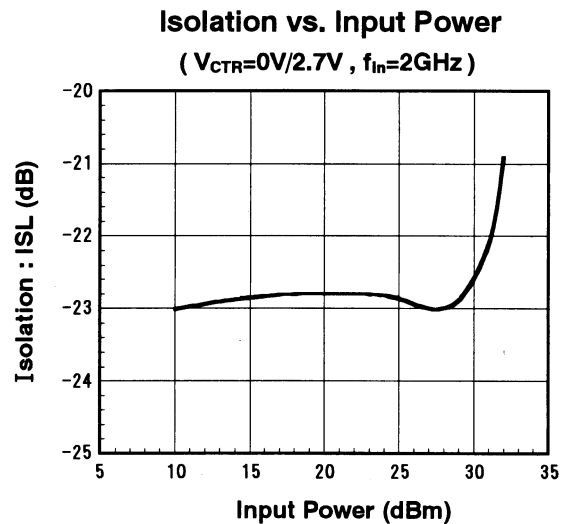
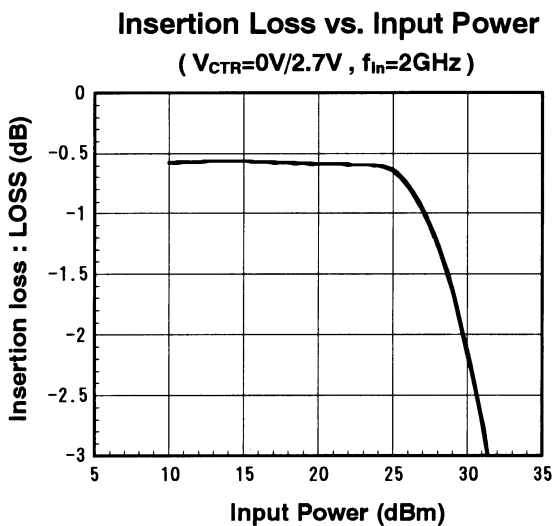
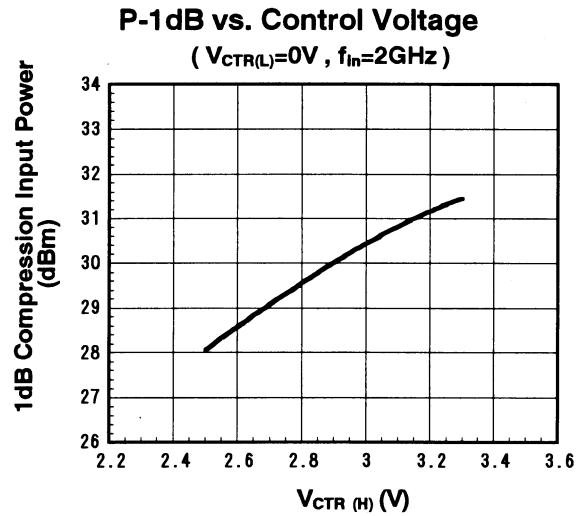
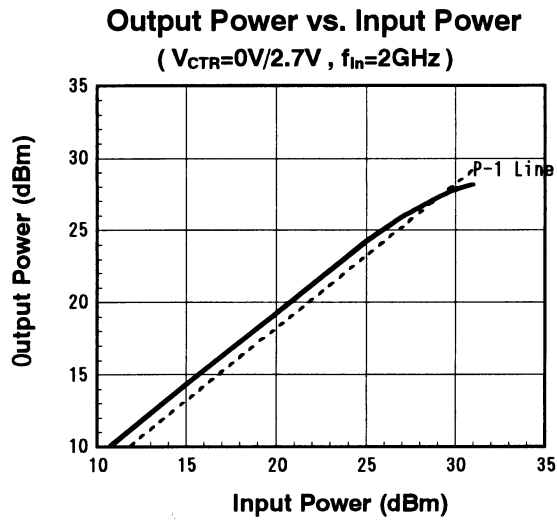

■ TYPICAL CHARACTERISTICS

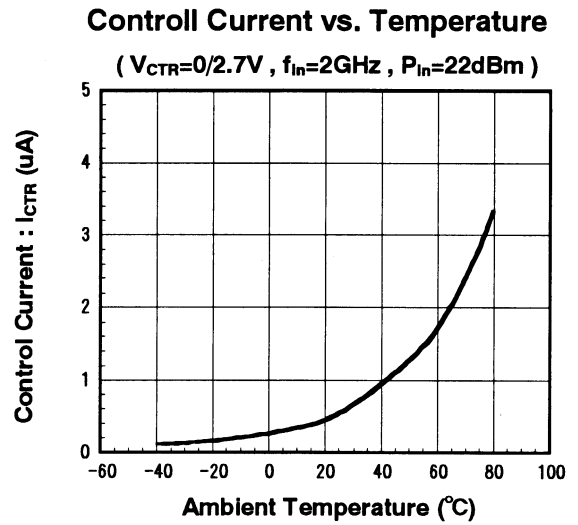
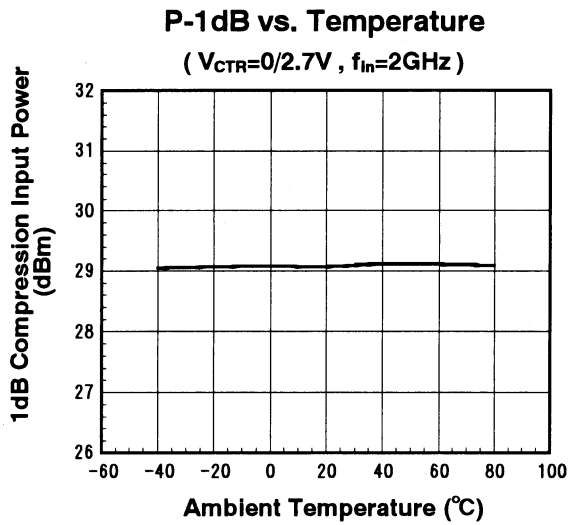
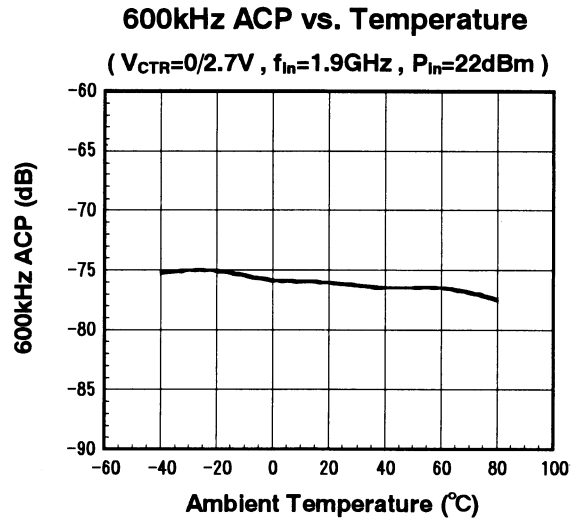
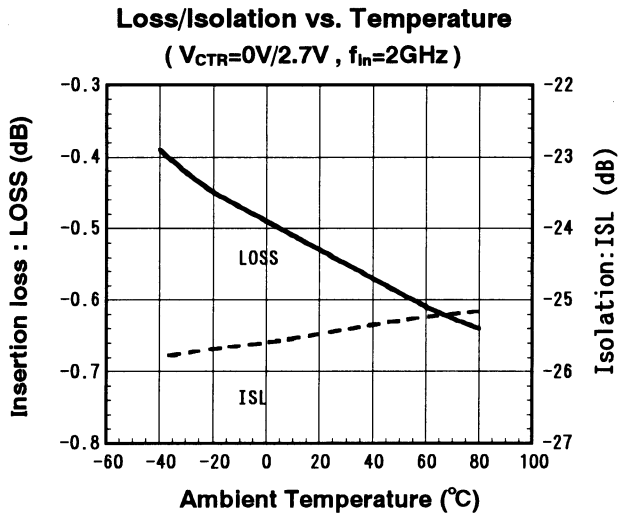

■ TYPICAL CHARACTERISTICS

600kHz ACP 特性 (Ta=25°C)

DQPSK Modulation Signal (without D.U.T)

f_{in}=1.9GHz P_{in}=22dBm

MODULATION : 384Kbps RNYQ α=0.5 1/4 π DQPSK

-ATTEN 20dB

RL 10.0dBm 10dB/

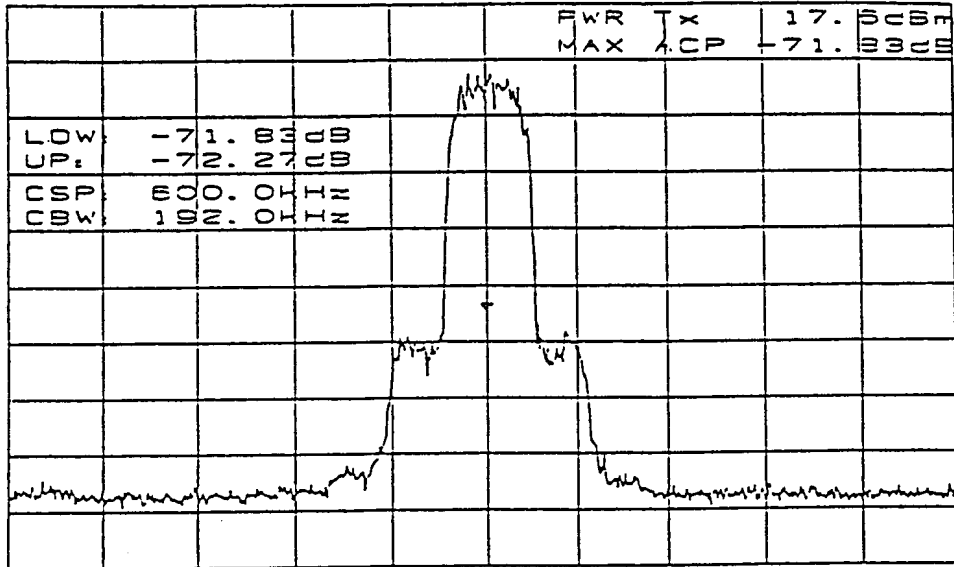

CENTER 1.900000GHz

SPAN 3.000MHz

-RBW 1.0kHz -VBW 10kHz

-SWP 10.2sec

Insertion PORT : PC → P1

f_{in}=1.9GHz P_{in}=22dBm V_{CTR}=0/2.7V

MODULATION : 384Kbps RNYQ α=0.5 1/4 π DQPSK

-ATTEN 20dB

RL 10.0dBm 10dB/

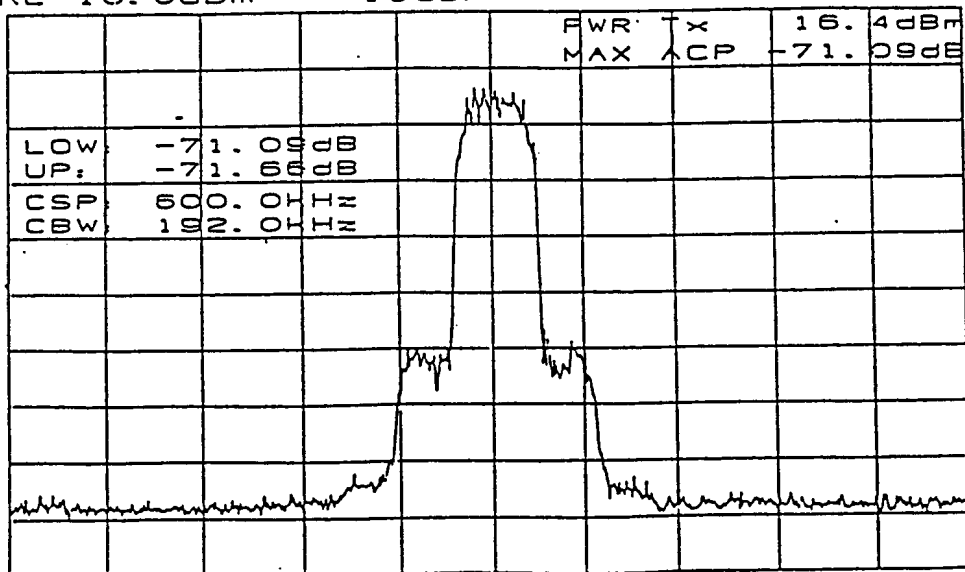

CENTER 1.900000GHz

SPAN 3.000MHz

-RBW 1.0kHz -VBW 10kHz

SWP 7.50sec

NJG1509F

■TYPICAL CHARACTERISTICS

900kHz ACP (Ta=25°C)

Insertion PORT: PC → P1

f_{in}=1.9GHz P_{in}=22dBm V_{CTR}=0/2.7V

MODULATION: 384Kbps RNYQ α=0.5 1/4 π DQPSK

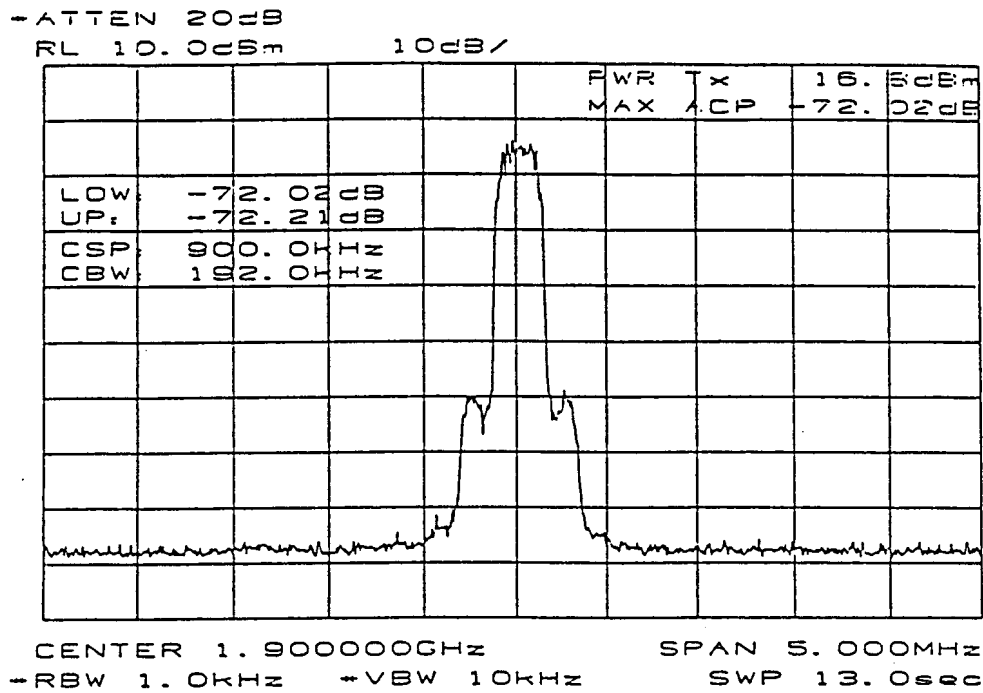

Harmonics (Ta=25°C)

f_{in}=1.9GHz P_{in}=22dBm V_{CTR(H)}=2.7V

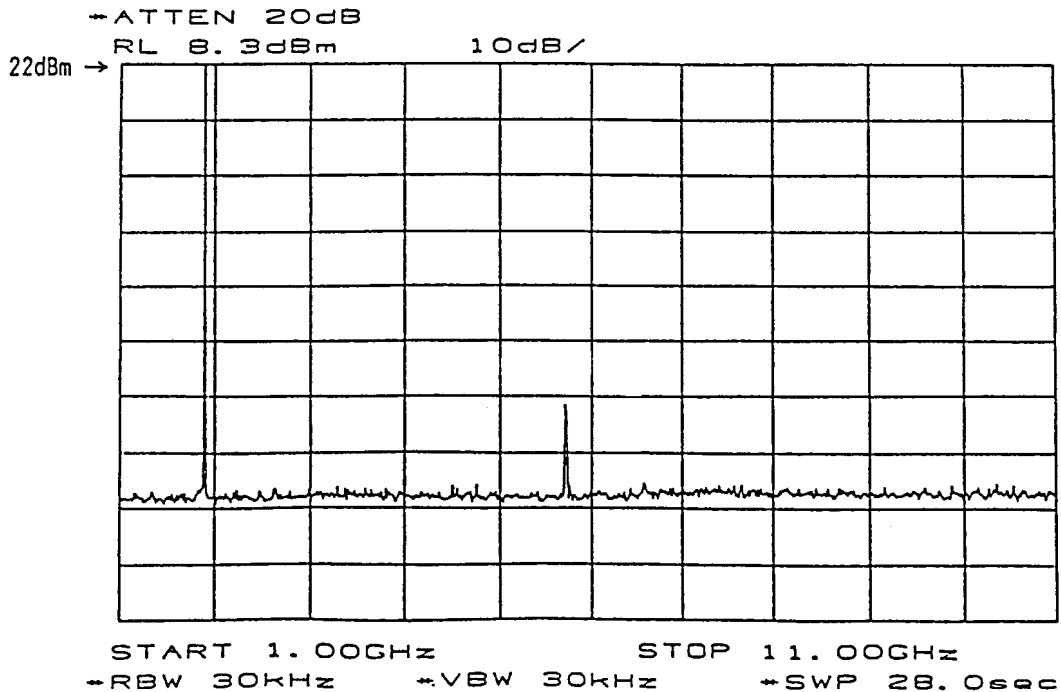

■ TYPICAL CHARACTERISTICS

P1 PORT IMPEDANCE (OFF STATE)

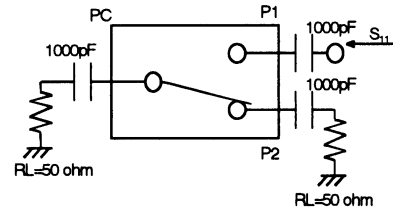
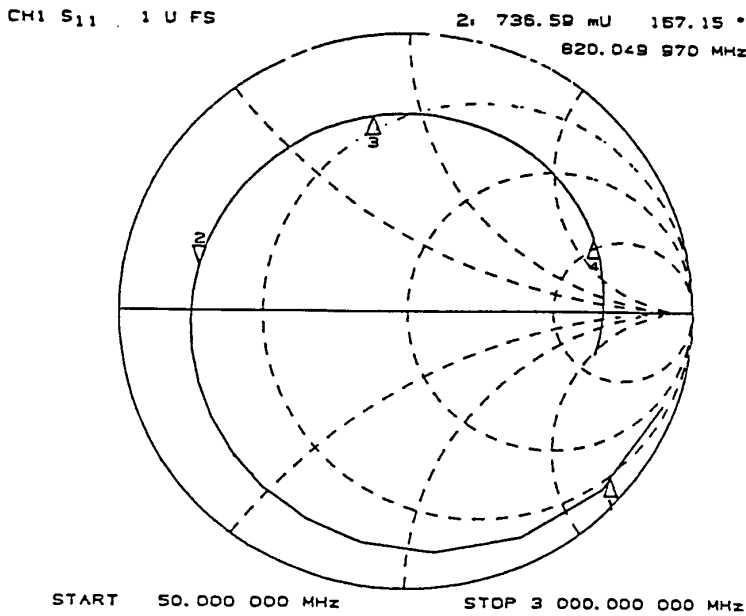

MARKER	f (MHz)	Mag.	Ang. (∠°)
1	50	0.954	-15.4
2	800	0.755	-172.5
3	1500	0.716	113.6
4	2000	0.710	72.3
5	3000	0.693	1.4

P2 PORT IMPEDANCE (OFF STATE)

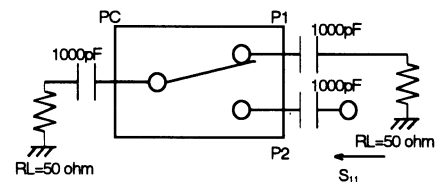
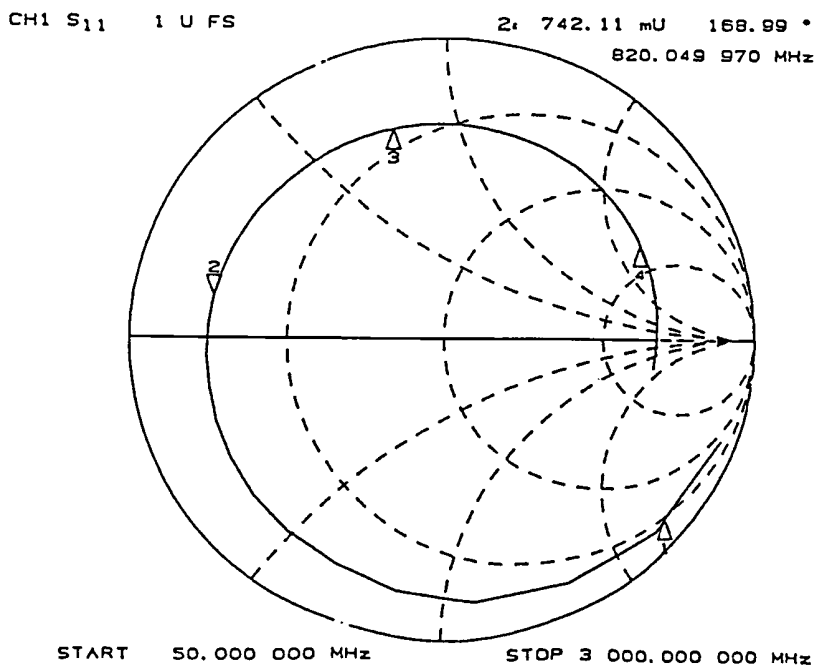

MARKER	f (MHz)	Mag.	Ang. (∠°)
1	50	0.952	-15.5
2	800	0.767	-173.6
3	1500	0.731	111.1
4	2000	0.723	68.7

■ TYPICAL CHARACTERISTICS

Scattering Parameters: S11 (OFF STATE)

($V_{CTR}=0/2.7V$, 50Ω System)

f(MHz)	P1 PORT		P2 PORT	
	Mag.	Ang.(\angle°)	Mag.	Ang.(\angle°)
50	0.954	-15.4	0.952	-15.5
100	0.945	-30.9	0.945	-31.0
200	0.909	-59.0	0.910	-59.2
300	0.872	-84.5	0.879	-84.9
400	0.837	-106.8	0.844	-107.2
500	0.809	-126.3	0.817	-127.1
600	0.783	-143.4	0.793	-144.3
700	0.766	-158.8	0.778	-159.8
800	0.755	-172.5	0.767	-173.6
900	0.743	174.9	0.758	173.4
1000	0.734	163.1	0.749	161.7
1100	0.722	151.5	0.736	150.0
1200	0.724	141.8	0.737	139.8
1300	0.722	132.0	0.733	129.9
1400	0.719	122.6	0.734	120.4
1500	0.716	113.6	0.731	111.1
1600	0.716	104.9	0.730	102.2
1700	0.714	96.7	0.726	93.7
1800	0.713	88.2	0.725	85.2
1900	0.712	80.2	0.723	76.9
2000	0.710	72.3	0.723	68.7
2100	0.710	65.0	0.723	61.2
2200	0.710	57.4	0.721	53.2
2300	0.708	49.9	0.716	45.5
2400	0.707	42.6	0.717	38.2
2500	0.705	35.4	0.714	30.7
2600	0.703	28.6	0.712	23.6
2700	0.703	21.9	0.711	16.7
2800	0.700	14.8	0.709	9.3
2900	0.696	8.0	0.707	2.3
3000	0.693	1.4	0.701	-4.8

APPLICATION CIRCUIT 1: Single control signal operation by using C-MOS inverter.

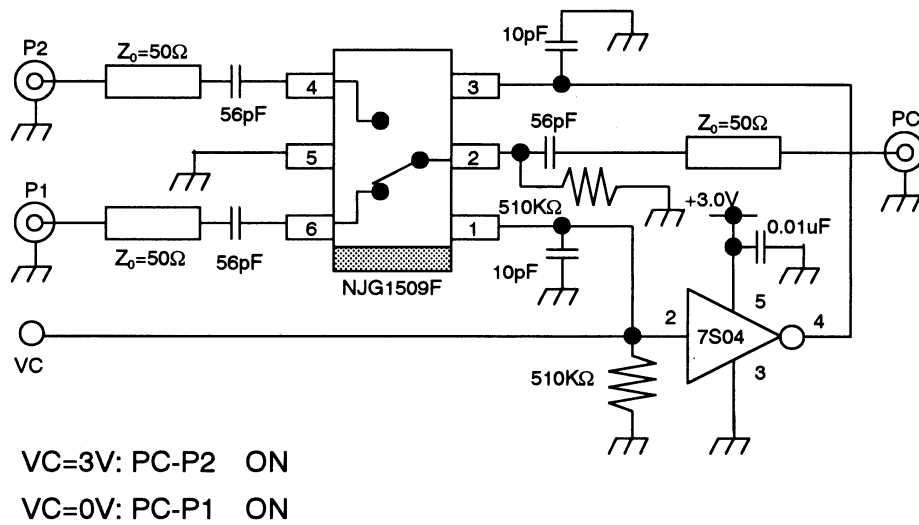

- [1]Please connect bypass capacitors to the supply terminal of the C-MOS inverter.
- [2]In order to stabilize input impedance of inverter, please pull down using 510KΩ resistor from the input terminal of the C-MOS inverter to the ground plane.

APPLICATION CIRCUIT 2: Single control signal operation by using a transistor.

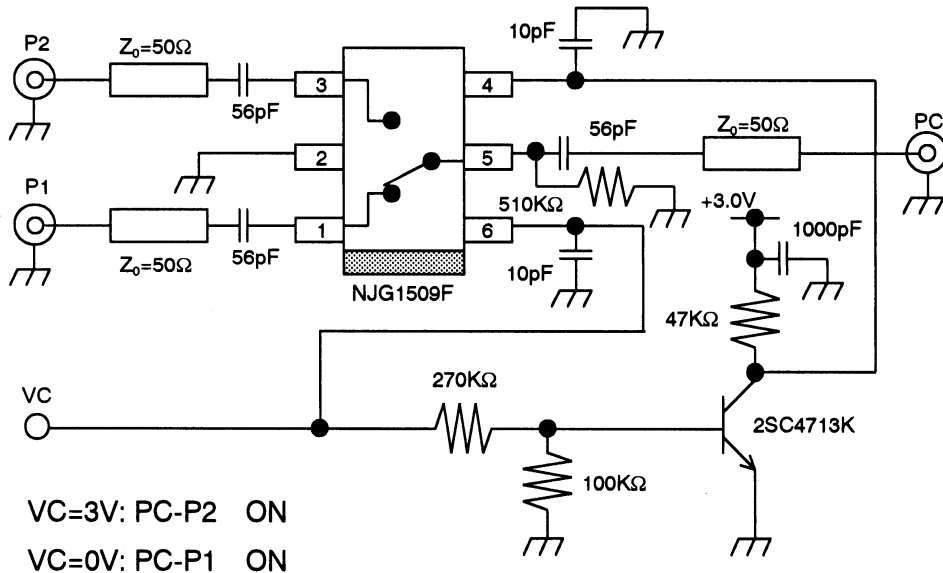

NJG1509F

TEST CIRCUIT

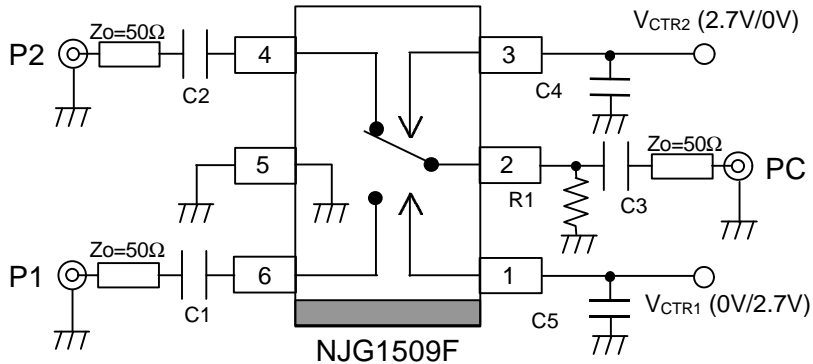

RECOMMENDED PCB DESIGN

(TOP VIEW)

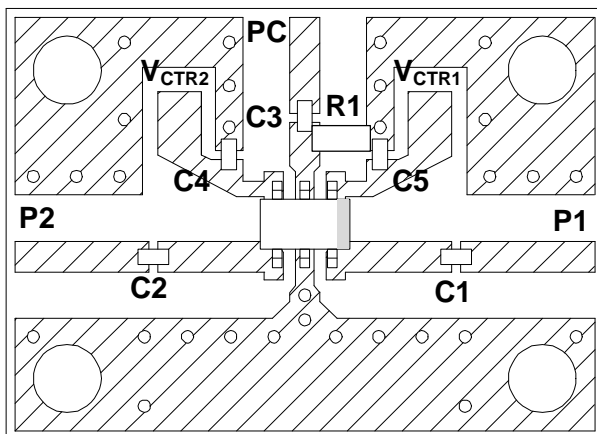

PCB SIZE=19.4x14.0mm
 PCB: FR-4, t=0.5mm
 CAPACITOR: size 1005
 STRIP LINE WIDTH=1mm
 C1~C3: 56pF
 C4, C5: 10pF
 R1: 510KΩ

Precaution

- [1] External capacitors should be connected to the input and output RF terminals (P1, P2, PC) to block the DC current. The above example is a circuit at 900MHz. Please select the capacitors value suitable for actual frequency from 10pF to 1000pF.
- [2] Decoupling capacitors should be connected to the control terminals (V_{CTR1} , V_{CTR2}) as close as possible. The values of these capacitors should be selected from 5pF to 100pF range. Please consider that these values are very effective to switching time (Larger capacitor gives longer switching time).
- [3] In order to keep good isolation characteristics, the ground terminal (5pin) should be connected to the ground pattern with wide width as close as possible, and though-hole in the ground plane should also be placed as close as possible.

■PACKAGE OUTLINE (MTP6)

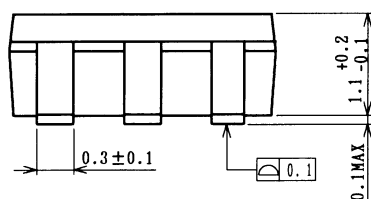
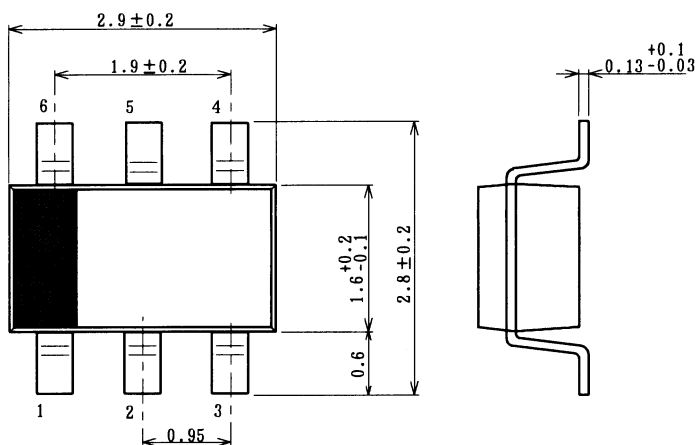

Lead material	: Copper
Lead surface finish	: Solder plating
Molding material	: Epoxy resin
UNIT	: mm
Weight	: 14mg

Cautions on using this product

- This product contains Gallium-Arsenide (GaAs) which is a harmful material.
- Do NOT eat or put into mouth.
 - Do NOT dispose in fire or break up this product.
 - Do NOT chemically make gas or powder with this product.
 - To waste this product, please obey the relating law of your country.

[CAUTION]

The specifications on this databook are only given for information, without any guarantee as regards either mistakes or omissions. The application circuits in this databook are described only to show representative usages of the product and not intended for the guarantee or permission of any right including the industrial rights.

This product may be damaged with electric static discharge (ESD) or spike voltage. Please handle with care to avoid these damages.

SUNSTAR 商斯达实业集团是集研发、生产、工程、销售、代理经销、技术咨询、信息服务等为一体的高科技企业，是专业高科技电子产品生产厂家，是具有 10 多年历史的专业电子元器件供应商，是中国最早和最大的仓储式连锁规模经营大型综合电子零部件代理分销商之一，是一家专业代理和分销世界各大品牌 IC 芯片和电子元器件的连锁经营综合性国际公司，专业经营进口、国产名厂名牌电子元件，型号、种类齐全。在香港、北京、深圳、上海、西安、成都等全国主要电子市场设有直属分公司和产品展示展销窗口门市部专卖店及代理分销商，已在全国范围内建成强大统一的供货和代理分销网络。我们专业代理经销、开发生产电子元器件、集成电路、传感器、微波光电元器件、工控机/DOC/DOM 电子盘、专用电路、单片机开发、MCU/DSP/ARM/FPGA 软件硬件、二极管、三极管、模块等，是您可靠的一站式现货配套供应商、方案提供商、部件功能模块开发配套商。商斯达实业公司拥有庞大的资料库，有数位毕业于著名高校——有中国电子工业摇篮之称的西安电子科技大学（西军电）并长期从事国防尖端科技研究的高级工程师为您精挑细选、量身订做各种高科技电子元器件，并解决各种技术问题。

微波光电部专业代理经销高频、微波、光纤、光电元器件、组件、部件、模块、整机；电磁兼容元器件、材料、设备；微波 CAD、EDA 软件、开发测试仿真工具；微波、光纤仪器仪表。欢迎国外高科技微波、光纤厂商将优秀产品介绍到中国、共同开拓市场。长期大量现货专业批发高频、微波、卫星、光纤、电视、CATV 器件：晶振、VCO、连接器、PIN 开关、变容二极管、开关二极管、低噪晶体管、功率电阻及电容、放大器、功率管、MMIC、混频器、耦合器、功分器、振荡器、合成器、衰减器、滤波器、隔离器、环行器、移相器、调制解调器；光电子元件和组件：红外发射管、红外接收管、光电开关、光敏管、发光二极管和发光二极管组件、半导体激光二极管和激光器组件、光电探测器和光接收组件、光发射接收模块、光纤激光器和光放大器、光调制器、光开关、DWDM 用光发射和接收器件、用户接入系统光收发器件与模块、光纤连接器、光纤跳线/尾纤、光衰减器、光纤适配器、光隔离器、光耦合器、光环行器、光复用器/转换器；无线收发芯片和模组、蓝牙芯片和模组。

更多产品请看本公司产品专用销售网站：

商斯达中国传感器科技信息网：<http://www.sensor-ic.com/>

商斯达工控安防网：<http://www.pc-ps.net/>

商斯达电子元器件网：<http://www.sunstare.com/>

商斯达微波光电产品网：[HTTP://www.rfoe.net/](http://www.rfoe.net/)

商斯达消费电子产品网：<http://www.icasic.com/>

商斯达实业科技产品网：<http://www.sunstars.cn/> 微波元器件销售热线：

地址：深圳市福田区福华路福庆街鸿图大厦 1602 室

电话：0755-82884100 83397033 83396822 83398585

传真：0755-83376182 (0) 13823648918 MSN: SUNS8888@hotmail.com

邮编：518033 E-mail:szss20@163.com QQ: 195847376

深圳赛格展销部：深圳华强北路赛格电子市场 2583 号 电话：0755-83665529 25059422

技术支持：0755-83394033 13501568376

欢迎索取免费详细资料、设计指南和光盘；产品凡多，未能尽录，欢迎来电查询。

北京分公司：北京海淀区知春路 132 号中发电子大厦 3097 号

TEL: 010-81159046 82615020 13501189838 FAX: 010-62543996

上海分公司：上海市北京东路 668 号上海赛格电子市场 D125 号

TEL: 021-28311762 56703037 13701955389 FAX: 021-56703037

西安分公司：西安高新开发区 20 所(中国电子科技集团导航技术研究所)

西安劳动南路 88 号电子商城二楼 D23 号

TEL: 029-81022619 13072977981 FAX:029-88789382