

GENERAL PURPOSE PHOTO REFLECTOR

■ GENERAL DESCRIPTION

The NJL5198K/5199K are super miniature and super thin general purpose photo reflectors designed for car-audio applications. Durability under temperature cycle has been greatly improved same as NJL5175K/5177K (compared to our conventional products, the durability has been doubled.), and attain high cost performance.

■ FEATURES

- Super miniature, super thin type
- Built-in visible light cut-off filter.
- High output, high S/N ratio, high durability.

■ APPLICATIONS

- The end detector for video or audio tape etc.
- Rotation detection and control to be applied for car-audio turntables.

■ ABSOLUTE MAXIMUM RATINGS (Ta=25 °C)

PARAMETER	SYMBOL	RATINGS	UNIT
Emitter			
Forward Current (Continuous)	I_F	30	mA
Reverse Voltage (Continuous)	V_R	6	V
Power Dissipation	P_D	45	mW
Detector			
Collector-Emitter Voltage	V_{CEO}	16	V
Emitter-Collector Voltage	V_{ECO}	6	V
Collector Current	I_C	10	mA
Collector Power Dissipation	P_C	25	mW
Coupled			
Total Power Dissipation	P_{tot}	60	mW
Operating Temperature	T_{opr}	-30~+85	°C
Storage Temperature	T_{stg}	-40~+85	°C
Soldering Temperature	T_{sol}	260(10sec. 1.5mm from body)	°C

■ ELECTRO-OPTICAL CHARACTERISTICS (Ta=25 °C)

PARAMETER	SYMBOL	TEST CONDITION	MIN.	TYP.	MAX.	UNIT
Emitter						
Forward Voltage	V_F	$I_F=4mA$	—	—	1.4	V
Reverse Current	I_R	$V_R=6V$	—	—	10	μA
Capacitance	C_t	$V_R=0V, f=1MHz$	—	25	—	pF
Detector						
Dark Current	I_{CEO}	$V_{CE}=10V$	—	—	0.2	μA
Collector-Emitter Voltage	V_{CEO}	$I_C=100\mu A$	16	—	—	V
Coupled						
Output Current	I_O	$I_F=4mA, V_{CE}=2V, d=0.7mm$	50	—	150	μA
Operating Dark Current	$I_{CEO D}$	$I_F=4mA, V_{CE}=2V$	—	—	0.2	μA
Rise Time	t_r	$I_O=100\mu A, V_{CE}=2V, RL=1K\Omega, d=0.7mm$	—	30	—	μS
Fall Time	t_f	$I_O=100\mu A, V_{CE}=2V, RL=1K\Omega, d=0.7mm$	—	30	—	μS

NJL5198K/99K

■ OUTLINE (typ.) Unit: mm

2

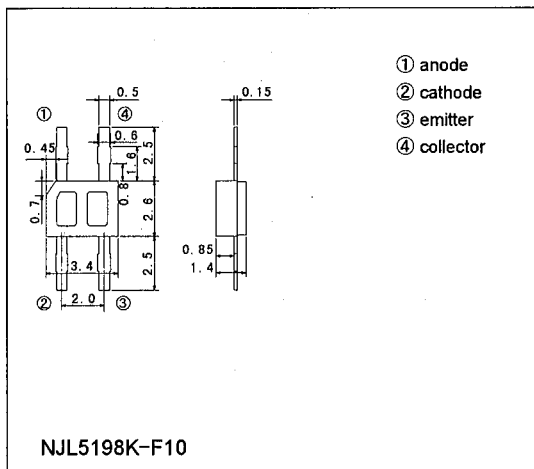
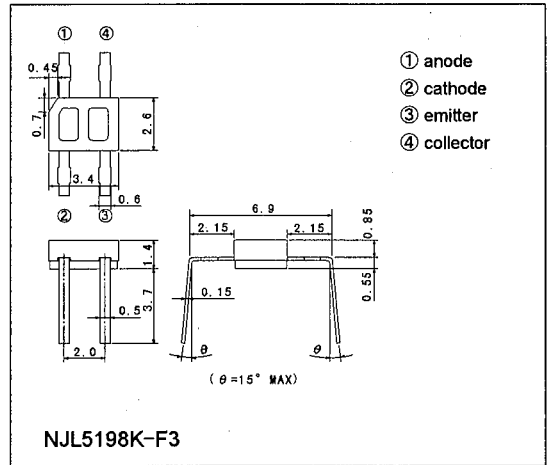
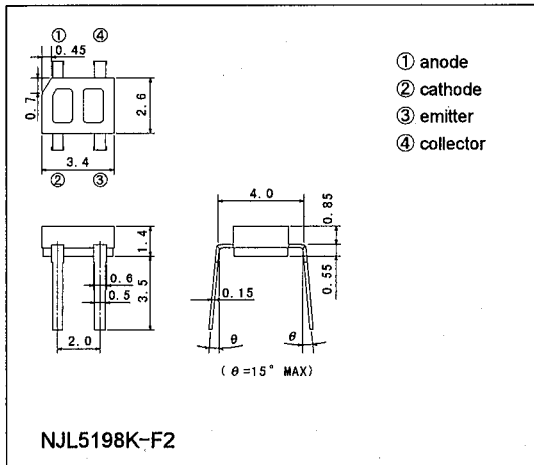
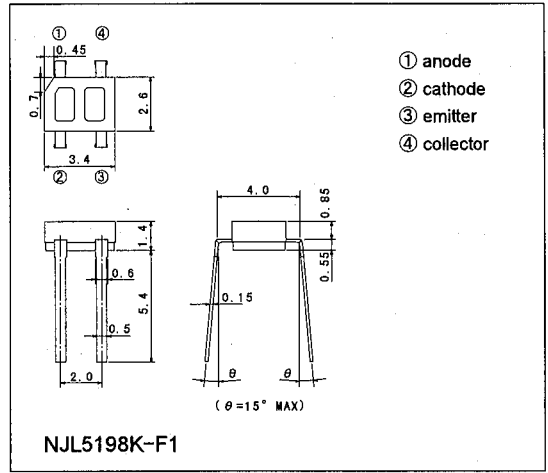
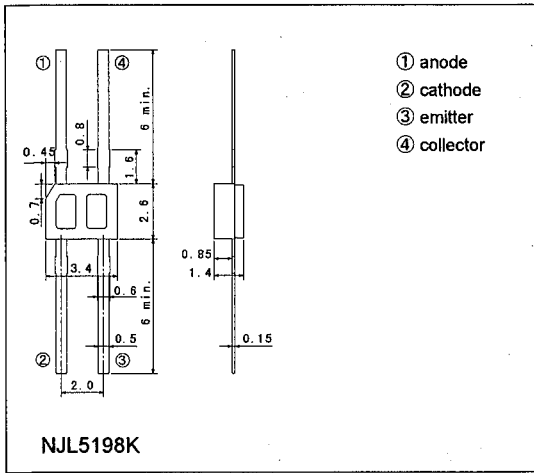

■ OUTLINE (typ.) Unit: mm

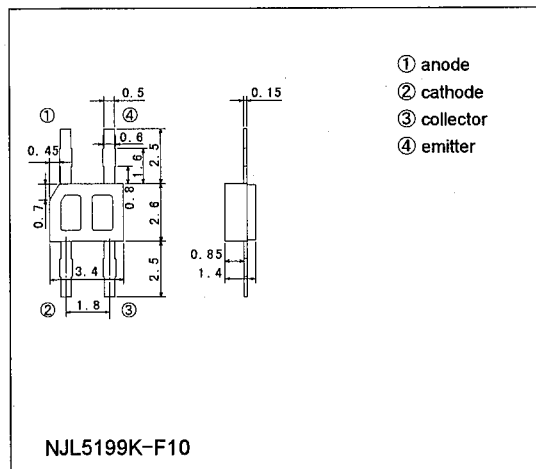
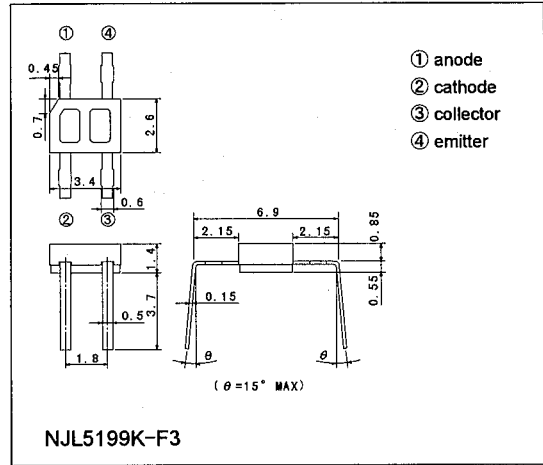
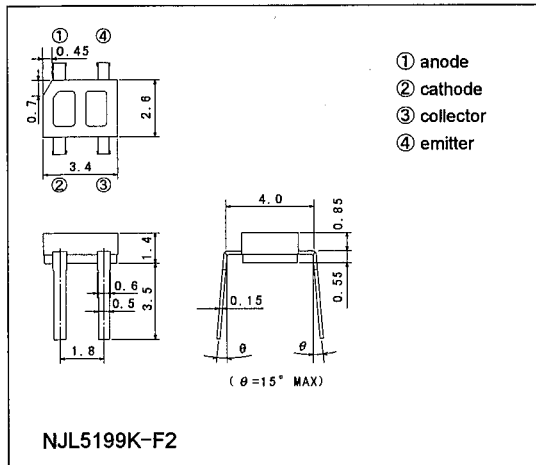
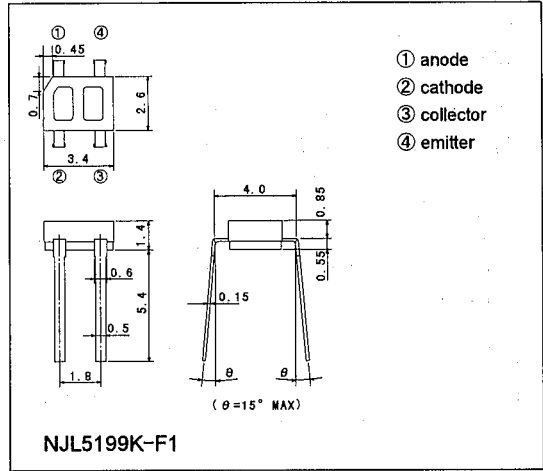
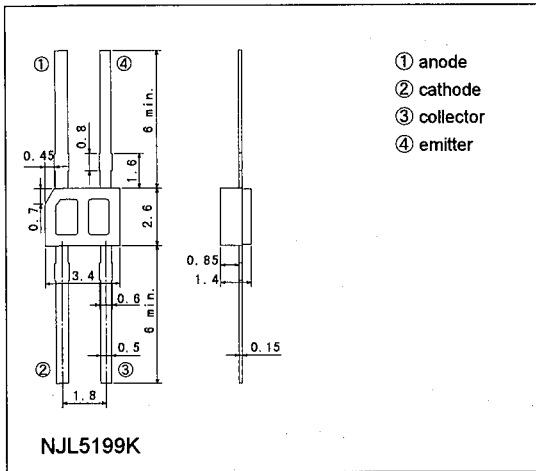

2

MEASURING SPECIFICATION FOR OUTPUT CURRENT

The output current can be measured when reflected at the aluminum

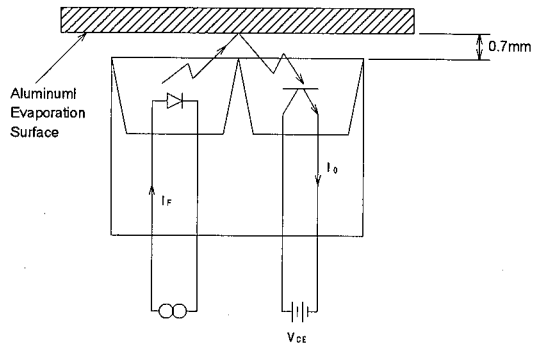

MEASURING CIRCUIT FOR OPERATING DARK CURRENT

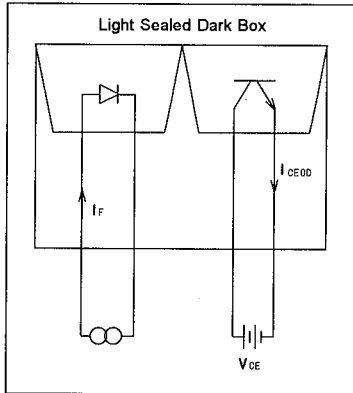

MEASURING SPECIFICATION FOR EDGE RESPONSE

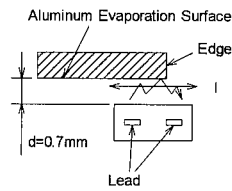

MEASURING CIRCUIT FOR RESPONSE TIME

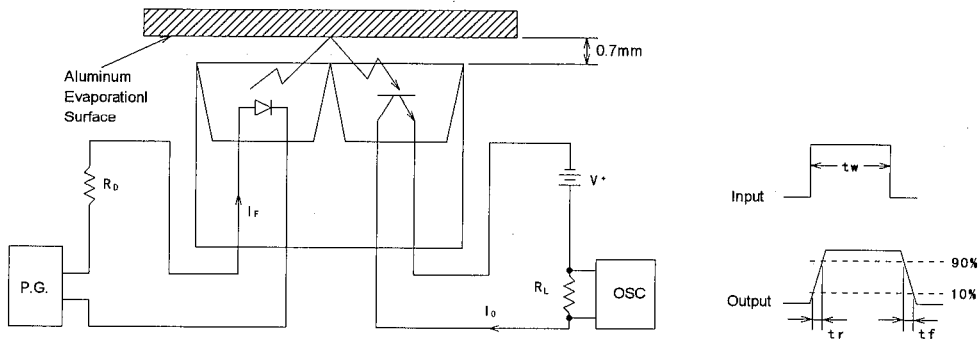

MAXIMUM RATING CURVES

Power Dissipation vs. Temperature

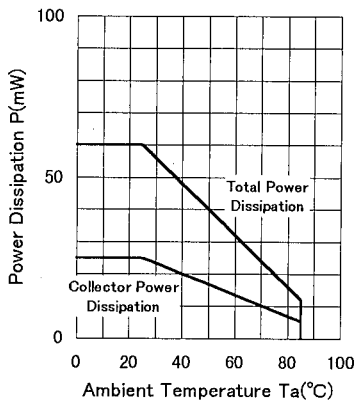

Forward Current vs. Temperature

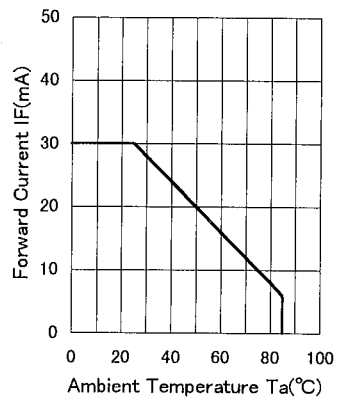

■ TYPICAL CHARACTERISTICS

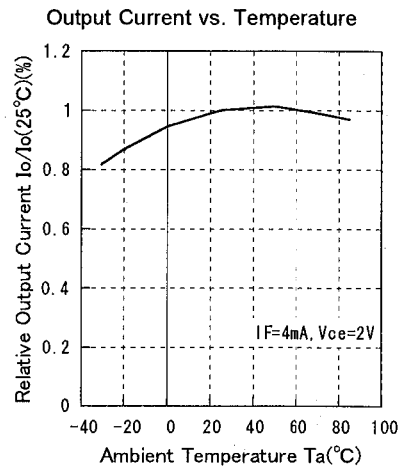
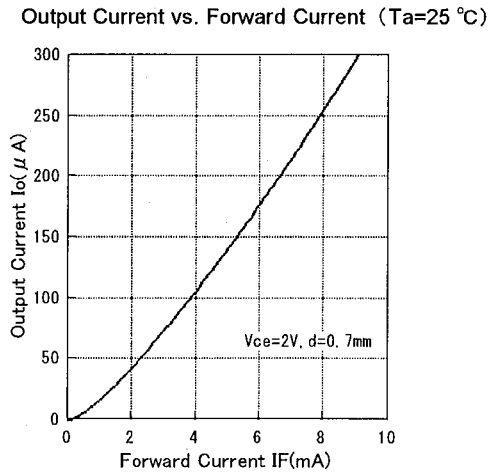
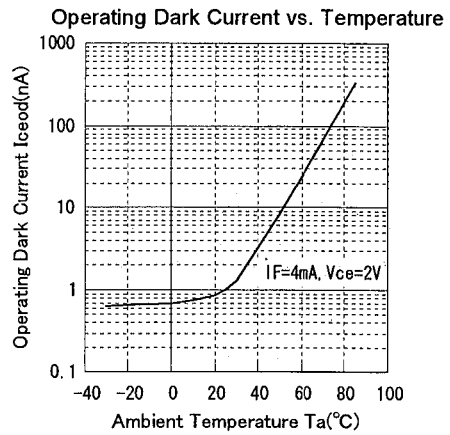
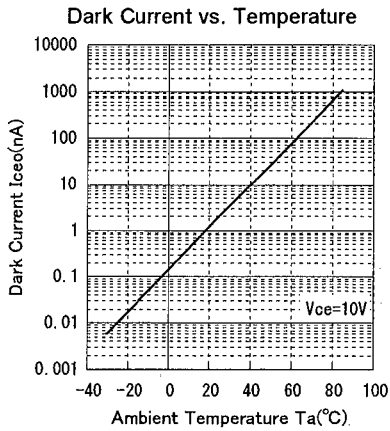
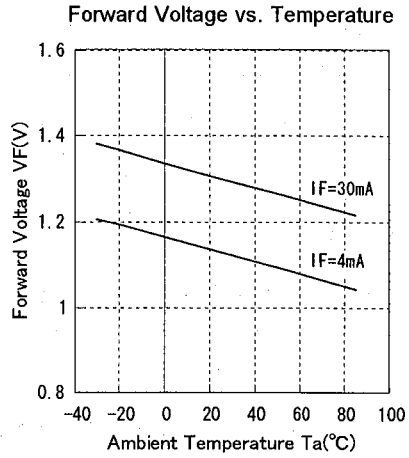
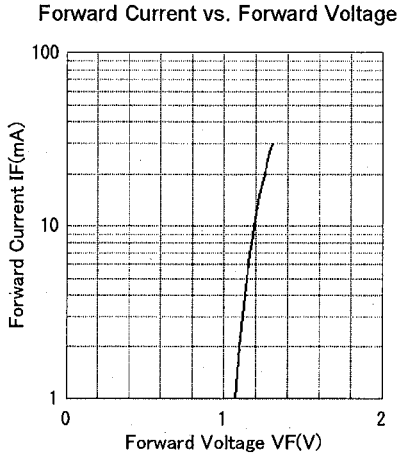

2

2

Output Characteristics (Ta=25 °C)

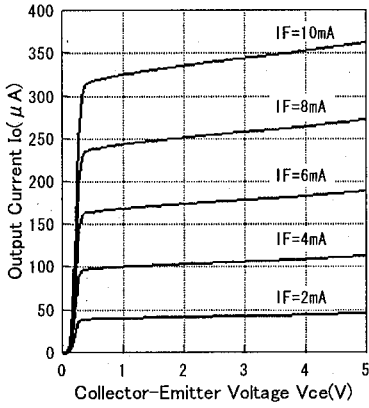

Vce Saturation (Ta=25 °C)

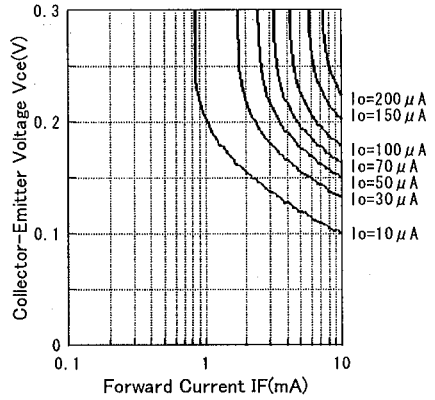

Output Current vs. Distance (Ta=25 °C)

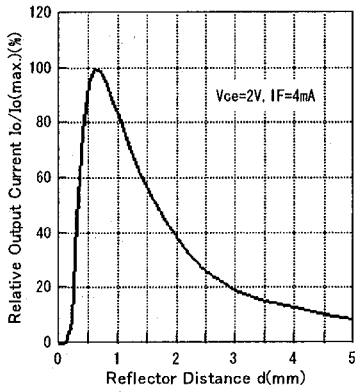

Output Current vs. Edge Distance (Ta=25 °C)

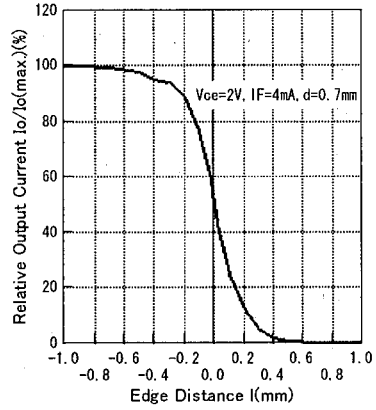

Spectral Response (Ta=25 °C)

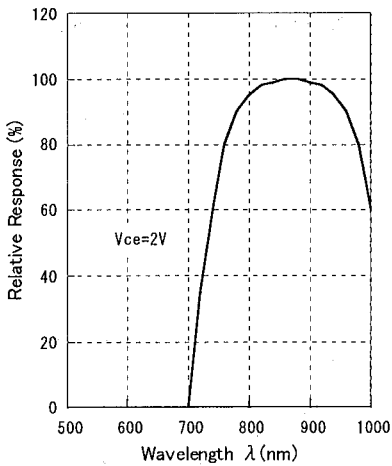

Switching Time vs. Load Resistance (Ta=25 °C)

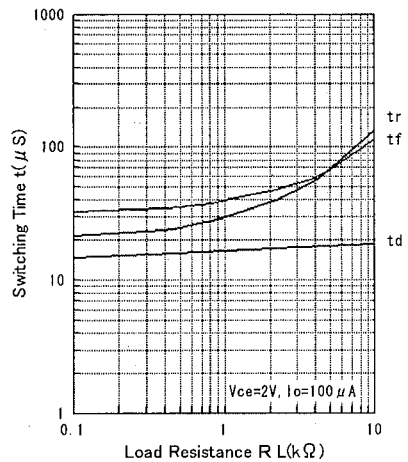

PRECAUTION FOR HANDLING

1. Soldering

1) Avoid the reflow method and solder to touch the body of the device during wave soldering. This is to prevent changes in optical characteristics of the device.

2) Recommended in Soldering

Temperature	Time Lead	Soldering Position
260 °C maximum	less than 10 seconds	At least 1.5mm from body

3) Soldering is recommended to be done in as short period of the time as possible by controlling the temperature of the soldering iron or by the iron of less than 15 watts.

4) The resin gets softened right after soldered, so, the following care has to be taken.

- Not to contact the lens surface to anything
- Not to dip the device into water or any solvents

5) It is recommended not to solder when the leads or between the lead get pulled, depressed or twisted.

6) In the case of using rosin flux, be careful to avoid contact with the lens surface. If the lens is covered with the flux, the specified characteristics cannot be achieved.



2. Post Solder Cleaning

1) Organic solvents for flux removal like trichloroethylene, acetone, thinner etc, might attach the lens surface. It is preferable to use less reactive solvents, Methyl Alcohol, Isopropyle Alcohol.

2) Cleaning Operation

Cleaning Solvent Temperature	: 35 °C maximum
Dipping Time	: 3 minute maximum

3. Attention in handling

1) Treat not to touch the lens surface.

2) Avoid dust and any other foreign materials(flux, paints, bonding material, etc) on the lens surface.

3) Never to apply reverse voltage (V_{EC}) of more than 6V on the photo transistor when measuring the characteristics or adjusting the system. If applied, it causes to lower the sensitivity.

4) When mounting, special care has to be taken on the mounting position and tilting of the device because it is very important to place the device to the optimum position to the object.

4. Storage

The leads are silver plated and they are discolored if the device is left open to the air for long after taken out of the envelop. It causes deterioration of soldering characteristics. Mount the device as short as possible after opening the envelope.

MEMO

[CAUTION]

The specifications on this databook are only given for information, without any guarantee as regards either mistakes or omissions. The application circuits in this databook are described only to show representative usages of the product and not intended for the guarantee or permission of any right including the industrial rights.