

DATA SHEET

BLV98CE UHF power transistor

Product specification

March 1993

UHF power transistor

BLV98CE

FEATURES

- Internal input matching to achieve high power gain
- Implanted ballasting resistors an for optimum temperature profile
- Gold metallization ensures excellent reliability

DESCRIPTION

NPN silicon planar epitaxial transistor in an SOT-171 envelope, intended for common emitter, class-AB operation in radio transmitters for the 960 MHz communications band. The transistor has a 6-lead flange envelope, with a ceramic cap. All leads are isolated from the flange.

QUICK REFERENCE DATA

RF performance up to $T_h = 25\text{ }^\circ\text{C}$ in a common emitter class-AB circuit.

MODE OF OPERATION	f (MHz)	V_{CE} (V)	P_L (W)	G_P (dB)	η_c (%)
c.w. class-AB	960	24	15	> 7.5	> 50

PINNING - SOT171A

PIN	SYMBOL	DESCRIPTION
1	e	emitter
2	e	emitter
3	b	base
4	c	collector
5	e	emitter
6	e	emitter

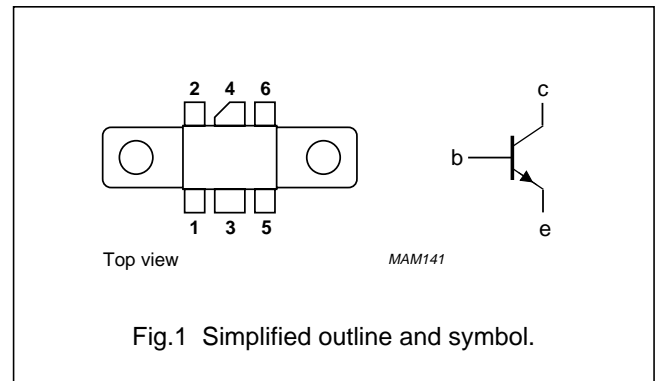

WARNING

Product and environmental safety - toxic materials

This product contains beryllium oxide. The product is entirely safe provided that the BeO disc is not damaged. All persons who handle, use or dispose of this product should be aware of its nature and of the necessary safety precautions. After use, dispose of as chemical or special waste according to the regulations applying at the location of the user. It must never be thrown out with the general or domestic waste.

UHF power transistor

BLV98CE

LIMITING VALUES

Limiting values in accordance with the Absolute Maximum System (IEC 134)

SYMBOL	PARAMETER	CONDITIONS	MIN.	MAX.	UNIT
V_{CBO}	collector base voltage	open emitter	–	50	V
V_{CEO}	collector emitter voltage	open base	–	27	V
V_{EBO}	emitter base voltage	open collector	–	3.5	V
I_C	collector current	DC or average	–	1.5	A
I_{CM}	collector current	peak value $f > 1$ MHz	–	4.5	A
P_{tot}	total power dissipation	$f > 1$ MHz $T_{mb} = 25$ °C	–	40	W
T_{stg}	storage temperature		–65	150	°C
T_j	operating junction temperature		–	200	°C

THERMAL RESISTANCE

SYMBOL	PARAMETER	CONDITIONS	TYP.	MAX.	UNIT
R_{thj-mb}	from junction to mounting base (RF)		–	4.4	K/W
$R_{th mb-h}$	from mounting base to heatsink		–	0.4	K/W

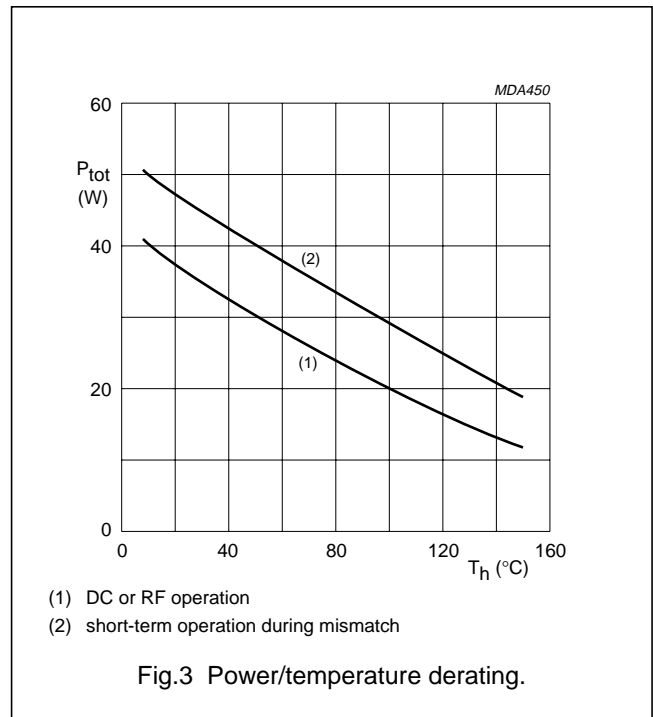
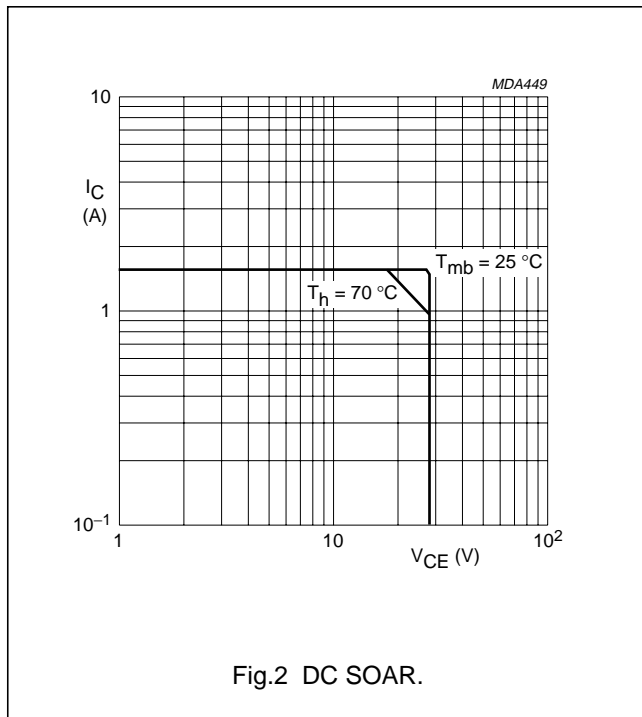

UHF power transistor

BLV98CE

CHARACTERISTICS

at $T_j = 25\text{ }^\circ\text{C}$ unless otherwise stated.

SYMBOL	PARAMETER	CONDITIONS	MIN.	TYP.	MAX.	UNIT
$V_{(BR)CBO}$	collector-base breakdown voltage	open emitter $I_C = 25\text{ mA}$	50	–	–	V
$V_{(BR)CEO}$	collector-emitter breakdown voltage	open base $I_C = 50\text{ mA}$	27	–	–	V
$V_{(BR)EBO}$	emitter-base breakdown voltage	open collector $I_E = 5\text{ mA}$	3.5	–	–	V
I_{CES}	collector leakage current	$V_{BE} = 0$ $V_{CE} = 27\text{ V}$	–	–	5	mA
h_{FE}	DC current gain	$I_C = 1\text{ A}$ $V_{CE} = 20\text{ V}$	15	–	–	
C_c	collector capacitance at $f = 1\text{ MHz}$	$I_E = I_e = 0$ $V_{CB} = 24\text{ V}$	–	23	–	pF
C_{re}	feedback capacitance at $f = 1\text{ MHz}$	$I_C = 0$ $V_{CE} = 24\text{ V}$	–	14	–	pF
C_{cf}	collector-flange capacitance		–	2	–	pF

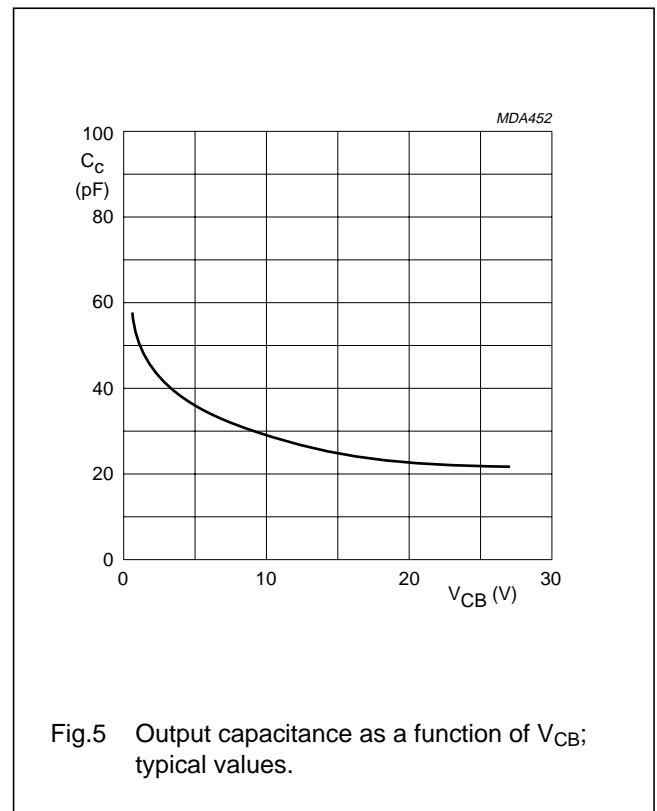
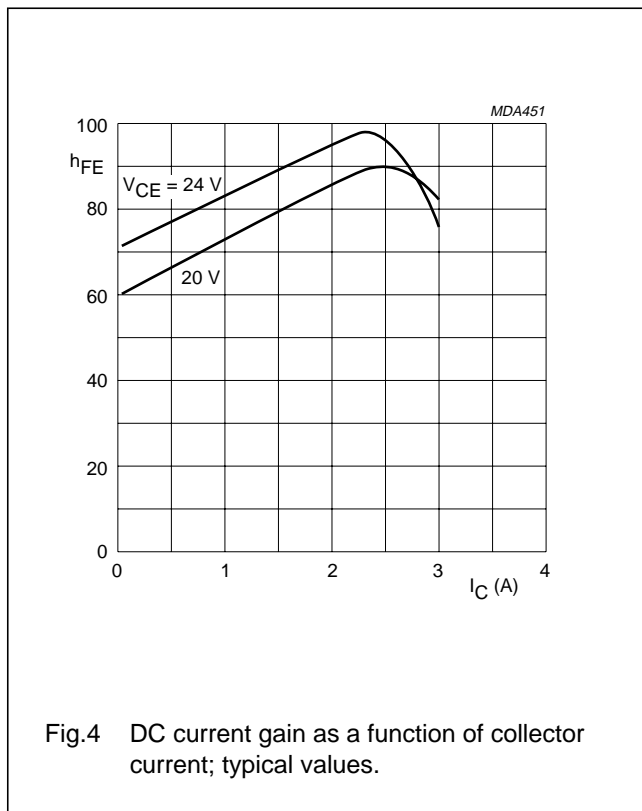

UHF power transistor

BLV98CE

APPLICATION INFORMATION

RF performance in a common emitter test circuit.

$T_h = 25\text{ }^\circ\text{C}$, $R_{th\text{ mb-h}} = 0.4\text{ K/W}$ unless otherwise specified.

MODE OF OPERATION	f (MHz)	V _{CE} (V)	I _{C(ZS)} (mA)	P _L (W)	G _P (dB)	η_c (%)
c.w. class-AB	960	24	30	15	> 7.5 typ. 8.5	> 50 typ. 55

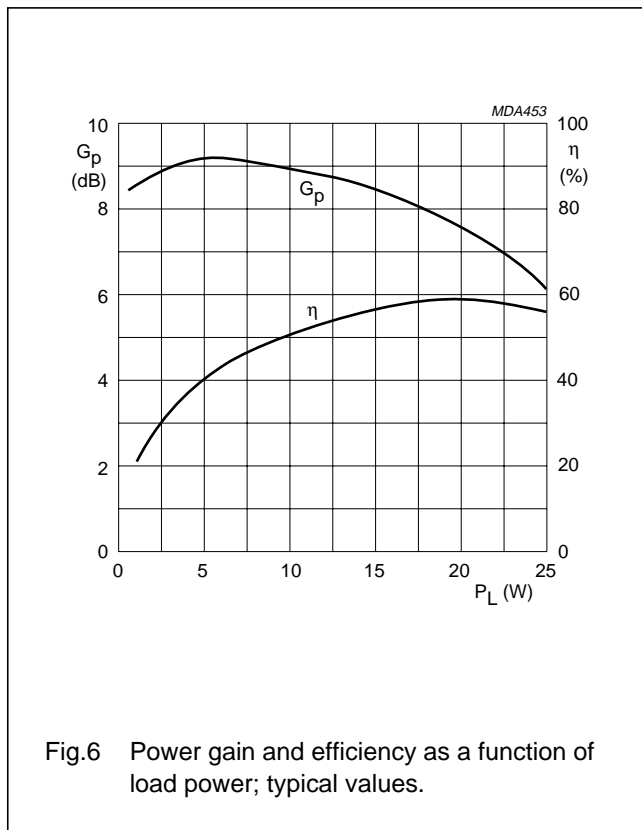

Fig.6 Power gain and efficiency as a function of load power; typical values.

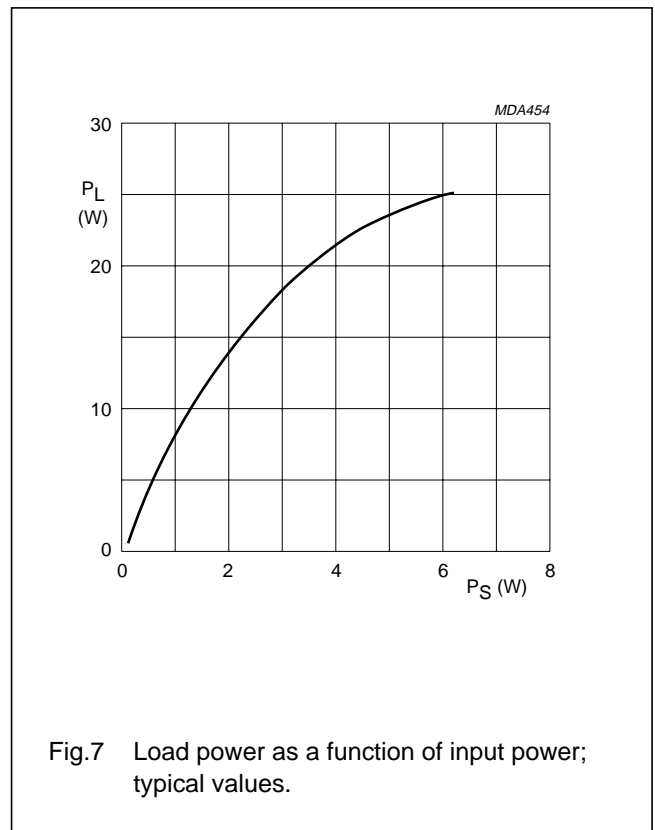

Fig.7 Load power as a function of input power; typical values.

Ruggedness in class-AB operation

The BLV98CE is capable of withstanding a load mismatch corresponding to $V_{SWR} = 50$ through all phases, under the following conditions: $V_{CE} = 24\text{ V}$, $I_{C(ZS)} = 30\text{ mA}$, $f = 960\text{ MHz}$ at rated output power.

UHF power transistor

BLV98CE

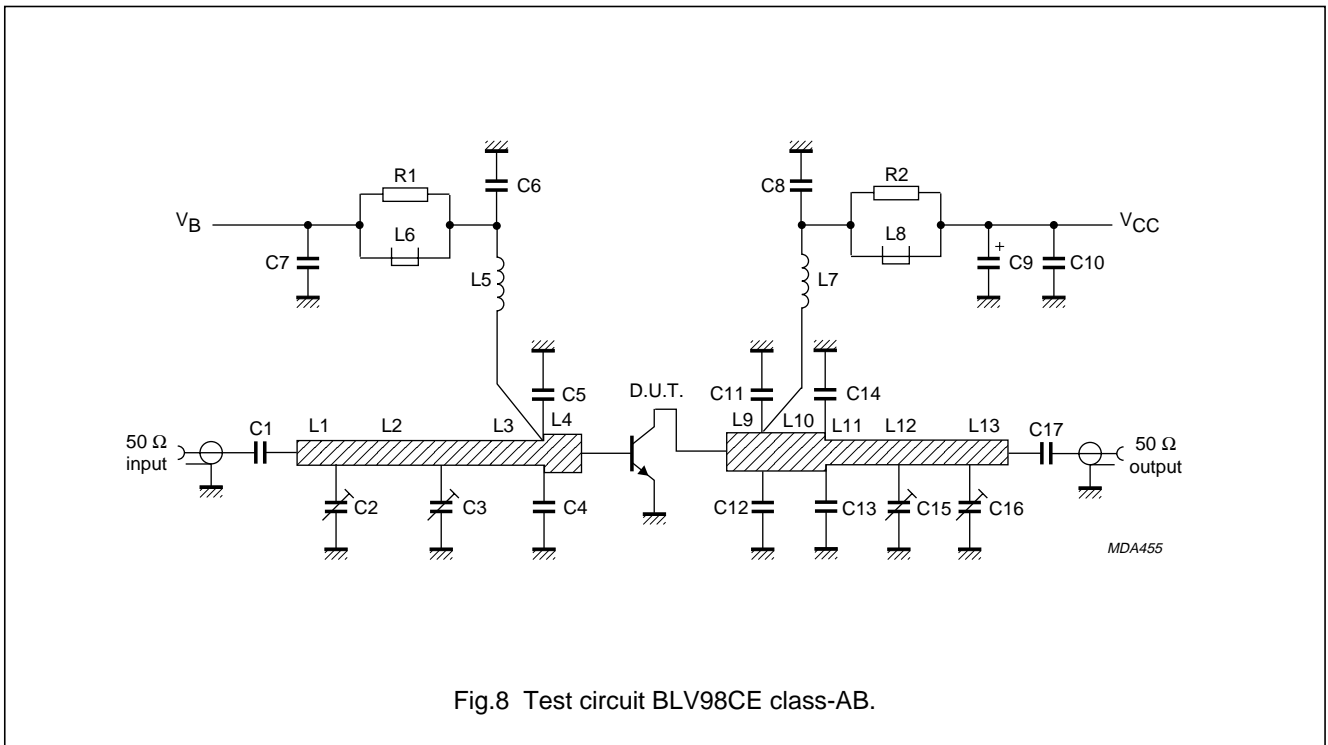

Fig.8 Test circuit BLV98CE class-AB.

UHF power transistor

BLV98CE

List of components (Fig.8)

DESIGNATION	DESCRIPTION	VALUE	DIMENSIONS	CATALOGUE NO.
C1, C6, C7, C8, C17	multilayer ceramic chip capacitor	330 pF		
C2, C3, C15, C16	film dielectric trimmer	1.4 to 5.5 pF		2222 809 09001
C4, C5	multilayer ceramic chip capacitor note 1	4.3 pF		
C9	35 V solid aluminium capacitor	2.2 μ F		2222 128 50228
C10	multilayer ceramic chip capacitor	3 \times 100 nF in parallel		
C11, C12	multilayer ceramic chip capacitor note 1	5.6 pF		
C13, C14	multilayer ceramic chip capacitor note 2	5.1 pF		
L1, L13	microstrip note 3	50 Ω	9.0 \times 2.4 mm	
L2, L12	microstrip note 3	50 Ω	23.0 \times 2.4 mm	
L3	microstrip note 3	50 Ω	16.0 \times 2.4 mm	
L4	microstrip note 3	43 Ω	3.0 \times 3.0 mm	
L5	3 turns enamelled 0.8 mm copper wire		int. dia. 3 mm length 5 mm leads 2 \times 5 mm	
L6, L8	grade 3B ferroxcube wide-band RF choke			4312 020 36642
L7	4 turns enamelled 0.8 mm copper wire		int. dia. 4 mm length 5 mm leads 2 \times 5 mm	
L9	microstrip note 3	43 Ω	3.5 \times 3.0 mm	
L10	microstrip note 3	43 Ω	11.0 \times 3.0 mm	
L11	microstrip note 3	50 Ω	4.5 \times 2.4 mm	
R1, R2	0.4 W metal film resistor	10 Ω		2322 151 71009

Notes

1. ATC capacitor type 100A or capacitor of the same quality.
2. ATC capacitor type 100B or capacitor of the same quality.
3. The microstrips are on a double copper-clad PCB with PTFE fibre-glass dielectric ($\epsilon_r = 2.2$); thickness $\frac{1}{32}$ inch.

UHF power transistor

BLV98CE

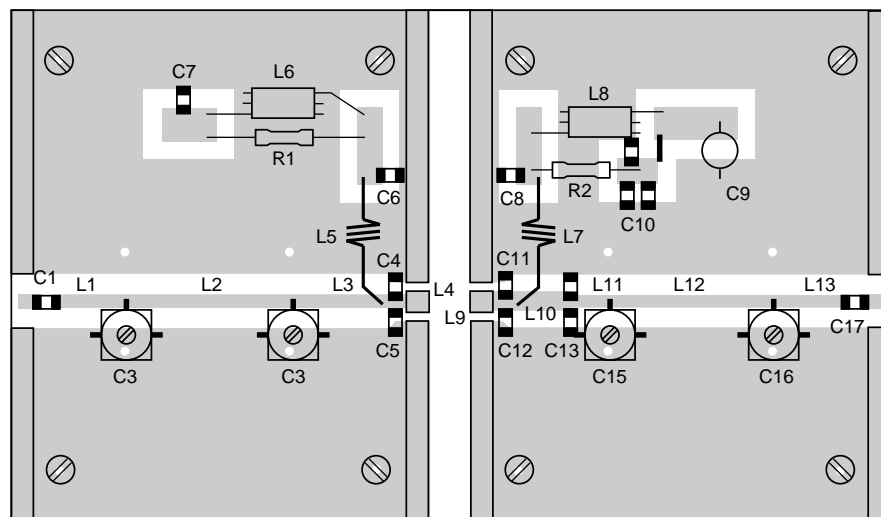
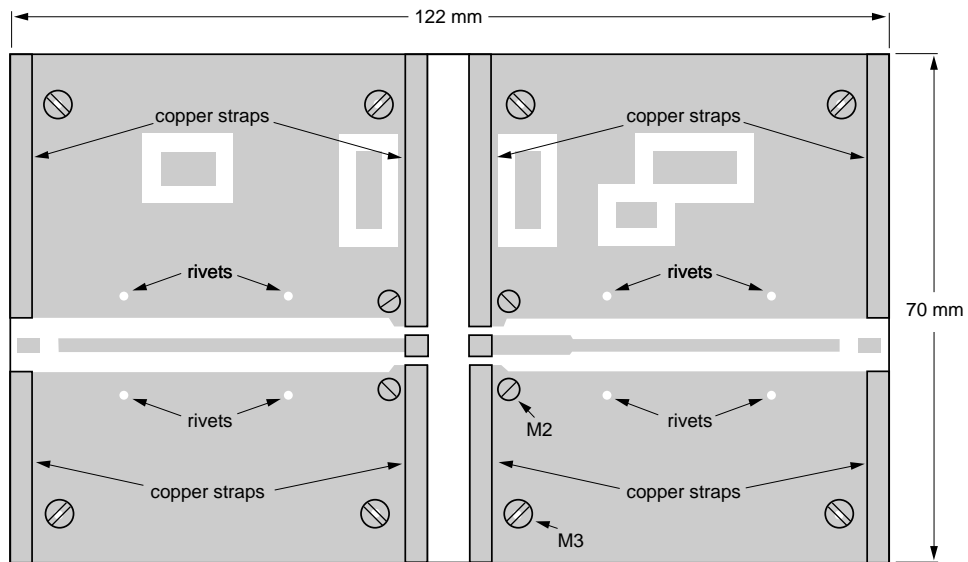

MDA456

The circuit and components are located on one side of the PTFE fibre-glass board, the other side being fully metallized, to serve as an earth. Earth connections are made by fixing screws, hollow rivets and copper straps around the board and under the emitters, to provide a direct contact between the component side and the ground plane.

Fig.9 Printed circuit board and component layout for 960 MHz test circuit.

UHF power transistor

BLV98CE

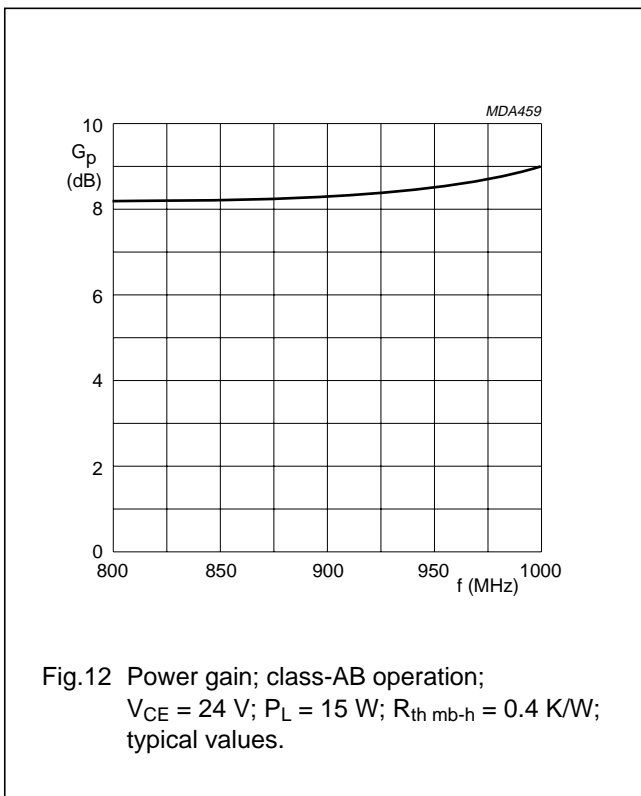
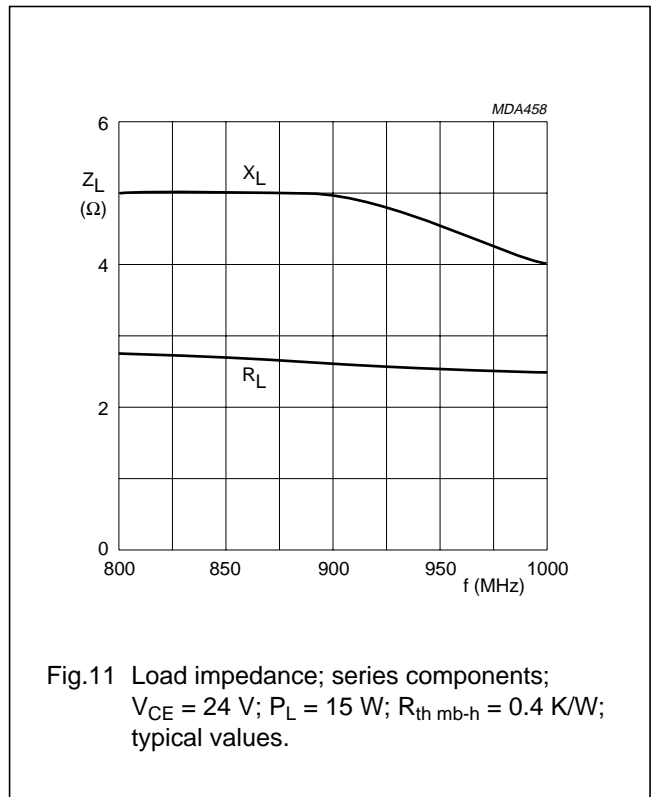
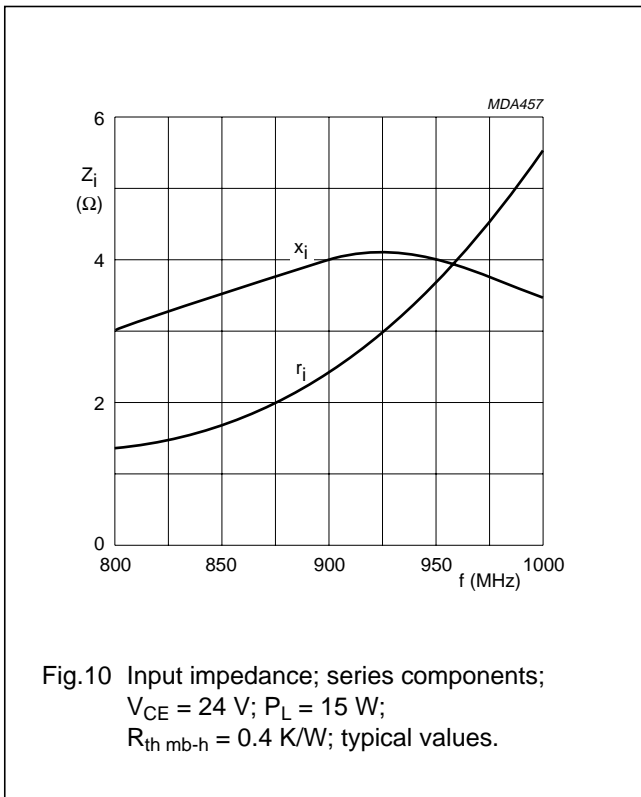

UHF power transistor

BLV98CE

PACKAGE OUTLINE

Flanged ceramic package; 2 mounting holes; 6 leads

SOT171A

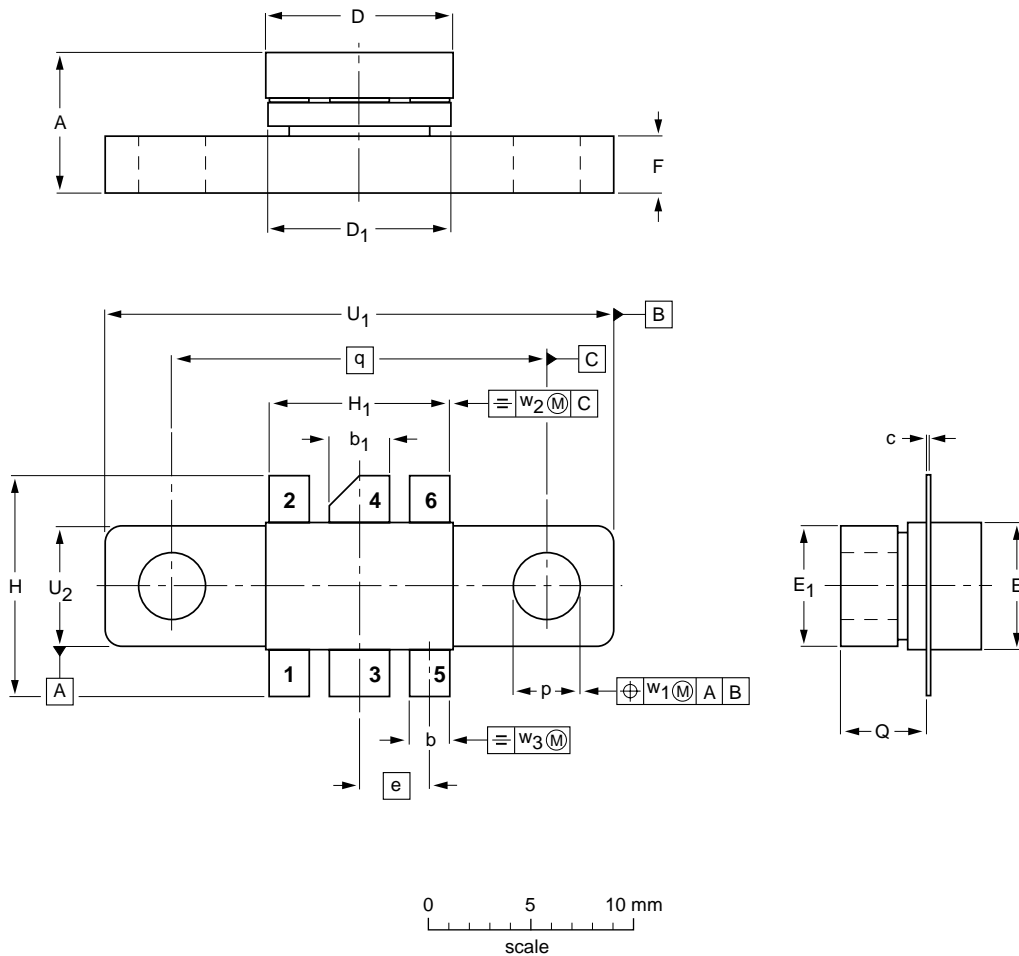

DIMENSIONS (millimetre dimensions are derived from the original inch dimensions)

UNIT	A	b	b ₁	c	D	D ₁	E	E ₁	e	F	H	H ₁	p	Q	q	U ₁	U ₂	w ₁	w ₂	w ₃
mm	6.81 6.07	2.15 1.85	3.20 2.89	0.16 0.07	9.25 9.04	9.30 8.99	5.95 5.74	6.00 5.70	3.58	3.05 2.54	11.31 10.54	9.27 9.01	3.43 3.17	4.32 4.11	18.42	24.90 24.63	6.00 5.70	0.51	1.02	0.26
inches	0.268 0.239	0.085 0.073	0.126 0.114	0.006 0.003	0.364 0.356	0.366 0.354	0.234 0.226	0.236 0.224	0.140	0.120 0.100	0.445 0.415	0.365 0.355	0.135 0.125	0.170 0.162	0.725	0.980 0.970	0.236 0.224	0.02	0.04	0.01

OUTLINE VERSION	REFERENCES				EUROPEAN PROJECTION	ISSUE DATE
	IEC	JEDEC	EIAJ			
SOT171A						97-06-28

UHF power transistor

BLV98CE

DEFINITIONS

Data Sheet Status	
Objective specification	This data sheet contains target or goal specifications for product development.
Preliminary specification	This data sheet contains preliminary data; supplementary data may be published later.
Product specification	This data sheet contains final product specifications.
Limiting values	
Limiting values given are in accordance with the Absolute Maximum Rating System (IEC 134). Stress above one or more of the limiting values may cause permanent damage to the device. These are stress ratings only and operation of the device at these or at any other conditions above those given in the Characteristics sections of the specification is not implied. Exposure to limiting values for extended periods may affect device reliability.	
Application information	
Where application information is given, it is advisory and does not form part of the specification.	

LIFE SUPPORT APPLICATIONS

These products are not designed for use in life support appliances, devices, or systems where malfunction of these products can reasonably be expected to result in personal injury. Philips customers using or selling these products for use in such applications do so at their own risk and agree to fully indemnify Philips for any damages resulting from such improper use or sale.

SUNSTAR 商斯达实业集团是集研发、生产、工程、销售、代理经销、技术咨询、信息服务等为一体的高科技企业，是专业高科技电子产品生产厂家，是具有 10 多年历史的专业电子元器件供应商，是中国最早和最大的仓储式连锁规模经营大型综合电子零部件代理分销商之一，是一家专业代理和分销世界各大品牌 IC 芯片和电子元器件的连锁经营综合性国际公司，专业经营进口、国产名厂名牌电子元件，型号、种类齐全。在香港、北京、深圳、上海、西安、成都等全国主要电子市场设有直属分公司和产品展示展销窗口门市部专卖店及代理分销商，已在全国范围内建成强大统一的供货和代理分销网络。我们专业代理经销、开发生产电子元器件、集成电路、传感器、微波光电元器件、工控机/DOC/DOM 电子盘、专用电路、单片机开发、MCU/DSP/ARM/FPGA 软件硬件、二极管、三极管、模块等，是您可靠的一站式现货配套供应商、方案提供商、部件功能模块开发配套商。商斯达实业公司拥有庞大的资料库，有数位毕业于著名高校——有中国电子工业摇篮之称的西安电子科技大学（西军电）并长期从事国防尖端科技研究的高级工程师为您精挑细选、量身订做各种高科技电子元器件，并解决各种技术问题。

微波光电部专业代理经销高频、微波、光纤、光电元器件、组件、部件、模块、整机；电磁兼容元器件、材料、设备；微波 CAD、EDA 软件、开发测试仿真工具；微波、光纤仪器仪表。欢迎国外高科技微波、光纤厂商将优秀产品介绍到中国、共同开拓市场。长期大量现货专业批发高频、微波、卫星、光纤、电视、CATV 器件：晶振、VCO、连接器、PIN 开关、变容二极管、开关二极管、低噪晶体管、功率电阻及电容、放大器、功率管、MMIC、混频器、耦合器、功分器、振荡器、合成器、衰减器、滤波器、隔离器、环行器、移相器、调制解调器；光电子元件和组件：红外发射管、红外接收管、光电开关、光敏管、发光二极管和发光二极管组件、半导体激光二极管和激光器组件、光电探测器和光接收组件、光发射接收模块、光纤激光器和光放大器、光调制器、光开关、DWDM 用光发射和接收器件、用户接入系统光收发器件与模块、光纤连接器、光纤跳线/尾纤、光衰减器、光纤适配器、光隔离器、光耦合器、光环行器、光复用器/转换器；无线收发芯片和模组、蓝牙芯片和模组。

更多产品请看本公司产品专用销售网站：

商斯达中国传感器科技信息网：<http://www.sensor-ic.com/>

商斯达工控安防网：<http://www.pc-ps.net/>

商斯达电子元器件网：<http://www.sunstare.com/>

商斯达微波光电产品网：[HTTP://www.rfoe.net/](http://www.rfoe.net/)

商斯达消费电子产品网：<http://www.icasic.com/>

商斯达实业科技产品网：<http://www.sunstars.cn/> 微波元器件销售热线：

地址：深圳市福田区福华路福庆街鸿图大厦 1602 室

电话：0755-82884100 83397033 83396822 83398585

传真：0755-83376182 (0) 13823648918 MSN: SUNS8888@hotmail.com

邮编：518033 E-mail:szss20@163.com QQ: 195847376

深圳赛格展销部：深圳华强北路赛格电子市场 2583 号 电话：0755-83665529 25059422

技术支持：0755-83394033 13501568376

欢迎索取免费详细资料、设计指南和光盘；产品凡多，未能尽录，欢迎来电查询。

北京分公司：北京海淀区知春路 132 号中发电子大厦 3097 号

TEL: 010-81159046 82615020 13501189838 FAX: 010-62543996

上海分公司：上海市北京东路 668 号上海赛格电子市场 D125 号

TEL: 021-28311762 56703037 13701955389 FAX: 021-56703037

西安分公司：西安高新开发区 20 所(中国电子科技集团导航技术研究所)

西安劳动南路 88 号电子商城二楼 D23 号

TEL: 029-81022619 13072977981 FAX:029-88789382