

To all our customers

Regarding the change of names mentioned in the document, such as Hitachi Electric and Hitachi XX, to Renesas Technology Corp.

The semiconductor operations of Mitsubishi Electric and Hitachi were transferred to Renesas Technology Corporation on April 1st 2003. These operations include microcomputer, logic, analog and discrete devices, and memory chips other than DRAMs (flash memory, SRAMs etc.) Accordingly, although Hitachi, Hitachi, Ltd., Hitachi Semiconductors, and other Hitachi brand names are mentioned in the document, these names have in fact all been changed to Renesas Technology Corp. Thank you for your understanding. Except for our corporate trademark, logo and corporate statement, no changes whatsoever have been made to the contents of the document, and these changes do not constitute any alteration to the contents of the document itself.

Renesas Technology Home Page: <http://www.renesas.com>

Renesas Technology Corp.
Customer Support Dept.
April 1, 2003

Cautions

Keep safety first in your circuit designs!

1. Renesas Technology Corporation puts the maximum effort into making semiconductor products better and more reliable, but there is always the possibility that trouble may occur with them. Trouble with semiconductors may lead to personal injury, fire or property damage.

Remember to give due consideration to safety when making your circuit designs, with appropriate measures such as (i) placement of substitutive, auxiliary circuits, (ii) use of nonflammable material or (iii) prevention against any malfunction or mishap.

Notes regarding these materials

1. These materials are intended as a reference to assist our customers in the selection of the Renesas Technology Corporation product best suited to the customer's application; they do not convey any license under any intellectual property rights, or any other rights, belonging to Renesas Technology Corporation or a third party.
2. Renesas Technology Corporation assumes no responsibility for any damage, or infringement of any third-party's rights, originating in the use of any product data, diagrams, charts, programs, algorithms, or circuit application examples contained in these materials.
3. All information contained in these materials, including product data, diagrams, charts, programs and algorithms represents information on products at the time of publication of these materials, and are subject to change by Renesas Technology Corporation without notice due to product improvements or other reasons. It is therefore recommended that customers contact Renesas Technology Corporation or an authorized Renesas Technology Corporation product distributor for the latest product information before purchasing a product listed herein.
The information described here may contain technical inaccuracies or typographical errors. Renesas Technology Corporation assumes no responsibility for any damage, liability, or other loss rising from these inaccuracies or errors.
Please also pay attention to information published by Renesas Technology Corporation by various means, including the Renesas Technology Corporation Semiconductor home page (<http://www.renesas.com>).
4. When using any or all of the information contained in these materials, including product data, diagrams, charts, programs, and algorithms, please be sure to evaluate all information as a total system before making a final decision on the applicability of the information and products. Renesas Technology Corporation assumes no responsibility for any damage, liability or other loss resulting from the information contained herein.
5. Renesas Technology Corporation semiconductors are not designed or manufactured for use in a device or system that is used under circumstances in which human life is potentially at stake. Please contact Renesas Technology Corporation or an authorized Renesas Technology Corporation product distributor when considering the use of a product contained herein for any specific purposes, such as apparatus or systems for transportation, vehicular, medical, aerospace, nuclear, or undersea repeater use.
6. The prior written approval of Renesas Technology Corporation is necessary to reprint or reproduce in whole or in part these materials.
7. If these products or technologies are subject to the Japanese export control restrictions, they must be exported under a license from the Japanese government and cannot be imported into a country other than the approved destination.
Any diversion or reexport contrary to the export control laws and regulations of Japan and/or the country of destination is prohibited.
8. Please contact Renesas Technology Corporation for further details on these materials or the products contained therein.

HN58X24512I

Two-wire serial interface
512k EEPROM (64-kword × 8-bit)



ADE-203-1239B (Z)
Preliminary
Rev. 0.2
Apr. 11, 2002

Description

HN58X24512I is the two-wire serial interface EEPROM (Electrically Erasable and Programmable ROM). It realizes high speed, low power consumption and a high level of reliability by employing advanced MNOS memory technology and CMOS process and low voltage circuitry technology. It also has a 128-byte page programming function to make it's write operation faster.

Note: Hitachi's serial EEPROM are authorized for using consumer applications such as cellular phone, camcorders, audio equipment. Therefore, please contact Hitachi's sales office before using industrial applications such as automotive systems, embedded controllers, and meters.

Features

- Single supply: 1.8 V to 5.5 V
- Two-wire serial interface (I²C™ serial bus*1)
- Clock frequency: 1 MHz (2.5 V to 5.5 V)/400 kHz (1.8 V to 2.5 V)
- Power dissipation:
 - Standby: 3 μA (max)
 - Active (Read): 2 mA (max)
 - Active (Write): 5 mA (max)
- Automatic page write: 128-byte/page
- Write cycle time: 10 ms (2.5 V to 5.5 V)/15 ms (1.8 V to 2.5 V)
- Endurance: 10⁵ Cycles (Page write mode)
- Data retention: 10 Years

Preliminary: The specification of this device are subject to change without notice. Please contact your nearest Hitachi's Sales Dept. regarding specification.

HN58X24512I

- Small size packages: SOP-8pin (200 mil-wide)
- Shipping tape and reel: 1,500 IC/reel
- Temperature range: -40 to +85°C

Note: 1. I²C is a trademark of Philips Corporation.

Ordering Information

Type No.	Internal organization	Operating voltage	Frequency	Package
HN58X24512FPI	512k bit (65536× 8-bit)	2.5 V to 5.5 V	1 MHz	200 mil 8-pin plastic SOP (FP-8DF)
		1.8 V to 2.5 V	400 kHz	

Pin Arrangement

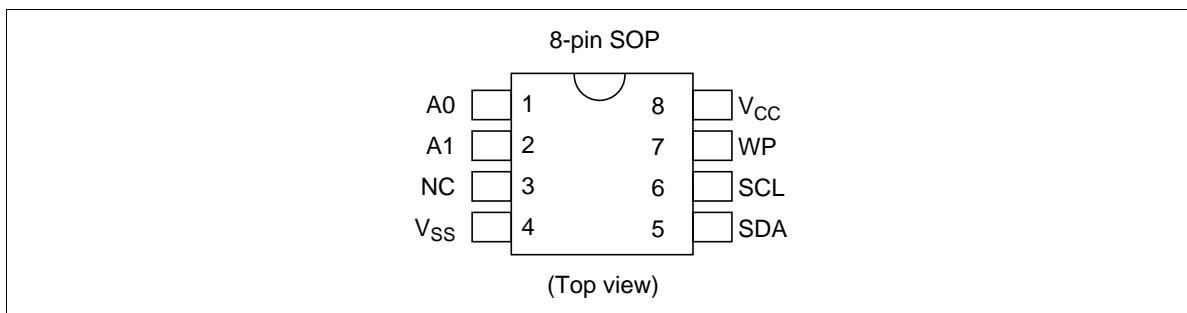

Pin Description

Pin name	Function
A0, A1	Device address
SCL	Serial clock input
SDA	Serial data input/output
WP	Write protect
V _{CC}	Power supply
V _{SS}	Ground
NC	No connection

Block Diagram

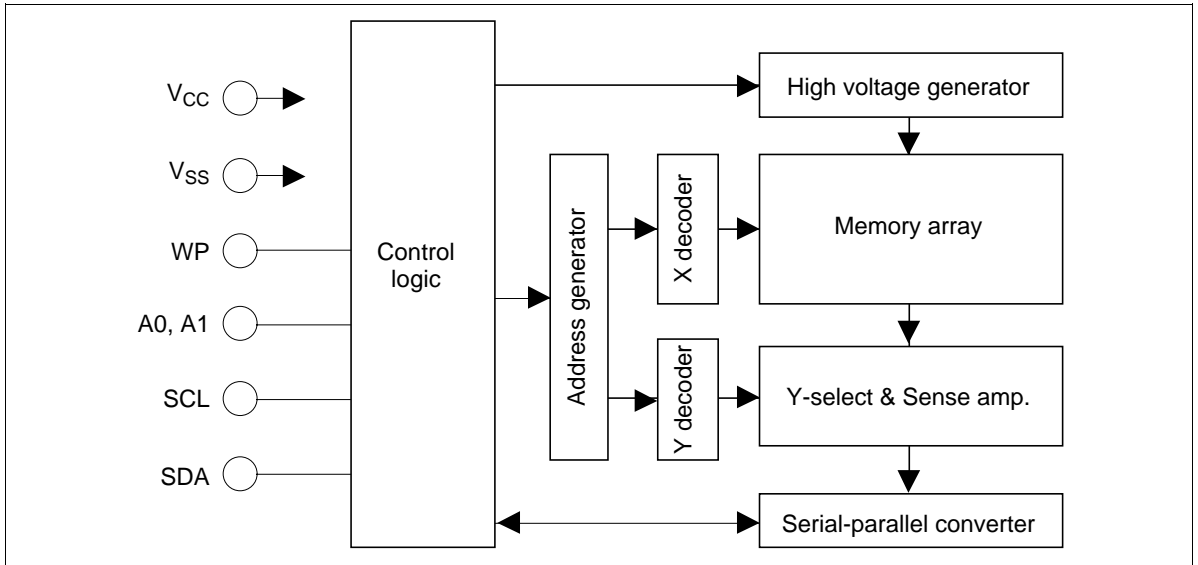

Absolute Maximum Ratings

Parameter	Symbol	Value	Unit
Supply voltage relative to V_{SS}	V_{CC}	-0.6 to +7.0	V
Input voltage relative to V_{SS}	V_{in}	-0.5* ² to +7.0* ³	V
Operating temperature range* ¹	T_{opr}	-40 to +85	°C
Storage temperature range	T_{stg}	-65 to +125	°C

Notes: 1. Including electrical characteristics and data retention.

2. V_{in} (min): -3.0 V for pulse width \leq 50 ns.

3. Should not exceed $V_{CC} + 1.0$ V.

DC Operating Conditions

Parameter	Symbol	Min	Typ	Max	Unit
Supply voltage	V_{CC}	1.8	—	5.5	V
	V_{SS}	0	0	0	V
Input high voltage	V_{IH}	$V_{CC} \times 0.7$	—	$V_{CC} + 0.5$ * ²	V
Input low voltage	V_{IL}	-0.3* ¹	—	$V_{CC} \times 0.3$	V
Operating temperature	T_{opr}	-40	—	85	°C

Notes: 1. V_{IL} (min): -1.0 V for pulse width \leq 50 ns.

2. V_{IH} (max): $V_{CC} + 1.0$ V for pulse width \leq 50 ns.

DC Characteristics (Ta = -40 to +85°C, V_{CC} = 1.8 V to 5.5 V)

Parameter	Symbol	Min	Typ	Max	Unit	Test conditions
Input leakage current	I _{LI}	—	—	2.0	μA	V _{CC} = 5.5 V, Vin = 0 to 5.5 V (SCL, SDA)
		—	—	20	μA	V _{CC} = 5.5 V, Vin = 0 to 5.5 V (A0, A1, WP)
Output leakage current	I _{LO}	—	—	2.0	μA	V _{CC} = 5.5 V, Vout = 0 to 5.5 V
Standby V _{CC} current	I _{SB}	—	1.0	3.0	μA	Vin = V _{SS} or V _{CC}
Read V _{CC} current	I _{CC1}	—	—	2.0	mA	V _{CC} = 5.5 V, Read at 400 kHz
Write V _{CC} current	I _{CC2}	—	—	5.0	mA	V _{CC} = 5.5 V, Write at 400 kHz
Output low voltage	V _{OL2}	—	—	0.4	V	V _{CC} = 4.5 to 5.5 V, I _{OL} = 1.6 mA V _{CC} = 2.5 to 4.5 V, I _{OL} = 0.8 mA V _{CC} = 1.8 to 2.5 V, I _{OL} = 0.4 mA
		V _{OL1}	—	—	0.2	V

Capacitance (Ta = 25°C, f = 1 MHz)

Parameter	Symbol	Min	Typ	Max	Unit	Test conditions
Input capacitance (A0 to A1, SCL, WP)	C _{in} *1	—	—	6.0	pF	Vin = 0 V
Output capacitance (SDA)	C _{I/O} *1	—	—	6.0	pF	Vout = 0 V

Note: 1. This parameter is sampled and not 100% tested.

AC Characteristics ($T_a = -40$ to $+85^\circ\text{C}$, $V_{CC} = 1.8$ to 5.5 V)

Test Conditions

- Input pules levels:
 - $V_{IL} = 0.2 \times V_{CC}$
 - $V_{IH} = 0.8 \times V_{CC}$
- Input rise and fall time: ≤ 20 ns
- Input and output timing reference levels: $0.5 \times V_{CC}$
- Output load: TTL Gate + 100 pF

Parameter	Symbol	$V_{CC} = 1.8$ to 5.5 V		$V_{CC} = 2.5$ to 5.5 V		Unit	Notes
		Min	Max	Min	Max		
Clock frequency	f_{SCL}	—	400	—	1000	kHz	
Clock pulse width low	t_{LOW}	1200	—	600	—	ns	
Clock pulse width high	t_{HIGH}	600	—	400	—	ns	
Noise suppression time	t_I	—	50	—	50	ns	1
Access time	t_{AA}	100	900	100	550	ns	
Bus free time for next mode	t_{BUF}	1200	—	500	—	ns	
Start hold time	$t_{HD,STA}$	600	—	250	—	ns	
Start setup time	$t_{SU,STA}$	600	—	250	—	ns	
Data in hold time	$t_{HD,DAT}$	0	—	0	—	ns	
Data in setup time	$t_{SU,DAT}$	100	—	100	—	ns	
Input rise time	t_R	—	300	—	300	ns	1
Input fall time	t_F	—	300	—	100	ns	1
Stop setup time	$t_{SU,STO}$	600	—	250	—	ns	
Data out hold time	t_{DH}	50	—	50	—	ns	
Write cycle time	t_{WC}	—	15	—	10	ms	2

Notes: 1. This parameter is sampled and not 100% tested.

2. t_{WC} is the time from a stop condition to the end of internally controlled write cycle.

Timing Waveforms

Bus Timing

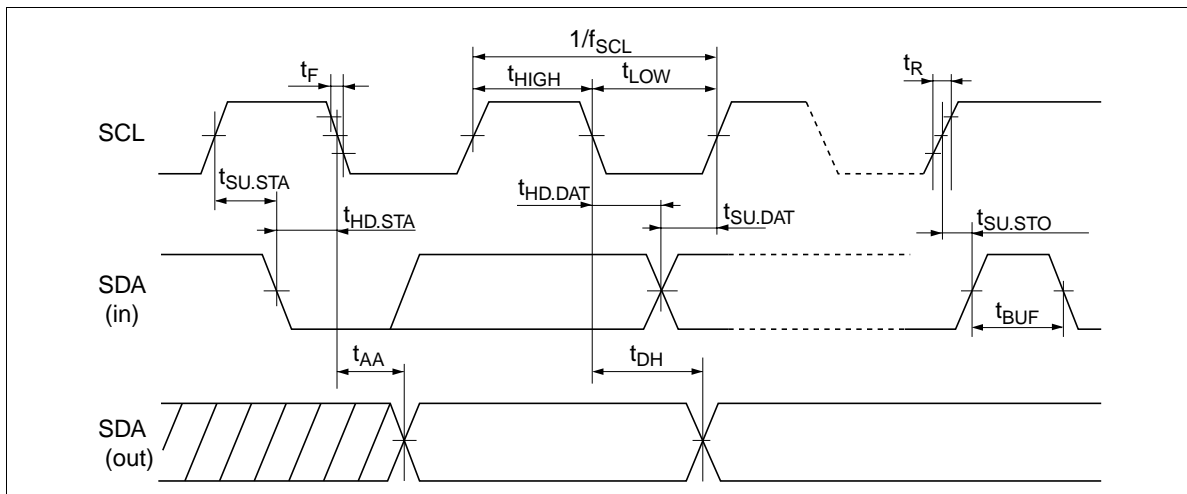

Write Cycle Timing

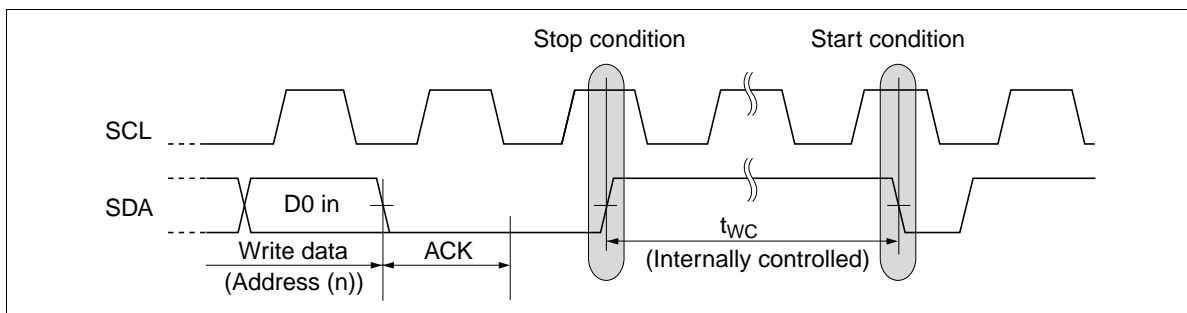

Pin Function

Serial Clock (SCL)

The SCL pin is used to control serial input/output data timing. The SCL input is used to positive edge clock data into EEPROM device and negative edge clock data out of each device. Maximum clock rate is 1 MHz.

Serial Input/Output Data (SDA)

The SDA pin is bidirectional for serial data transfer. The SDA pin needs to be pulled up by resistor as that pin is open-drain driven structure. Use proper resistor value for your system by considering V_{OL} , I_{OL} and the SDA pin capacitance. Except for a start condition and a stop condition, which will be discussed later, the SDA transition needs to be completed during SCL low period.

Data Validity (SDA data change timing waveform)

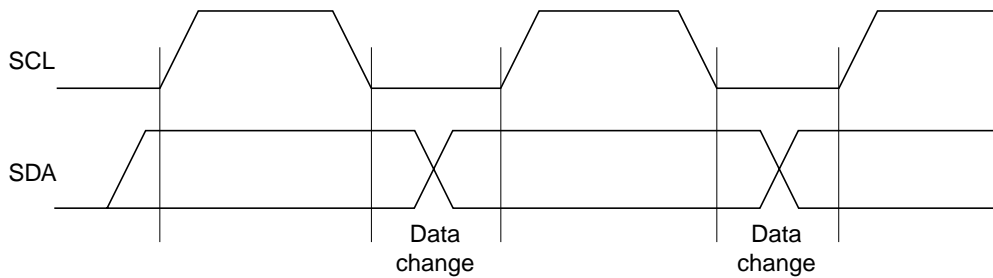

Note: High-to-low and low-to-high change of SDA should be done during SCL low periods.

Device Address (A0, A1)

Up to four devices can be addressed on the same bus by setting the levels on these pins to different combinations. The levels on these pins are compared with the device address code which are inputted through the SDA pin. This device is selected if the compare is successfully done. These pins are internally pulled down to V_{SS} . The device reads these pins as low if unconnected.

Pin Connections for A0, A1

Memory size	Max connect number	Pin connection		Note
		A1	A0	
512k bit	4	V_{CC}/V_{SS}^{*1}	V_{CC}/V_{SS}	

Note: 1. " V_{CC}/V_{SS} " means that device address pin should be connected to V_{CC} or V_{SS} . The A1 and A0 are read as V_{SS} , if left unconnected.

Write Protect (WP)

When the Write Protect pin (WP) is high, the write protection feature is enabled and operates as shown in the following table. When the WP is low, write operation for all memory arrays are allowed. The read operation is always activated irrespective of the WP pin status. When left unconnected, the WP input is read as V_{IL} because the WP pin is internally pulled down to V_{SS} .

Write Protect Area

WP pin status	Write protect area
V_{IH}	Full (512k bit)
V_{IL}	Normal read/write operation

Functional Description

Start Condition

A high-to-low transition of the SDA with the SCL high is needed in order to start read, write operation. (See start condition and stop condition)

Stop Condition

A low-to-high transition of the SDA with the SCL high is a stop condition. The stand-by operation starts after a read sequence by a stop condition. In the case of write operation, a stop condition terminates the write data inputs and place the device in a internally-timed write cycle to the memories. After the internally-timed write cycle which is specified as t_{WC} , the device enters a standby mode. (See write cycle timing)

Start Condition and Stop Condition

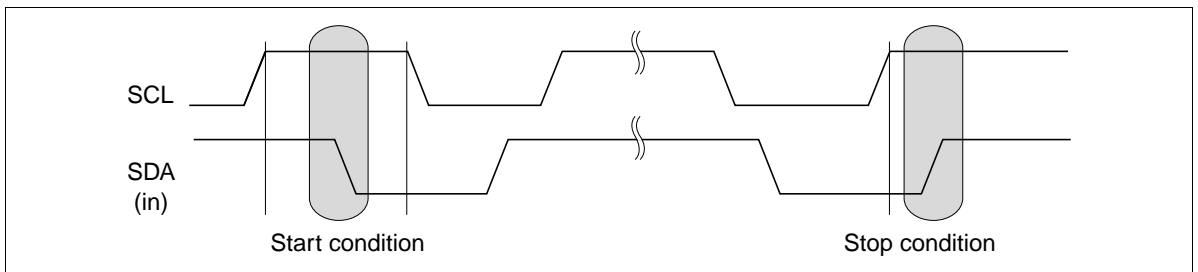

Acknowledge

All addresses and data words are serially transmitted to and from in 8-bit words. The receiver sends a zero to acknowledge that it has received each word. This happens during ninth clock cycle. The transmitter keeps bus open to receive acknowledgment from the receiver at the ninth clock. In the write operation, EEPROM sends a zero to acknowledge after receiving every 8-bit words. In the read operation, EEPROM sends a zero to acknowledge after receiving the device address word. After sending read data, the EEPROM waits acknowledgment by keeping bus open. If the EEPROM receives zero as an acknowledge, it sends read data of next address. If the EEPROM receives acknowledgment "1" (no acknowledgment) and a following stop condition, it stops the read operation and enters a stand-by mode. If the EEPROM receives neither acknowledgment "0" nor a stop condition, the EEPROM keeps bus open without sending read data.

Acknowledge Timing Waveform

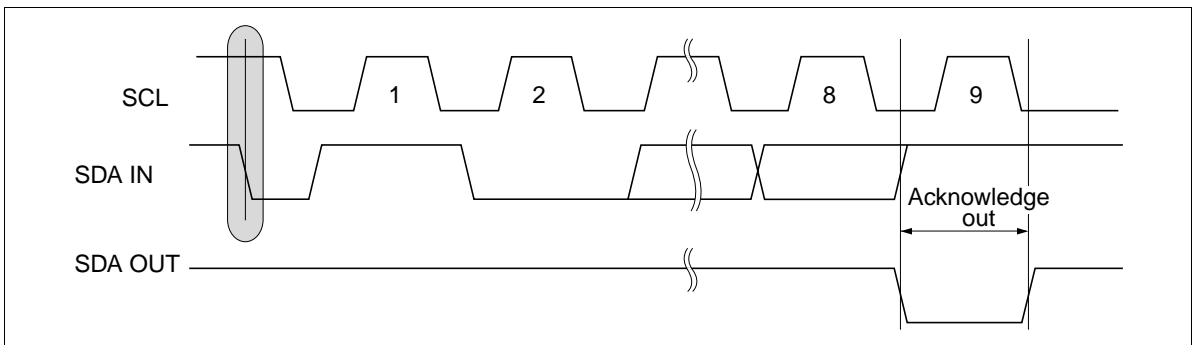

Device Addressing

The EEPROM device requires an 8-bit device address word following a start condition to enable the chip for a read or a write operation. The device address word consists of 4-bit device code, 3-bit device address code and 1-bit read/write(R/W) code. The most significant 4-bit of the device address word are used to distinguish device type and this EEPROM uses “1010” fixed code. The device address word is followed by the 3-bit device address code. The upper bit of device address can be set any data. The device address code selects one device out of all devices which are connected to the bus. This means that the device is selected if the inputted 3-bit device address code is equal to the corresponding hard-wired A1 to A0 pin status. The eighth bit of the device address word is the read/write(R/W) bit. A write operation is initiated if this bit is low and a read operation is initiated if this bit is high. Upon a compare of the device address word, the EEPROM enters the read or write operation after outputting the zero as an acknowledge. The EEPROM turns to a stand-by state if the device code is not “1010” or device address code doesn’t coincide with status of the correspond hard-wired device address pins A0 to A1.

Device Address Word

Device address word (8-bit)								
Device code (fixed)				Device address code			R/W code*1	
128k, 256k	1	0	1	0	0*2	A1	A0	R/W

Notes: 1. R/W=“1” is read and R/W = “0” is write.

2. Don't care bit.

Write Operations

Byte Write:

A write operation requires an 8-bit device address word with R/W = "0". Then the EEPROM sends acknowledgment "0" at the ninth clock cycle. After these, the EEPROM receives 2 sequence 8-bit memory address words. Upon receipt of this memory address, the EEPROM outputs acknowledgment "0" and receives a following 8-bit write data. After receipt of write data, the EEPROM outputs acknowledgment "0". If the EEPROM receives a stop condition, the EEPROM enters an internally-timed write cycle and terminates receipt of SCL, SDA inputs until completion of the write cycle. The EEPROM returns to a standby mode after completion of the write cycle.

Byte Write Operation

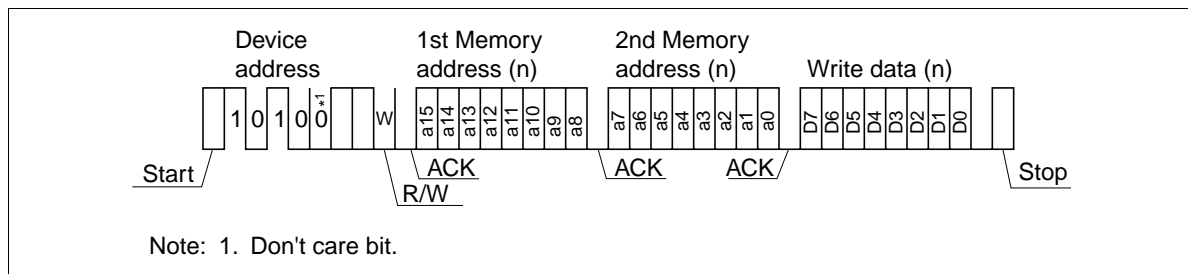

Page Write:

The EEPROM is capable of the page write operation which allows any number of bytes up to 128 bytes to be written in a single write cycle. The page write is the same sequence as the byte write except for inputting the more write data. The page write is initiated by a start condition, device address word, memory address(n) and write data (Dn) with every ninth bit acknowledgment. The EEPROM enters the page write operation if the EEPROM receives more write data (Dn+1) instead of receiving a stop condition. The a0 to a6 address bits are automatically incremented upon receiving write data (Dn+1). The EEPROM can continue to receive write data up to 128 bytes. If the a0 to a6 address bits reaches the last address of the page, the a0 to a6 address bits will roll over to the first address of the same page and previous write data will be overwritten. Upon receiving a stop condition, the EEPROM stops receiving write data and enters internally-timed write cycle.

Page Write Operation

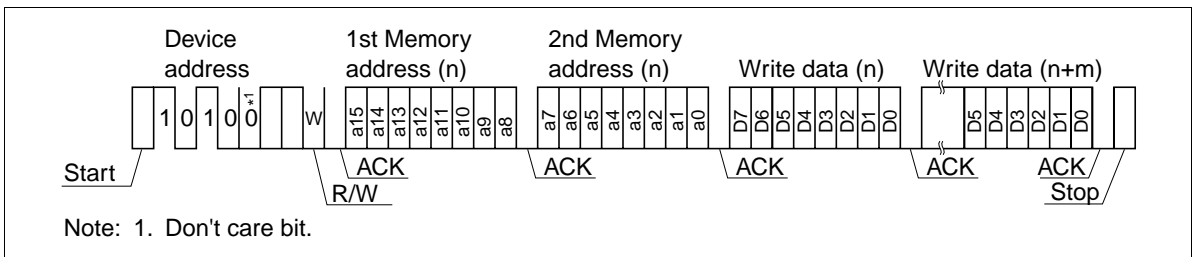

Acknowledge Polling:

Acknowledge polling feature is used to show if the EEPROM is in a internally-timed write cycle or not. This feature is initiated by the stop condition after inputting write data. This requires the 8-bit device address word following the start condition during a internally-timed write cycle. Acknowledge polling will operate R/W code = "0". Acknowledgment "1" (no acknowledgment) shows the EEPROM is in a internally-timed write cycle and acknowledgment "0" shows that the internally-timed write cycle has completed. See Write Cycle Polling using ACK.

Write Cycle Polling Using ACK

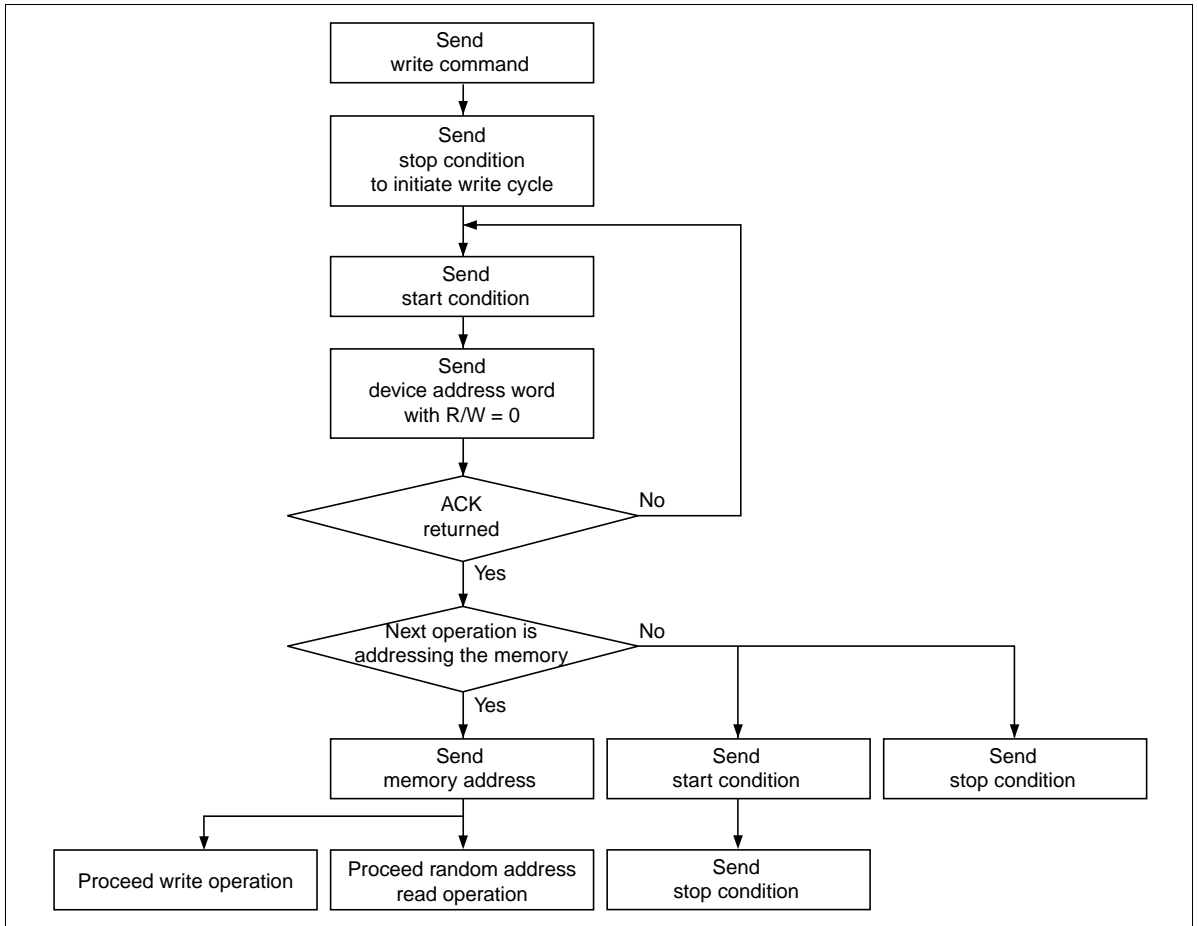

Read Operation

There are three read operations: current address read, random read, and sequential read. Read operations are initiated the same way as write operations with the exception of R/W = "1".

Current Address Read:

The internal address counter maintains the last address accessed during the last read or write operation, with incremented by one. Current address read accesses the address kept by the internal address counter. After receiving a start condition and the device address word (R/W is "1"), the EEPROM outputs the 8-bit current address data from the most significant bit following acknowledgment "0" If the EEPROM receives acknowledgment "1" (no acknowledgment) and a following stop condition, the EEPROM stops the read operation and is turned to a standby state. In case the EEPROM have accessed the last address of the last page at previous read operation, the current address will roll over and returns to zero address. In case the EEPROM have accessed the last address of the page at previous write operation, the current address will roll over within page addressing and returns to the first address in the same page. The current address is valid while power is on. The current address after power on will be indefinite. The random read operation described below is necessary to define the memory address.

Current Address Read Operation

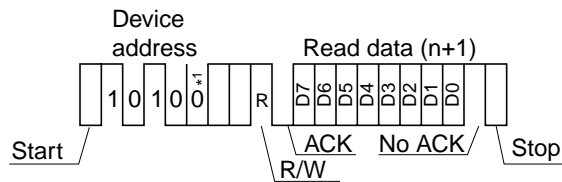

Note: 1. Don't care bit.

Random Read:

This is a read operation with defined read address. A random read requires a dummy write to set read address. The EEPROM receives a start condition, device address word (R/W=0) and memory address 2×8 -bit sequentially. The EEPROM outputs acknowledgment "0" after receiving memory address then enters a current address read with receiving start condition. The EEPROM outputs the read data of the address which was defined in the dummy write operation. After receiving acknowledgment "1"(no acknowledgment) and a following stop condition, the EEPROM stops the random read operation and returns to a standby state.

Random Read Operation

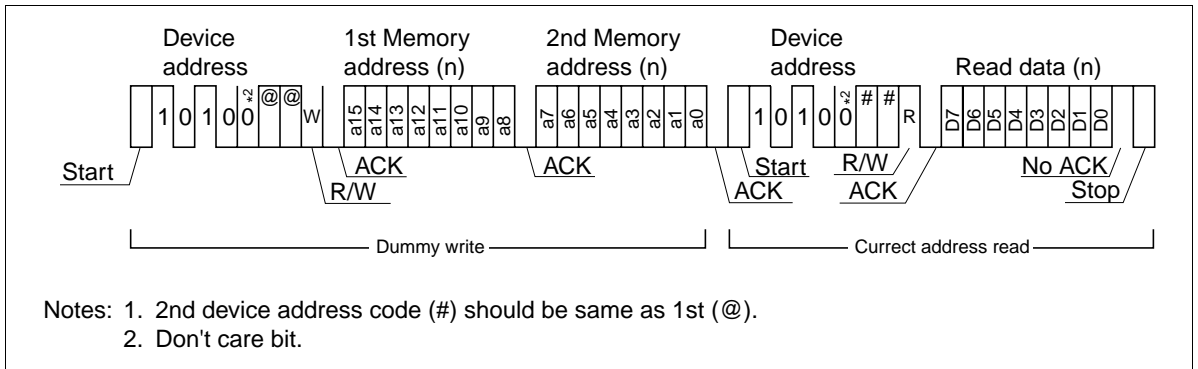

Sequential Read:

Sequential reads are initiated by either a current address read or a random read. If the EEPROM receives acknowledgment “0” after 8-bit read data, the read address is incremented and the next 8-bit read data are coming out. This operation can be continued as long as the EEPROM receives acknowledgment “0”. The address will roll over and returns address zero if it reaches the last address of the last page. The sequential read can be continued after roll over. The sequential read is terminated if the EEPROM receives acknowledgment “1” (no acknowledgment) and a following stop condition.

Sequential Read Operation

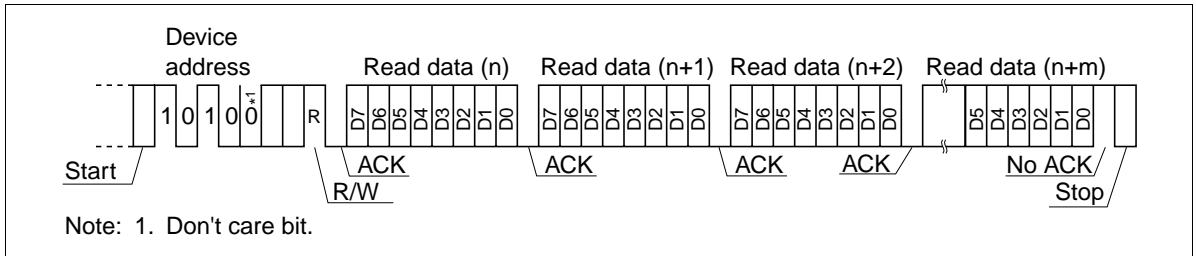

Notes

Data Protection at V_{CC} On/Off

When V_{CC} is turned on or off, noise on the SCL and SDA inputs generated by external circuits (CPU, etc) may act as a trigger and turn the EEPROM to unintentional program mode. To prevent this unintentional programming, this EEPROM have a power on reset function. Be careful of the notices described below in order for the power on reset function to operate correctly.

- SCL and SDA should be fixed to V_{CC} or V_{SS} during V_{CC} on/off. Low to high or high to low transition during V_{CC} on/off may cause the trigger for the unintentional programming.
- V_{CC} should be turned off after the EEPROM is placed in a standby state.
- V_{CC} turn on speed (tr) should be longer than 10 us (tr > 10 μ s).

Write/Erase Endurance and Data Retention Time

The endurance is 10^5 cycles in case of page programming and 10^4 cycles in case of byte programming (1% cumulative failure rate). The data retention time is more than 10 years when a device is page-programmed less than 10^4 cycles.

Noise Suppression Time

This EEPROM have a noise suppression function at SCL and SDA inputs, that cut noise of width less than 50 ns. Be careful not to allow noise of width more than 50 ns.

Package Dimensions

HN58X24512FPI (FP-8DF)

Preliminary

As of January, 2002

Unit: mm

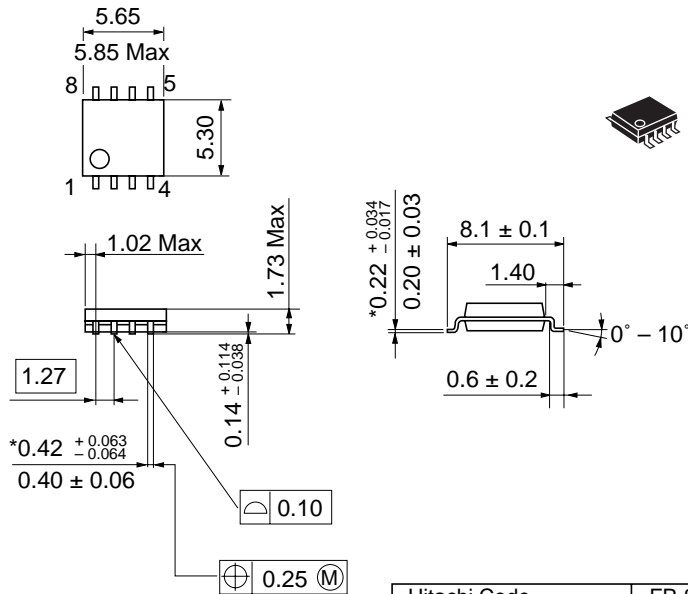

*Dimension including the plating thickness
Base material dimension

Hitachi Code	FP-8DF
JEDEC	—
JEITA	—
Mass (reference value)	0.153 g

Cautions

1. Hitachi neither warrants nor grants licenses of any rights of Hitachi's or any third party's patent, copyright, trademark, or other intellectual property rights for information contained in this document. Hitachi bears no responsibility for problems that may arise with third party's rights, including intellectual property rights, in connection with use of the information contained in this document.
2. Products and product specifications may be subject to change without notice. Confirm that you have received the latest product standards or specifications before final design, purchase or use.
3. Hitachi makes every attempt to ensure that its products are of high quality and reliability. However, contact Hitachi's sales office before using the product in an application that demands especially high quality and reliability or where its failure or malfunction may directly threaten human life or cause risk of bodily injury, such as aerospace, aeronautics, nuclear power, combustion control, transportation, traffic, safety equipment or medical equipment for life support.
4. Design your application so that the product is used within the ranges guaranteed by Hitachi particularly for maximum rating, operating supply voltage range, heat radiation characteristics, installation conditions and other characteristics. Hitachi bears no responsibility for failure or damage when used beyond the guaranteed ranges. Even within the guaranteed ranges, consider normally foreseeable failure rates or failure modes in semiconductor devices and employ systemic measures such as fail-safes, so that the equipment incorporating Hitachi product does not cause bodily injury, fire or other consequential damage due to operation of the Hitachi product.
5. This product is not designed to be radiation resistant.
6. No one is permitted to reproduce or duplicate, in any form, the whole or part of this document without written approval from Hitachi.
7. Contact Hitachi's sales office for any questions regarding this document or Hitachi semiconductor products.

HITACHI**Hitachi, Ltd.**

Semiconductor & Integrated Circuits
Nippon Bldg., 2-6-2, Ohte-machi, Chiyoda-ku, Tokyo 100-0004, Japan
Tel: (03) 3270-2111 Fax: (03) 3270-5109

URL <http://www.hitachisemiconductor.com/>

For further information write to:

Hitachi Semiconductor
(America) Inc.
179 East Tasman Drive
San Jose, CA 95134
Tel: <1> (408) 433-1990
Fax: <1> (408) 433-0223

Hitachi Europe Ltd.
Electronic Components Group
Whitebrook Park
Lower Cookham Road
Maidenhead
Berkshire SL6 8YA, United Kingdom
Tel: <44> (1628) 585000
Fax: <44> (1628) 585200

Hitachi Europe GmbH
Electronic Components Group
Dornacher Strasse 3
D-85622 Feldkirchen
Postfach 201, D-85619 Feldkirchen
Germany
Tel: <49> (89) 9 9180-0
Fax: <49> (89) 9 29 30 00

Hitachi Asia Ltd.
Hitachi Tower
16 Collyer Quay #20-00
Singapore 049318
Tel : <65>-6538-6533/6538-8577
Fax : <65>-6538-6933/6538-3877
URL : <http://semiconductor.hitachi.com.sg>

Hitachi Asia Ltd.
(Taipei Branch Office)
4/F, No. 167, Tun Hwa North Road
Hung-Kuo Building
Taipei (105), Taiwan
Tel : <886>-(2)-2718-3666
Fax : <886>-(2)-2718-8180
Telex : 23222 HAS-TP
URL : <http://www.hitachi.com.tw>

Hitachi Asia (Hong Kong) Ltd.
Group III (Electronic Components)
7/F., North Tower
World Finance Centre,
Harbour City, Canton Road
Tsim Sha Tsui, Kowloon Hong Kong
Tel : <852>-2735-9218
Fax : <852>-2730-0281
URL : <http://semiconductor.hitachi.com.hk>

Copyright©Hitachi, Ltd., 2002. All rights reserved. Printed in Japan.

Colophon 6.0