



RF / Microwave Components

Attenuators

Adapters

Bias Tees

Couplers

DC Blocks

Gain Equalizers

Power Dividers

Terminations



Short Form Catalog

Table of Contents

Company Profile	1	
Attenuators	2-8	
Impedance Matching Pads	5	<i>Catalog Notes</i>
iCALIBER Test Cables	8	<i>The 2.9mm products shown herein are in fact 2.92mm components. Aeroflex / Inmet has elected to use 2.9mm as a "shorthand" designation for the 2.92mm standard.</i>
Terminations	9-12	
Adapters	13-17	
DC Blocks	18-19	
Bias Tees	20	<i>Components with SMP connectors will also mate with GPO™ products; and the SMPM products mate with GPPO™ components.</i>
Equalizers	21	
Power Dividers	22	
Directional Couplers, Opens, Shorts, Detectors, Dust Caps	23	<i>The trademarks "GPO™" and "GPPO™" appearing in this catalog are trademarks of Corning Gilbert Inc.</i>
How to Order	24	
Distribution.....	Inside Back Cover	

How to use this catalog

This catalog is designed to give you a general description of the broad selection of products manufactured by Aeroflex / Inmet. When used in conjunction with our web site, you can view, print, or download detailed data sheets for each product in PDF format. Each sheet contains an outline drawing, electrical and mechanical specifications, as well as part number examples. It's easy:

1. Simply log on to www.aeroflex.com/inmet.
2. Select the first item "INMET MODEL SEARCH" in the drop-down menu box at left.
3. Enter the Model Number of the Product you wish to see, and touch enter.
4. In the results box that appears, click on the link under the "Product Page" heading, and you will be directed to web page for the selected item.
5. From here you can download a Product Data Sheet for the selected item, or you may request a quote by clicking on the "Quote" button next to the model number.

RoHS Statement

All standard catalog products designed by Aeroflex / Inmet shipped after July 1, 2006 conform to the requirements as specified in the Directive 2002/95/EC of the European Parliament and of the Council of 27 January 2003 and related Annex and Amendments on the Restriction of the Use of Certain Hazardous Substances in Electrical and Electronic Equipment (RoHS). The information presented herein is believed to be accurate, reliable and is a result of review of numerous sources including vendor submitted data sheets and certifications.

Please note:

1. Equalizers are not considered standard catalog products for the purpose of this statement.
2. Some equalizer products may already be RoHS compliant. Please direct any questions to inmet-sales@aeroflex.com

A Word About Aeroflex / Inmet



Manufacturer and designer of wireless and microwave components, Aeroflex / Inmet's custom design capabilities have generated a substantial number of innovative microwave and wireless components for many markets and programs for more than 30 years.

As product development is a core value, Aeroflex / Inmet will continue to demonstrate its talent for tackling new design tasks. Unusual customer specifications which require Inmet engineering to build custom components enable Inmet to stay ahead in wireless technology by designing, creating, testing and delivering products to be used in 2G, 3G, 4G systems and beyond.

Enthusiastic reaction to Aeroflex / Inmet's total commitment to quality, selection, and just-in-time delivery of precision-made microwave and wireless components has resulted in Inmet's "preferred supplier" designation by many buyers. With notable success in advancing new products, the company's widely known lineup of off-the-shelf products is relied upon by its many customers.

Coaxial components in the DC to 65 GHz frequency range with power levels from 1 to 300 Watts, enhance Inmet's vision to become the world's number one source for coaxial attenuators. The company offers over 3,000 variations of coaxial products including:

- Coaxial Attenuators (1-300 Watt, DC-50 GHz)
- Adapters (In-series and Between Series, DC-65 GHz)
- DC Blocks (Inner, Outer, Inner/Outer Designs up to 40 GHz)
- Equalizers (High Performance, DC-40 GHz)
- Short and Open Circuits (DC-18 GHz)
- Terminations (1-300 Watts, DC-50 GHz)
- Power Dividers, (DC-26.5 GHz)
- Bias Tees (General Purpose, High Power, Broadband)

Aeroflex / Inmet also designs and manufactures multi-component hybrid products such as "between series attenuators," combination "DC block/attenuators," and "by-pass attenuators." Today, Aeroflex / Inmet is a leader in reducing the costs of components while maintaining "first class performance." On demand inventory features hundreds of off-the-shelf catalog items ready for same-day shipment, or overnight delivery.

In addition, many products are available through Richardson Electronics, or RFMW, Aeroflex / Inmet's distributors. By increasing your efficiency and profitability through our total commitment to service, support, quality, delivery, low prices and innovation, Inmet ensures your success...which in turn becomes Aeroflex / Inmet's success as well.



Attenuator Reference Guide

Model A/AH SMA

SHORT: 0.86"
Nominal Length

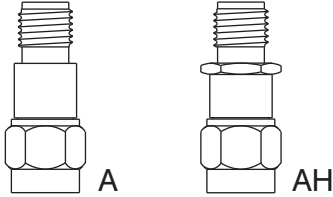

**Models 2A, 6A, 18A, 23A
2AH, 6AH, 18AH, 23AH**

Frequency Range..... DC to 23GHz
Available Values..... 0-10, 12, 15, 20, 30dB
Accuracy of Attenuation:
0 through 6dB.....±0.3dB maximum
7 through 20dB.....±0.5dB maximum
21 through 30dB.....±0.75dB maximum
VSWR:
DC to 4GHz.....1.15:1 maximum
4GHz to 8GHz.....1.20:1 maximum
8GHz to 12.4GHz.....1.25:1 maximum
12.4GHz to 18GHz.....1.35:1 maximum
18GHz to 23GHz.....1.40:1 maximum

Overall length in inches

	0-12dB	13-30dB
M/F	.86 ± .03	.99 ± .03
M/M	.98 ± .03	1.11 ± .03
F/F	.87 ± .03	1.00 ± .03

Complete Specification Sheet Available

Model C SMA

SHORTER: 0.76"
Nominal Length

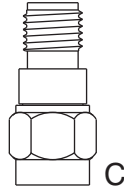

Models 2C, 6C, 18C

Frequency Range..... DC to 18GHz
Available Values..... 0-10, 12, 15, 20, 30dB
Accuracy of Attenuation:
0 through 6dB.....±0.3dB maximum
7 through 20dB.....±0.5dB maximum
21 through 30dB.....±0.75dB maximum
VSWR:
DC to 4GHz.....1.15:1 maximum
4GHz to 8GHz.....1.20:1 maximum
8GHz to 12.4GHz.....1.25:1 maximum
12.4GHz to 18GHz.....1.35:1 maximum

Overall length in inches

	0-12dB	13-30dB
M/F	.76 ± .03	.89 ± .03

Complete Specification Sheet Available

Model DH SMA

SHORTEST: 0.70"
Nominal Length



**Models 2DH, 6DH,
18DH, 23DH**

Frequency Range..... DC to 23GHz
Available Values.... 0-10, 12, 15, 20, 30, 40dB
Accuracy of Attenuation:
0 through 6dB.....±0.3dB maximum
7 through 20dB.....±0.5dB maximum
21 through 30dB.....±0.7dB maximum
31 through 35dB.....±1.0dB maximum
36 through 40dB.....±1.5dB maximum
VSWR:
DC to 4GHz.....1.15:1 maximum
4GHz to 8GHz.....1.20:1 maximum
8GHz to 12.4GHz.....1.25:1 maximum
12.4GHz to 23GHz.....1.35:1 maximum

Overall length in inches

	0-20dB	21-40dB
M/F	.70 ± .03	.83 ± .03
M/M	.76 ± .03	.89 ± .03
F/F	.64 ± .03	.77 ± .03

Complete Specification Sheet Available

Model AHC SMA

0.86"
Nominal Length

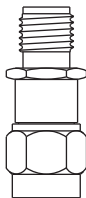

Model AHC

Frequency Range..... DC to 6 GHz
Available Values..... 0-10, 12, 15, 20, 30dB
Accuracy of Attenuation:
1 through 10dB.....±0.5dB maximum
12, 15, 20dB.....±0.7dB maximum
30dB.....±0.9dB maximum
VSWR:
DC to 6 GHz.....1.20:1 maximum

Overall length in inches

	0-12dB	15/20/30dB
M/F	.86 ± .02	.99 ± .02

Complete Specification Sheet Available

Model B SMA

1.21"
Nominal Length

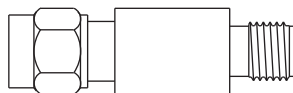

Models 2B, 6B, 18B

Frequency Range..... DC to 18GHz
Available Values..0-10, 12, 15, 20, 30, 40, 50, 60dB
Accuracy of Attenuation:
0 through 6dB.....±0.3dB maximum
7 through 20dB.....±0.5dB maximum
21 through 30dB.....±0.75dB maximum
31 through 60dB.....±1.50dB maximum
VSWR:
DC to 4GHz.....1.15:1 maximum
4GHz to 8GHz.....1.20:1 maximum
8GHz to 12.4GHz.....1.25:1 maximum
12.4GHz to 18GHz.....1.35:1 maximum

Overall length in inches

	0-30 & 40dB	31-60dB
M/F	1.21 ± .03	1.49 ± .03
M/M	1.33 ± .03	1.62 ± .03
F/F	1.06 ± .03	1.35 ± .03

Complete Specification Sheet Available

9000 Series General Purpose 18GHz SMA Attenuators

Models 9023, 9024, 9025

Available Values 0-10, 12, 15, 20, 30, 40, 50, 60dB
Accuracy of Attenuation:
0 through 12dB.....±0.75dB maximum
13 through 20dB.....±1.00dB maximum
21 through 40dB.....±1.50dB maximum
41 through 60dB.....±2.00dB maximum

Models 9026 through 9031

Available Values..... 0-10, 12, 15, 20, 30dB
Accuracy of Attenuation:
0 through 12dB.....±0.75dB maximum
13 through 20dB.....±1.00dB maximum
21 through 30dB.....±1.50dB maximum
VSWR: (All Models)
DC to 4GHz.....1.20:1 maximum
4GHz to 12.4GHz.....1.40:1 maximum
12.4GHz to 18GHz.....1.60:1 maximum

Overall length in inches

		0-30&40dB	31-60dB <small>(except 40)</small>
9023	M/F no hex	1.21±.03	1.49±.03
9024	M/M no hex	1.33±.03	1.62±.03
9025	F/F no hex	1.06±.03	1.35±.03
		0-12 dB	13-30dB
9026	M/F no hex	.86±.03	.99±.03
9027	M/M no hex	.98±.03	1.11±.03
9028	F/F no hex	.87±.03	1.00±.03
9029	M/F w/hex	.86±.03	.99±.03
9030	M/M w/hex	.98±.03	1.11±.03
9031	F/F w/hex	.87±.03	1.00±.03

Complete Specification Sheets Available

Attenuator Reference Guide



SMP, GPO™ Series

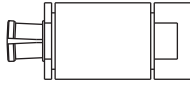

Models 18G, 18P
 Frequency Range.....DC to 18GHz
 Available Values.....0-13, 20 and 30dB
 Accuracy of Attenuation:
 1 through 6dB.....±0.4dB maximum
 7 through 12dB.....±0.6dB maximum
 20 and 30dB.....±0.8dB maximum
 VSWR:
 DC to 8GHz.....1.25:1 maximum
 8GHz to 18GHz.....1.35:1 maximum

Models 26G, 26P
 Frequency Range.....DC to 26GHz
 Available Values.....0-4, 6, 10, 20 and 30dB
 Accuracy of Attenuation:
 DC-26.5GHz
 0-4 and 6dB.....±0.6dB
 10dB.....±0.8dB
 20 and 30dB.....±1.2dB
 VSWR:
 DC to 26.5GHz.....1.45:1 maximum

Note: GPO™ and SMP male connectors are available in full and limited detent.

Complete Specification Sheet Available

High Frequency 2.9mm Series DC-26.5 GHz and DC-40 GHz

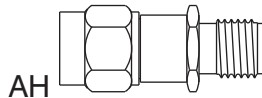
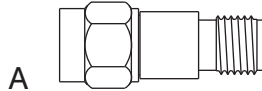

MODELS 26A AND 26AH (2 Watts)
 Frequency Range.....DC to 26.5GHz
 Available Values.....0, 3, 6, 10, 20, 30dB
 VSWR:
 DC to 18GHz.....1.30:1 maximum
 18GHz to 26.5GHz.....1.40:1 maximum

MODELS 40A, 40AH (0.5 Watt)
 Frequency Range.....DC to 40GHz
 Available Values.....0, 3, 6, 10, 20, 30dB
 VSWR:
 DC to 40GHz.....1.40:1 maximum

Overall length in inches

	0-12dB	13-30dB
26.5GHz		
M/F	.88 ± .05	1.01 ± .05
40GHz	0-30dB	
M/F	.88 ± .05	

Complete Specification Sheet Available

High Frequency 2.4mm & 1.85mm Series DC-40 GHz and DC-50 GHz



Models 40EH and 50EH
 Frequency Range.....DC to 50GHz
 Available Values.....0, 3, 6, 10, 20, 30dB
 Accuracy of Attenuation:
 DC - 26.5 GHz
 0 through 10dB.....±0.5dB maximum
 20 & 30dB.....±0.75dB maximum
 26.5 - 40 GHz
 0 through 10dB.....±1.0dB maximum
 20 & 30dB.....±1.25dB maximum
 40 - 50 GHz
 0 through 10dB.....±1.5dB maximum
 20 & 30dB.....±2.0dB maximum
 VSWR:
 DC to 26.5 GHz.....1.35:1 maximum
 26.5 to 40 GHz.....1.60:1 maximum
 40 to 50 GHz.....1.75:1 maximum

Models 50V
 Frequency Range.....DC to 50GHz
 Available Values.....3, 6, 10dB

Complete Specification Sheet Available

N Series (50 and 75 Ohms)

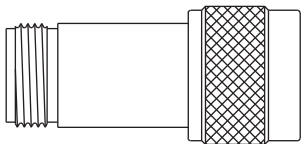

**50 Ohms
Nickel Plated Brass
Models 9070**
 Frequency Range.....DC to 6GHz
 Available Values.....0-10, 12, 15, 20, 30, and 40 dB
 VSWR:
 DC to 2GHz.....1.25:1 maximum

Stainless Steel Models 2N, 6N, 18N
 Frequency Range.....DC to 18GHz
 Available Values.....0-10, 12, 15, 20, 30, 40, 50 and 60dB
 VSWR:
 DC to 4GHz.....1.15:1 maximum
 4GHz to 8GHz.....1.20:1 maximum
 8GHz to 12.4GHz.....1.25:1 maximum
 12.4GHz to 18GHz.....1.35:1 maximum

**75 Ohms
Model 4N-XX/75**
 Frequency Range.....DC to 4GHz
 Available Values.....1, 2, 3, 6, 10, 20 and 30dB
 VSWR.....1.30:1 maximum

Complete Specification Sheet Available

TNC Series

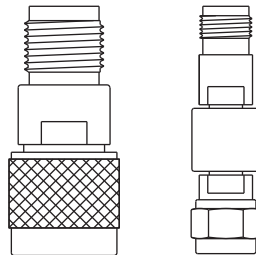

Model 9042 & 9036 (Nickel Plated Brass)
 Frequency Range.....DC to 12.4GHz
 Available Values...0-10, 12, 15, 20, 30 & 40dB
Models 18T (Stainless Steel)
 Frequency Range.....DC to 18GHz
 Available Values 0-10, 12, 15, 20, 30, 40, 50, 60dB
 Accuracy of Attenuation:
 0 through 6dB.....±0.3dB maximum
 7 through 20dB.....±0.5dB maximum
 30dB.....±0.75dB maximum
 40dB.....±1.0dB maximum
 50 & 60dB.....±1.50dB maximum*
 VSWR:
 DC to 4GHz.....1.15:1 maximum
 4GHz to 8GHz.....1.20:1 maximum
 8GHz to 12.4GHz.....1.25:1 maximum
 12.4GHz to 18GHz.....1.35:1 maximum*

*18T only

Complete Specification Sheet Available

BNC Series (50 and 75 Ohms)

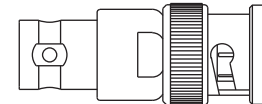

(2 Watts)

**50 Ohms
Model 9033**
 Frequency Range.....DC to 4 GHz
 Available Values.....0-10, 12, 15, 20, 30dB
 VSWR:
 DC to 4GHz.....1.25:1 maximum
Model 9014
 Frequency Range.....DC to 4 GHz
 Available Values.....40, 50 & 60 dB
 VSWR:
 DC to 4 GHz.....1.25:1 maximum
Model 2051
 Frequency Range.....DC to 12.4 GHz
 Available Values.....3, 6, 10, 20 & 30dB
 VSWR:
 DC to 4GHz.....1.25:1 maximum
 4GHz to 8GHz.....1.30:1 maximum
 8GHz to 12.4GHz.....1.35:1 maximum

**75 Ohms
Model 9033-XX/75**
 Frequency Range.....DC to 4GHz
 Available Values.....0, 3, 6, 10, 20 & 30dB
 VSWR:
 DC to 1GHz.....1.10:1 maximum
 1GHz to 2GHz.....1.20:1 maximum
 2GHz to 4GHz.....1.35:1 maximum

Complete Specification Sheet Available

Attenuator Reference Guide

Attenuators—Power Handling vs. Frequency vs. Connector Type

GHz ▶	DC-1.5	DC-2.5	DC-4	DC-6	DC-7.5	DC-12.4	DC-18	DC-23	DC-26.5	DC-40	DC-50
F 75Ω	2W	2W									
7/16	300W	300W	300W	100W	50W						
BNC	100W	100W	100W								
N	300W	300W	300W	100W	50W	50W	50W				
TNC	300W	300W	300W	100W	50W	50W	50W				
SMA	300W	300W	300W	100W	50W	50W	50W	2W			
SMB	2W	2W	2W								
2.9mm	2W	2W	2W	2W	2W	2W	2W	2W	2W	2W	
GP0/SMP™	2W	2W	2W	2W	2W	2W	2W	2W	2W		
2.4mm	.5W	.5W	.5W	.5W	.5W	.5W	.5W	.5W	.5W	.5W	.5W
1.85mm	2W	2W	2W	2W	2W	2W	2W	2W	2W	2W	2W

Power handling capabilities shown are MAXIMUM for the respective frequencies and connector types. Contact factory for specific lower power vs. frequency applications.

MODEL NO.	FREQ. (GHz)	CONNECTOR	VSWR	ATTN (dB)
1 Watt Ultra Low Cost Attenuators				
AS398	3	SMA-M/F	1.20:1	1-10,12,15,20,30
2 Watt Low Cost Attenuators				
AHC	6	SMA-M/F	1.20:1	1-10,12,15,20,30
9026, (Style A)	18	SMA-M/F	1.60:1	0-10,12,15,20,30
9029, (Style AH)	18	SMA-M/F	1.60:1	0-10,12,15,20,30
9023, (Style B)	18	SMA-M/F	1.60:1	0-10,12,15,20,30,40,50,60
9070	6	N-M/F	1.25:1	1-10,12,15,20,30,40
.5 Watt and 2 Watt Attenuators, SMA, General Purpose, 2.9mm, 2.4mm*				
2A, 2AH	2.5	SMA-M/F, M/M, F/F	1.15:1	0-10,12,15,20,30,40
2B	2.5	SMA-M/F, M/M, F/F	1.15:1	0-10,12,15,20,30,40,50,60
2C	2.5	SMA-M/F	1.15:1	0-10,12,15,20,30
2DH	2.5	SMA-M/F, M/M, F/F	1.15:1	0-10,12,15,20,30,40
6A, 6AH	6	SMA-M/F, M/M, F/F	1.20:1	0-10,12,15,20,30,40
6B	6	SMA-M/F, M/M, F/F	1.20:1	0-10,12,15,20,30,40,50,60
6C	6	SMA-M/F	1.20:1	0-10,12,15,20,30
6DH	6	SMA-M/F, M/M, F/F	1.20:1	0-10,12,15,20,30,40
18A, 18AH	18	SMA-M/F, M/M, F/F	1.35:1	0-10,12,15,20,30,40
18B	18	SMA-M/F, M/M, F/F	1.35:1	0-10,12,15,20,30,40,50,60
18C	18	SMA-M/F	1.35:1	0-10,12,15,20,30
18DH	18	SMA-M/F, M/M, F/F	1.35:1	0-10,12,15,20,30,40
23A, 23AH	23	SMA-M/F, M/M, F/F	1.40:1	0-10,12,15,20,30
23DH	23	SMA-M/F, M/M, F/F	1.35:1	0-10,12,15,20,30
26A, 26AH	26.5	2.9mm-M/F	1.40:1	0,3,6,10,20,30
40A, 40AH (0.5W)	40	2.9mm-M/F	1.40:1	0,3,6,10,20,30
40A2W, 40AH2W	40	2.9mm-M/F	1.40:1	3,6,10,20,30
40EH (0.5W)	40	2.4mm-M/F	1.60:1	0,3,6,10,20,30
50EH (0.5W)	50	2.4mm-M/F	1.75:1	0,3,6,10,20,30
50V	50	1.85mm-M/F	1.75:1	3,6,10

* See pages 2 and 3 for more detailed specifications.

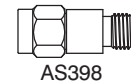

AS398

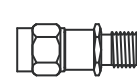

Model AHC

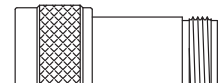

9070-M/F

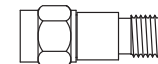

SMA-M/F, A

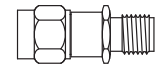

SMA-M/F, AH

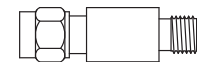

SMA-M/F, B

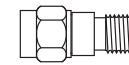

SMA-M/F, C

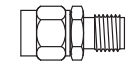

SMA-M/F, DH

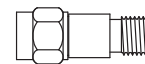

2.9mm-M/F, A

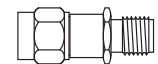

2.9mm-M/F, AH

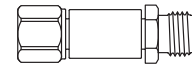

2.4mm-M/F, EH

Attenuator Reference Guide

MODEL NO.	FREQ. (GHz)	CONNECTOR	VSWR	ATTN (dB)
2 Watt Attenuators, N, BNC, SMB, TNC, GPO™, SMP, SMPM				
2N	2.5	N-M/F, M/M, F/F	1.15:1	0-10,12,15,20,30,40,50,60
6N	6	N-M/F, M/M, F/F	1.20:1	0-10,12,15,20,30,40,50,60
18N	18	N-M/F, M/M, F/F	1.35:1	0-10,12,15,20,30,40,50,60
9033	4	BNC-M/F	1.25:1	0-10,12,15,20,30
9014	4	BNC-M/F	1.25:1	40,50,60
2051	12.4	BNC-M/F	1.35:1	3,6,10,20,30
9056	4	SMB-M/F, M/M, F/F	1.20:1	0-10,12,15,20,30
9042	2.5	TNC-M/F	1.25:1	0-10,12,15,20,30,40
9036	12.4	TNC-M/F	1.25:1	0-10,12,15,20,30,40
18T	18	TNC-M/F, M/M, F/F	1.35:1	0-10,12,15,20,30,40,50,60
18G	18	GPO-M/F, M/M, F/F	1.35:1	0-13,20,30
26G	26.5	GPO-M/F, M/M, F/F	1.45:1	0-4,6,10,20,30
18P	18	SMP-M/F, M/M, F/F	1.35:1	0-13,20,30
26P	26.5	SMP-M/F, M/M, F/F	1.45:1	0-4,6,10,20,30
6MP	6	SMPM-M/F, M/M, F/F	1.35:1	13,20,30

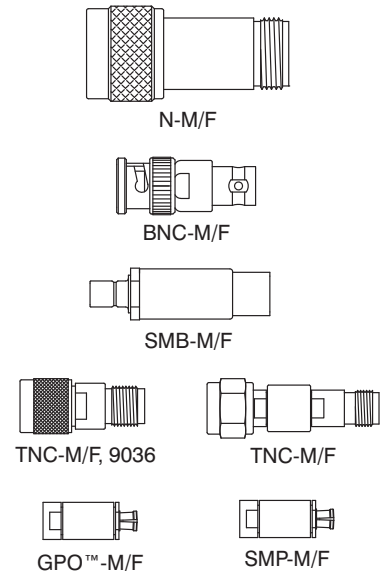

Note: GPO™ and SMP male connectors are available in full and limited detent.

2 Watt 75 Ohm Attenuators

3F	3	F-M/F, M/M, F/F	1.15:1	3,6,10,15,20,30
9033-XX/75	4	BNC-M/F	1.35:1	0,3,6,10,20,30

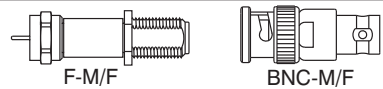

1 Watt Impedance Matching Pads (50 to 75 Ohm)

9033-50/75	1	BNC-M/F	1.20:1	5.7
9033-75/50	1	BNC-M/F	1.20:1	5.7
9070-50/75	3	N-M/F	1.35:1	5.7
9070-75/50	3	N-M/F	1.35:1	5.7
9076-50/75	3	SMA-M/F-F	1.25:1	5.7
9077-50/75	3	N-M/F-F	1.25:1	5.7
9078-50/75	3	BNC-M/F-F	1.25:1	5.7
9079-50/75	3	SMA-F/F-M	1.25:1	5.7
9080-50/75	3	SMA-M/F-M	1.25:1	5.7
9082-50/75	3	N-F/F-M	1.25:1	5.7
9083-50/75	3	N-M/F-M	1.25:1	5.7
9084-50/75	3	TNC-F/F-M	1.25:1	5.7
9085-50/75	3	TNC-M/F-M	1.25:1	5.7
9086-50/75	3	BNC-F/F-M	1.25:1	5.7
9087-50/75	3	BNC-M/F-M	1.25:1	5.7
9088-50/75	3	SMA-F/F-F	1.25:1	5.7
9089-50/75	3	N-F/F-F	1.25:1	5.7
9090-50/75	3	BNC-F/F-F	1.25:1	5.7
9091-50/75	3	TNC-M/F-F	1.25:1	5.7
9092-50/75	3	TNC-F/F-F	1.25:1	5.7

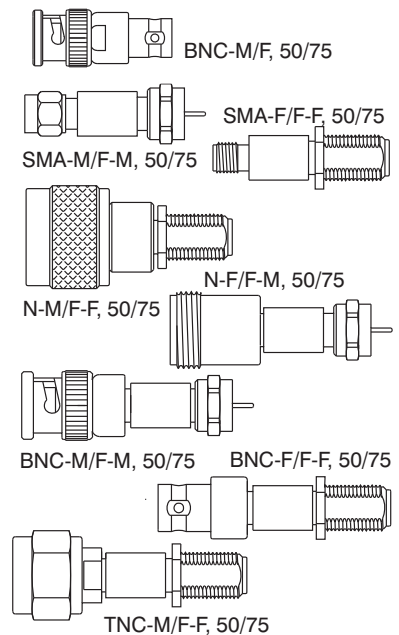

2 Watt DC Bias Passing RF Attenuators

9093-N	0.50-2	N-M/F	1.35:1	4,6,10,15,20,25
9093-SMA	0.50-2	SMA-M/F	1.35:1	4,6,10,15,20,25
9093-TNC	0.50-2	TNC-M/F	1.35:1	4,6,10,15,20,25
9093-F	0.50-2	F-M/F	75Ω	1.45:1 3,4,6,7,8,9,10,11,20
9095-N	0.05-3	N-M/F	1.35:1	3,4,6,10,15,20,25
9095-SMA	0.05-3	SMA-M/F	1.35:1	3,4,6,10,15,20,25
9095-TNC	0.05-3	TNC-M/F	1.35:1	3,4,6,10,15,20,25

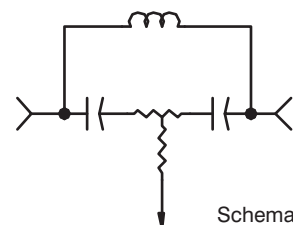

Schematic Diagram

Attenuator Reference Guide

MODEL NO. FREQ. (GHz) CONNECTOR VSWR ATTN (dB)

2 Watt DC Blocking Attenuators (Also See DC Block Section, page 19)

8516S-XX	0.01-2	SMA-M/F	1.15:1	0-10,12,15,20
----------	--------	---------	--------	---------------

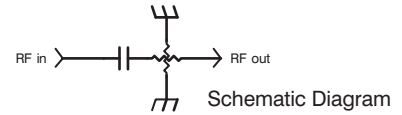

1 and 2 Watt Flange Mount Attenuators

2004	18	SMA-M/F	1.35:1	0-10,12,15,20,30
2086K	18	2.9mm-F/PIN 4 hole	1.50:1	0-12
2087K	18	2.9mm-M/PIN 4 hole	1.50:1	0-12

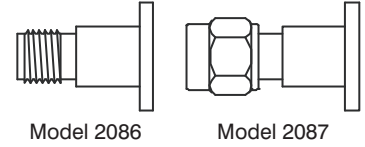

Adapting Attenuators, Between Series

2028	18	N/M-SMA/M	1.30:1	0-10,12,15,20
2029	18	N/M-SMA/F	1.30:1	0-10,12,15,20
2030	18	N/F-SMA/M	1.30:1	0-10,12,15,20
2031	18	N/F-SMA/F	1.30:1	0-10,12,15,20

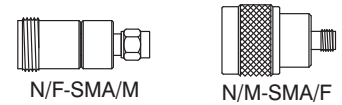

Calibrated Attenuator Sets

9401	18	N		3,6,10,20
9402	12.4	N		3,6,10,20
9403	18	SMA	(A Style)	3,6,10,20
9404	12.4	SMA	(A Style)	3,6,10,20
9405	18	N		1,3,6,10,20,30
9406	12.4	N		1,3,6,10,20,30
9407	18	SMA	(A Style)	1,3,6,10,20,30
9408	12.4	SMA	(A Style)	1,3,6,10,20,30
9477	23	SMA	(AH Style)	1,3,6,10,20,30
9473	23	SMA	(DH Style)	1,3,6,10,20,30
9411	26.5	2.9mm	(A Style)	3,6,10,20
9412	26.5	2.9mm	(A Style)	1,3,6,10,20,30
9413	(0.5W)	40	2.9mm (A Style)	3,6,10,20
9414	(0.5W)	40	2.9mm (A Style)	1,3,6,10,20,30
9415	(0.5W)	40	2.4mm (EH Style)	3,6,10,20
9416	(0.5W)	50	2.4mm (EH Style)	3,6,10,20

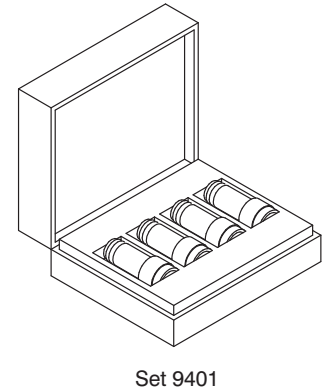

5 Watt Attenuators, Convection Cooled

6B5W	6	SMA-M/F, M/M, F/F	1.20:1	0-12,15,20,30,40
18B5W	18	SMA-M/F, M/M, F/F	1.35:1	0-10,12,15,20,30,40
6N5W	6	N-M/F, M/M, F/F	1.20:1	0-12,15,20,30,40
18N5W	18	N-M/F, M/M, F/F	1.35:1	0-10,12,15,20,30,40
2D5W	2.5	7/16 DIN-M/F, M/M, F/F	1.25:1	0-12,15,20,30,40
7D5W	7.5	7/16 DIN-M/F, M/M, F/F	1.45:1	0-12,15,20,30,40
4BNC5W	4	BNC-M/F, M/M, F/F	1.25:1	0-12,15,20,30,40
6T5W	6	TNC-M/F, M/M, F/F	1.20:1	0-12,15,20,30,40
18T5W	18	TNC-M/F, M/M, F/F	1.35:1	0-10,12,15,20,30,40

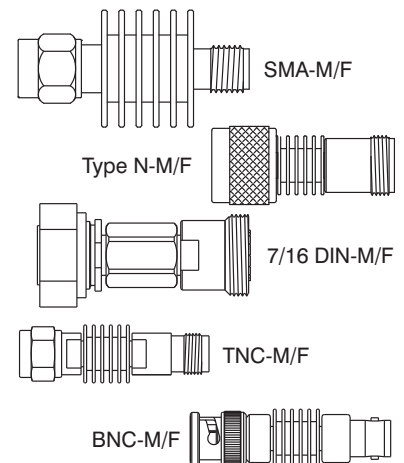

Attenuator Reference Guide



MODEL NO. FREQ. (GHz) CONNECTOR VSWR ATTN (dB)

10 Watt Attenuators, Convection Cooled

6B10W	6	SMA-M/F, M/M, F/F	1.20:1	0-10,12,20,30,40
18B10W	18	SMA-M/F, M/M, F/F	1.40:1	0-10,12,20,30,40
6N10W	6	N-M/F, M/M, F/F	1.20:1	0-10,12,20,30,40
18N10W	18	N-M/F, M/M, F/F	1.40:1	0-10,12,20,30,40
2D10W	2.5	7/16 DIN, M/F, M/M, F/F	1.25:1	0-10,12,20,30,40
7D10W	7.5	7/16 DIN-M/F, M/M, F/F	1.45:1	0-10,12,20,30,40
4BNC10W	4	BNC-M/F, M/M, F/F	1.25:1	0-10,12,15,20,30
6T10W	6	TNC-M/F, M/M, F/F	1.20:1	0-10,12,20,30,40
18T10W	18	TNC-M/F, M/M, F/F	1.40:1	0-10,12,20,30,40

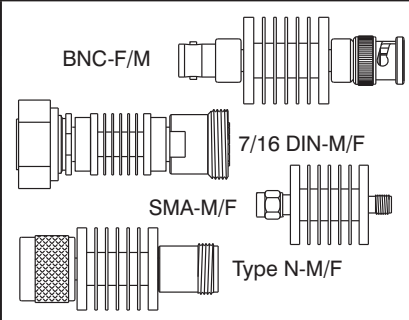

20 Watt Attenuators, Convection Cooled

6B20W	6	SMA-M/F, M/M, F/F	1.20:1	0,3,6,10,20,30,40
18B20W	18	SMA-M/F, M/M, F/F	1.40:1	0,3,6,10,20,30,40
2099 w/mounting holes	18	SMA-M/F, M/M, F/F	1.40:1	0,3,6,10,20,30,40
6N20W	6	N-M/F, M/M, F/F	1.20:1	0,3,6,10,20,30,40
2100 w/mounting holes	18	N-M/F, M/M, F/F	1.40:1	0,3,6,10,20,30,40
18N20W	18	N-M/F, M/M, F/F	1.40:1	0,3,6,10,20,30,40
2D20W	2.5	7/16 DIN-M/F, M/M, F/F	1.25:1	0,3,6,10,20,30,40
7D20W	7.5	7/16 DIN-M/F, M/M, F/F	1.45:1	0,3,6,10,20,30,40
4BNC20W	4	BNC-M/F, M/M, F/F	1.25:1	0,3,6,10,20,30,40
6T20W	6	TNC-M/F, M/M, F/F	1.20:1	0,3,6,10,20,30,40
18T20W	18	TNC-M/F, M/M, F/F	1.40:1	0,3,6,10,20,30,40

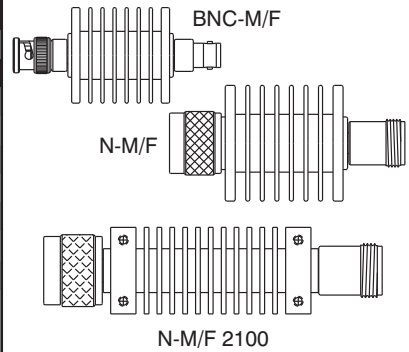

25 Watt Attenuators, Convection Cooled

6B25W	6	SMA-M/F, M/M, F/F	1.20:1	0,3,6,10,20,30,40
18B25W	18	SMA-M/F, M/M, F/F	1.40:1	0,3,6,10,20,30,40
6N25W	6	N-M/F, M/M, F/F	1.20:1	0,3,6,10,20,30,40
18N25W	18	N-M/F, M/M, F/F	1.40:1	0,3,6,10,20,30,40
2D25W	2.5	7/16 DIN-M/F, M/M, F/F	1.25:1	0,3,6,10,20,30,40
7D25W	7.5	7/16 DIN-M/F, M/M, F/F	1.45:1	0,3,6,10,20,30,40
2BNC25W	2.5	BNC-M/F, M/M, F/F	1.25:1	0,3,6,10,20,30,40
4BNC25W	4	BNC-M/F, M/M, F/F	1.25:1	0,3,6,10,20,30,40
6T25W	6	TNC-M/F, M/M, F/F	1.20:1	0,3,6,10,20,30,40
18T25W	18	TNC-M/F, M/M, F/F	1.40:1	0,3,6,10,20,30,40

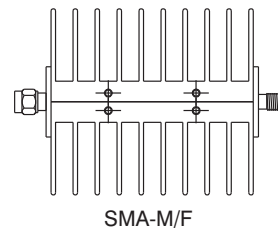

50 Watt Attenuators, Convection Cooled

6B50W	6	SMA-M/F, M/M, F/F	1.25:1	0,3,6,10,20,30,40
18B50W	18	SMA-M/F, M/M, F/F	1.45:1	0,3,6,10,20,30,40
6N50W	6	N-M/F, M/M, F/F	1.25:1	0,3,6,10,20,30,40
18N50W	18	N-M/F, M/M, F/F	1.45:1	0,3,6,10,20,30,40
2D50W	2.5	7/16 DIN-M/F, M/M, F/F	1.25:1	0,3,6,10,20,30,40
7D50W	7.5	7/16 DIN-M/F, M/M, F/F	1.45:1	0,3,6,10,20,30,40
4BNC50W	4	BNC-M/F, M/M, F/F	1.25:1	0,3,6,10,20,30,40
6T50W	6	TNC-M/F, M/M, F/F	1.25:1	0,3,6,10,20,30,40
18T50W	18	TNC-M/F, M/M, F/F	1.45:1	0,3,6,10,20,30,40

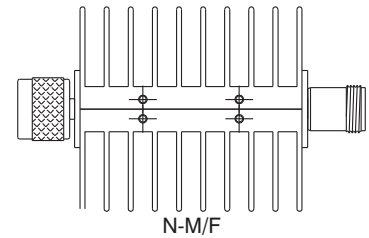

50 Watt Attenuators, Conduction Cooled

2042S	4	SMA-M/F, M/M, F/F	1.25:1	3,6,10,20,30,40
9037	18	SMA-M/F, M/M, F/F	1.45:1	3,6,10,20,30,40
2042	4	N-M/F, M/M, F/F	1.25:1	3,6,10,20,30,40
2042T	4	TNC-M/F, M/M, F/F	1.25:1	3,6,10,20,30,40

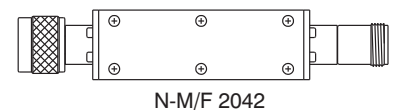

Attenuator Reference Guide

MODEL NO.	FREQ. (GHz)	CONNECTOR	VSWR	ATTN (dB)
100 Watt Attenuators, Convection Cooled				
2B100W	2.5	SMA-M/F, M/M, F/F	1.35:1	3,6,10,20,30,40
6B100W	6	SMA-M/F, M/M, F/F	1.45:1	3,6,10,20,30,40
2N100W	2.5	N-M/F, M/M, F/F	1.35:1	3,6,10,20,30,40
6N100W	6	N-M/F, M/M, F/F	1.45:1	3,6,10,20,30,40
2D100W	2.5	7/16 DIN-M/F, M/M, F/F	1.35:1	3,6,10,20,30,40
6D100W	6	7/16 DIN-M/F, M/M, F/F	1.45:1	3,6,10,20,30,40
2BNC100W	2.5	BNC-M/F, M/M, F/F	1.35:1	3,6,10,20,30,40
4BNC100W	4	BNC-M/F, M/M, F/F	1.45:1	3,6,10,20,30,40
2T100W	2.5	TNC-M/F, M/M, F/F	1.35:1	3,6,10,20,30,40
6T100W	6	TNC-M/F, M/M, F/F	1.45:1	3,6,10,20,30,40

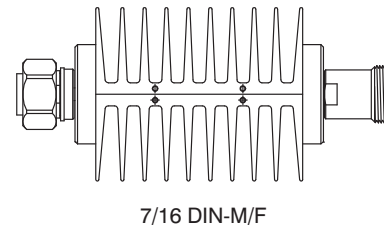

150 Watt Attenuators, Convection Cooled				
2B150W	2.5	SMA-M/F, M/M, F/F	1.25:1	3,6,10,20,30,40
4B150W	4	SMA-M/F, M/M, F/F	1.35:1	3,6,10,20,30,40
2N150W	2.5	N-M/F, M/M, F/F	1.25:1	3,6,10,20,30,40
4N150W	4	N-M/F, M/M, F/F	1.35:1	3,6,10,20,30,40
2D150W	2.5	7/16 DIN-M/F, M/M, F/F	1.30:1	3,6,10,20,30,40
4D150W	4	7/16 DIN-M/F, M/M, F/F	1.40:1	3,6,10,20,30,40
2T150W	2.5	TNC-M/F, M/M, F/F	1.25:1	3,6,10,20,30,40
4T150W	4	TNC-M/F, M/M, F/F	1.35:1	3,6,10,20,30,40

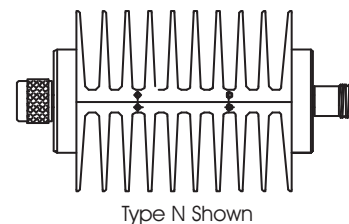

200 Watt Attenuators, Convection Cooled				
2B200W	2.5	SMA-M/F, M/M, F/F	1.25:1	3,6,10,20,30,40
4B200W	4	SMA-M/F, M/M, F/F	1.50:1	3,6,10,20,30,40
2N200W	2.5	N-M/F, M/M, F/F	1.25:1	3,6,10,20,30,40
4N200W	4	N-M/F, M/M, F/F	1.50:1	3,6,10,20,30,40
2D200W	2.5	7/16 DIN-M/F, M/M, F/F	1.25:1	3,6,10,20,30,40
4D200W	4	7/16 DIN-M/F, M/M, F/F	1.50:1	3,6,10,20,30,40
2T200W	2.5	TNC-M/F, M/M, F/F	1.25:1	3,6,10,20,30,40
4T200W	4	TNC-M/F, M/M, F/F	1.50:1	3,6,10,20,30,40

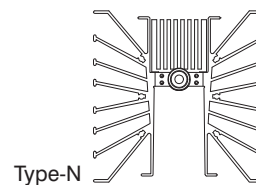

300 Watt Attenuators, Convection Cooled				
2B300W	2.5	SMA-M/F, M/M, F/F	1.25:1	3,6,10,20,30,40
4B300W	4	SMA-M/F, M/M, F/F	1.50:1	3,6,10,20,30,40
2N300W	2.5	N-M/F, M/M, F/F	1.25:1	3,6,10,20,30,40
4N300W	4	N-M/F, M/M, F/F	1.50:1	3,6,10,20,30,40
2D300W	2.5	7/16 DIN-M/F, M/M, F/F	1.25:1	3,6,10,20,30,40
4D300W	4	7/16 DIN-M/F, M/M, F/F	1.50:1	3,6,10,20,30,40
2T300W	2.5	TNC-M/F, M/M, F/F	1.25:1	3,6,10,20,30,40
4T300W	4	TNC-M/F, M/M, F/F	1.50:1	3,6,10,20,30,40

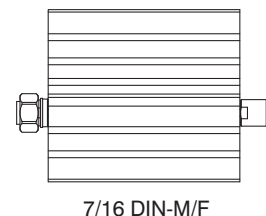

iCALIBER Test Cables

Model	Connector	Frequency	Body Style
iCALIBER Test Cables			
ICAL18-SM	SMA-M/M	DC - 18 GHz	
ICAL18-NM	N-M/M	DC - 18 GHz	Coming Soon
ICAL33-3.5mmM	3.5mm-M/M	DC - 33 GHz	Coming Soon

Termination Reference Guide

Terminations—Power Handling vs. Frequency vs. Connector Type

GHz ▶	DC-1	DC-2	DC-3	DC-4	DC-6	DC-7.5	DC-12.4	DC-18	DC-23	DC-26.5	DC-40	DC-50
F	2W	2W	2 W									
7/16	300W	300W	300W	300W	100W	100W						
BNC	50W	50W	50W	50W								
N	300W	300W	300W	300W	100W	50W	50W	50W				
TNC	300W	300W	300W	300W	100W	50W	50W	50W				
SMA	300W	300W	300W	300W	100W	50W	50W	50W	1W	1W		
SMB	2W	2W	2W	2W	2W							
2.9mm	.5W	.5W	.5W	.5W	.5W	.5W	.5W	.5W	.5W	.5W	.5W	
GPO ^W /SMP	1W	1W	1W	1W	1W	1W	1W	1W				
2.4mm	.5W	.5W	.5W	.5W	.5W	.5W	.5W	.5W	.5W	.5W	.5W	.5W

MODEL NO. FREQ. (GHz) CONNECTOR VSWR

1 and 2 Watt Ultra Low Cost Terminations

TS398M	(1W)	6	SMA-M	1.20:1
3202-NM		2.5	N-M	1.10:1
3206-NM		6	N-M	1.10:1
3204A-BNCM		4	BNC-M	1.35:1
3206-TNCM		6	TNC-M	1.30:1
3206-SMBS*		6	SMBS (Socket)	1.25:1

*See Closeouts on Web Site

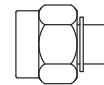

TS398

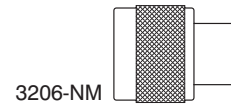

3206-NM

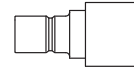

3206-SMBP



3206-SMBS

0.5 Watt and 1 Watt Terminations

TS060*		6	SMA-M, SMA-F	1.10:1
3016B*		18	SMA-M	1.30:1
TS180*		18	SMA-M, SMA-F	1.20:1
TS260*		26.5	SMA-M, SMA-F	1.25:1
3206-SMARP		6	SMA-M Reverse Polarity	1.20:1
3201-TNCRP		1	TNC-M, Reverse Polarity	1.25:1
TP180M	(1.0W)	18	SMP-M	1.20:1
TMP400	(0.5W)	40	SMPM-F	1.50:1
TMP500	(0.5W)	50	SMPM-F	2.00:1
TG180	(1.0W)	18	GPO-M, GPO-F	1.20:1
TS400*	(0.5W)	40	2.9mm-M, 2.9mm-F	1.20:1
TS400H*	(0.5W)	40	2.9mm-M, 2.9mm-F	1.20:1
TE400*	(0.5W)	40	2.4mm-M, 2.4mm-F	1.40:1
TE500*	(0.5W)	50	2.4mm-M, 2.4mm-F	1.60:1

*With chain, add suffix 'C' Note: G and P models are full detent, GL and PL models are limited detent

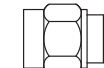

SMA-M

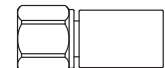

2.4mm-M

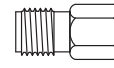

SMA-F

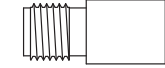

2.9mm-F

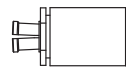

GPO™-F

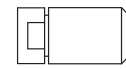

SMP-M

Note: GPO™ and SMP male connectors are available in full and limited detent.

Termination Reference Guide

MODEL NO. FREQ. (GHz) CONNECTOR VSWR

2 Watt Terminations

3029*	4	BNC-F	1.15:1
3038*	4	BNC-M	1.20:1
3030*	4	BNC-M	1.15:1
3004-067*	6	SMA-M, SMA-F	1.10:1
3004*	18	SMA-M, SMA-F	1.20:1
3070-067*	6	N-M, N-F	Brass 1.10:1
TN060*	6	N-M, N-F	1.15:1
TN180*	18	N-M, N-F	1.25:1
3018*	18	N-M, N-F	Brass 1.30:1
3070*	18	N-M, N-F	Brass 1.20:1
3101*, 3102*	18	N-M, N-F	1.06:1
TT060*	6	TNC-M, TNC-F	1.15:1
3069*	12.4	TNC-M, TNC-F	Brass 1.15:1
TT180*	18	TNC-M, TNC-F	1.25:1

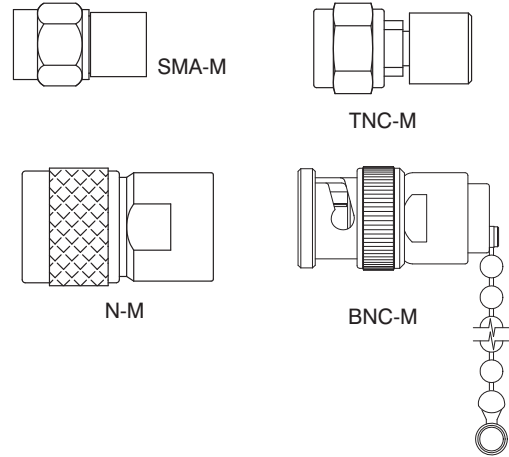

*With chain, add suffix "C"

75 Ohm 1 and 2 Watt Terminations

3038/75 (1W)	1	BNC-M	1.10:1
TF030M	3	F-M	1.20:1
TF030F	3	F-F	1.20:1
TN040/75	4	N-M, N-F	1.25:1

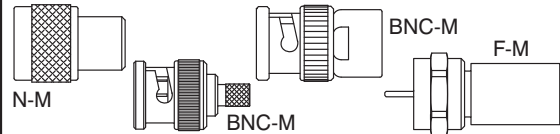

1 Watt DC Blocking Terminations (Also See DC Block Section, page 19)

8530S	30 kHz-18	SMA-M, SMA-F	INNER
8530N	30 kHz-18	N-M, N-F	INNER
8530PF	30 kHz-23	SMP-F	INNER
8541-MPF	100 kHz-50	SMPM-F	INNER

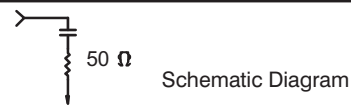

2 Watt Terminations, Feedthru

3032	0.5	BNC-M/F	1.25:1
3008, 3008H	1	SMA-M/F	1.25:1

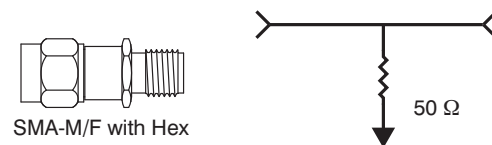

5 Watt Terminations

TS060-5W	6	SMA-M, SMA-F	1.15:1
3073	12.4	SMA-M, SMA-F	1.20:1
TS180-5W	18	SMA-M, SMA-F	1.25:1
TN060-5W	6	N-M, N-F	1.25:1
3073N	12.4	N-M, N-F	1.20:1
TN120-5W	12.4	N-M, N-F	1.20:1
TN180-5W	18	N-M, N-F	1.25:1
3018-5W	18	N-M	Brass 1.30:1
TD020-5W	2.5	7/16 DIN-M, 7/16 DIN-F	1.25:1
TD075-5W	7.5	7/16 DIN-M, 7/16 DIN-F	1.45:1
3073D	7.5	7/16 DIN-M, 7/16 DIN-F	1.45:1
TT060-5W	6	TNC-M, TNC-F	1.15:1
3073T	12.4	TNC-M, TNC-F	1.20:1
TT180-5W	18	TNC-M, TNC-F	1.25:1

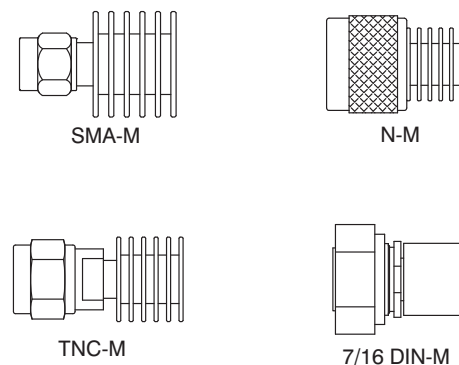

Termination Reference Guide

MODEL NO. FREQ. (GHz) CONNECTOR VSWR

10 Watt Terminations, Convection Cooled

TB040-10W	4	BNC-M, BNC-F	1.25:1
TS060-10W	6	SMA-M, SMA-F	1.20:1
TS180-10W	18	SMA-M, SMA-F	1.40:1
3074	12.4	SMA-M, SMA-F	1.20:1
3093	12.4	N-M, N-F	1.25:1
TN060-10W	6	N-M, N-F	1.25:1
TN180-10W	18	N-M, N-F	1.35:1
TD020-10W	2.5	7/16 DIN-M, 7/16 DIN-F	1.20:1
TD075-10W	7.5	7/16 DIN-M, 7/16 DIN-F	1.30:1
TT060-10W	6	TNC-M, TNC-F	1.20:1
TT180-10W	18	TNC-M, TNC-F	1.40:1

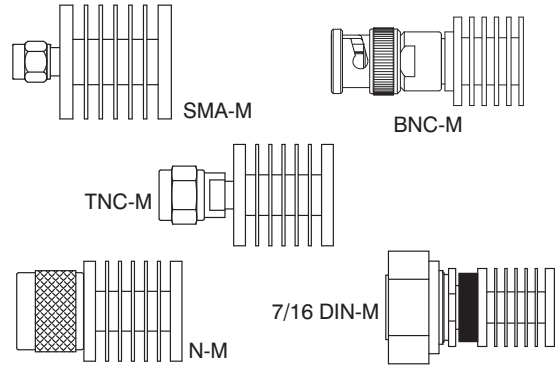

25 Watt Terminations, Convection Cooled

TS060-25W	6	SMA-M, SMA-F	1.20:1
TS180-25W	18	SMA-M, SMA-F	1.40:1
TN060-25W	6	N-M, N-F	1.20:1
TN180-25W	18	N-M, N-F	1.40:1
TD020-25W	2.5	7/16 DIN-M, 7/16 DIN-F	1.20:1
TD075-25W	7.5	7/16 DIN-M, 7/16 DIN-F	1.30:1
3112-XX	18	7/16 DIN, SMA, TNC, N	1.50:1
TT060-25W	6	TNC-M, TNC-F	1.20:1
TT180-25W	18	TNC-M, TNC-F	1.40:1

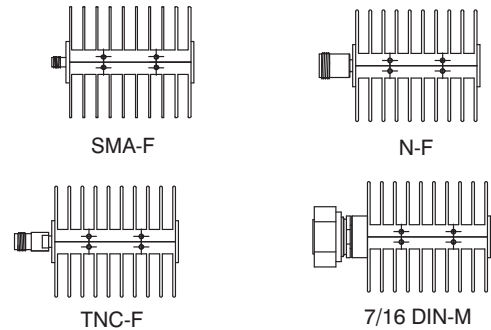

40 Watt Termination, Convection Cooled

3114S	12.4	SMA-M, SMA-F	1.35:1
-------	------	--------------	--------

50 Watt Terminations, Convection Cooled

TS060-50W	6	SMA-M, SMA-F	1.25:1
TS180-50W	18	SMA-M, SMA-F	1.45:1
TN060-50W	6	N-M, N-F	1.25:1
3114N	12.4	N-M, N-F	1.35:1
TN180-50W	18	N-M, N-F	1.45:1
TB040-50W	4	BNC-M, BNC-F	1.25:1
3114B	4	BNC-M, BNC-F	1.25:1
TD020-50W	2.5	7/16 DIN-M, 7/16 DIN-F	1.25:1
TD075-50W	7.5	7/16 DIN-M, 7/16 DIN-F	1.45:1
3114D	7.5	7/16 DIN-M, 7/16-DIN-F	1.25:1
TT060-50W	6	TNC-M, TNC-F	1.25:1
TT180-50W	18	TNC-M, TNC-F	1.45:1
3114T	12.4	TNC-M, TNC-F	1.35:1

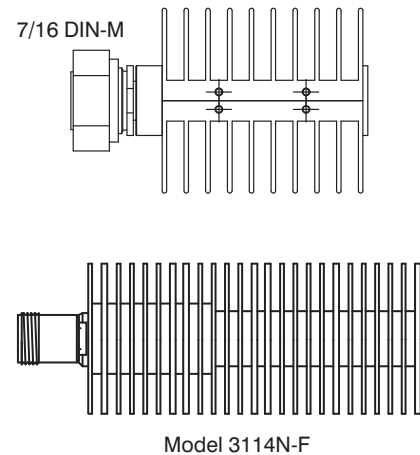

Termination Reference Guide

MODEL NO. FREQ. (GHz) CONNECTOR VSWR

100 Watt Terminations, Convection Cooled

TS020-100W	2.5	SMA-M, SMA-F	1.30:1
TS060-100W	6	SMA-M, SMA-F	1.40:1
TN020-100W	2.5	N-M, N-F	1.30:1
TN060-100W	6	N-M, N-F	1.40:1
TB020-100W	2.5	BNC-M, BNC-F	1.35:1
TB040-100W	4	BNC-M, BNC-F	1.45:1
TT020-100W	2.5	TNC-M, TNC-F	1.30:1
TT060-100W	6	TNC-M, TNC-F	1.40:1
TD020-100W	2.5	7/16 DIN-M, 7/16 DIN-F	1.35:1
TD075-100W	6	7/16 DIN-M, 7/16 DIN-F	1.45:1

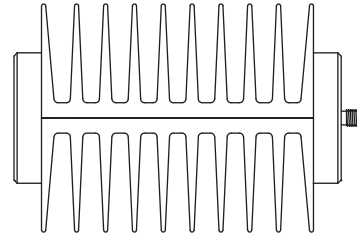

SMA-F

150 Watt Terminations, Convection Cooled

TS020-150W	2.5	SMA	1.25:1
TS040-150W	4	SMA	1.35:1
TN020-150W	2.5	N-M, N-F	1.25:1
TN040-150W	4	N-M, N-F	1.35:1
TT020-150W	2.5	TNC-M, TNC-F	1.25:1
TT040-150W	4	TNC-M, TNC-F	1.35:1
TD020-150W	2.5	7/16 DIN-M, 7/16 DIN-F	1.30:1
TD040-150W	4	7/16 DIN-M, 7/16 DIN-F	1.40:1

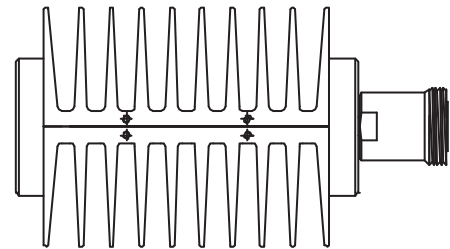

7/16 DIN-F

300 Watt Terminations, Convection Cooled

TS020-300W	2.5	SMA-M, SMA-F	1.30:1
TS040-300W	4	SMA-M, SMA-F	1.35:1
TN020-300W	2.5	N-M, N-F	1.30:1
TN040-300W	4	N-M, N-F	1.35:1
TT020-300W	2.5	TNC-M, TNC-F	1.25:1
TT040-300W	4	TNC-M, TNC-F	1.35:1
TD020-300W	2.5	7/16 DIN-M, 7/16 DIN-F	1.35:1
TD040-300W	4	7/16 DIN-M, 7/16 DIN-F	1.35:1

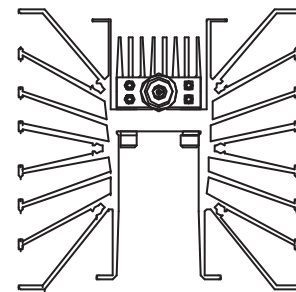

Type N

Adapter Reference Guide







Adapters

Connector	F	7/16	BNC	N	TNC	7mm	SMA	3.5mm	2.9mm	GPO TM /SMP	2.4mm	1.85mm
F	①		①②	①②	②		②					
7/16				③								
BNC	①②											
N	①②	③					③					
TNC	②											
7mm												
SMA	②			③			③					
3.5mm												
2.9mm												
GPO TM /SMP												
2.4mm												
1.85mm												

- ① Adapter, 75 Ω both sides (page 16)
- ② Impedance Matching Pad where F connector only is 75 Ω (page 5)
- ③ Also available with Quick Connect Option

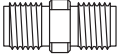
Note: Highlighted squares denote available connector configurations

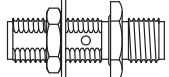
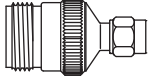
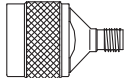
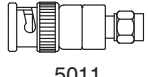
Adapter Reference Guide

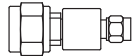
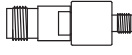
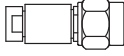
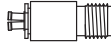
CONNECTORS	MODEL NO.	FREQ. (Ghz)	VSWR	DESCRIPTION	
SMA In Series Adapters					
F/F with O-Ring Seal	5211-137	3	1.10:1	Bulkhead Feedthru	
F/F M/M M/F	5010, 5020, 5030	18	1.20:1		
F/F M/M M/F	5043, 5044, 5045	18	1.20:1	Gold Plated	
M/F	5030Q	18	1.25:1	Quick Connect	
M/M F/F	5312, 5313	18	1.25:1	Flange Mount, 0.5" Sq	
M/F F/F	5311A, 5313A	18	1.20:1	Flange Mount, 0.5" Sq.	
F/F with O-Ring Seal	5211	18	1.15:1	Bulkhead Feedthru	
F/F (Au is Gold Plated)	5205, 5205/Au	18	1.15:1	Bulkhead Feedthru	
F/F M/M M/F	5163, 5164, 5165	26.5	1.20:1		
F/F with O-Ring Seal	5218	26.5	1.30:1	Bulkhead Feedthru	
SMA Between Series Adapters					
SMA-M N-M	5061	6	1.30:1	Ultra Low Cost Brass	
SMA-M N-F	5062	6	1.30:1	Ultra Low Cost Brass	
SMA-F N-M	5063	6	1.30:1	Ultra Low Cost Brass	
SMA-F N-F	5064	6	1.30:1	Ultra Low Cost Brass	
SMA-M N-M	5056	18	1.25:1	Short Profile	
SMA-M N-F	5057	18	1.25:1	Short Profile	
SMA-F N-F	5058	18	1.25:1	Short Profile	
SMA-F N-M	5059	18	1.25:1	Short Profile	
SMA-M N-M	5106	18	1.12:1	Precision	
SMA-M N-F	5107	18	1.12:1	Precision	
SMA-F N-M	5108	18	1.12:1	Precision	
SMA-F N-F	5109	18	1.12:1	Precision	
SMA-M N-F	5057Q	18	1.30:1	Quick Connect	
SMA-M N-M	5306	18	1.12:1	Flange Mount 1" Sq.	
SMA-M N-F	5307	18	1.12:1	Flange Mount 1" Sq.	
SMA-F N-M	5308	18	1.12:1	Flange Mount 1" Sq.	
SMA-F N-F	5309	18	1.12:1	Flange Mount 1" Sq.	
SMA-F N-F	5209	18	1.20:1	Bulkhead Feedthru	
SMA-M N-F	5210	18	1.20:1	Bulkhead Feedthru	
SMA-F N-F w/ O-Ring Seal	5212	18	1.20:1	Bulkhead Feedthru	
SMA-M N-F w/ O-Ring Seal	5213	18	1.20:1	Bulkhead Feedthru	
SMA-M BNC-M	5011	8	1.25:1		
SMA-M BNC-F	5012	8	1.25:1		
SMA-F BNC-M	5013	8	1.25:1		
SMA-F BNC-F	5014	8	1.25:1		
SMA-M TNC-M	5015	18	1.25:1		
SMA-M TNC-F	5016	18	1.25:1		
SMA-F TNC-M	5017	18	1.25:1		
SMA-F TNC-F	5018	18	1.25:1		
SMA-M GPO-M	5190G	18	1.20:1	Full Detent	
SMA-M GPO-M	5190GL	18	1.20:1	Limited Detent	
SMA-F GPO-M	5191G	18	1.20:1	Full Detent	
SMA-F GPO-M	5191GL	18	1.20:1	Limited Detent	
SMA-M GPO-F	5192G	18	1.20:1		
SMA-F GPO-F	5193G	18	1.20:1		
SMA-M SMP-M	5190P	18	1.20:1	Full Detent	
SMA-M SMP-M	5190PL	18	1.20:1	Limited Detent	
SMA-F SMP-M	5191P	18	1.20:1	Full Detent	
SMA-F SMP-M	5191PL	18	1.20:1	Limited Detent	





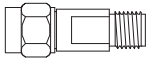
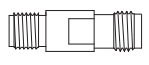
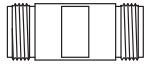
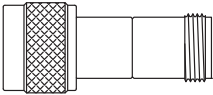
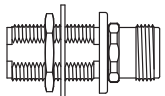
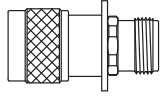
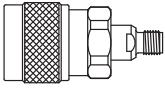
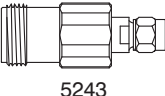
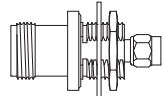
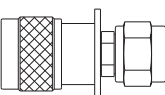
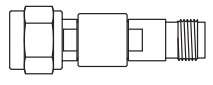





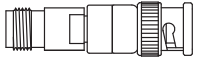
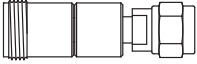
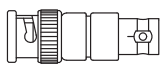
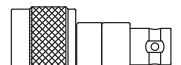

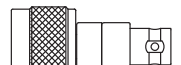
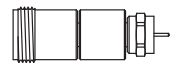
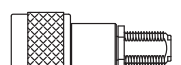



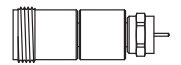
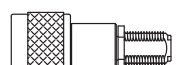

Adapter Reference Guide

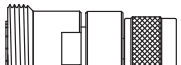

CONNECTORS	MODEL NO.	FREQ. (Ghz)	VSWR	DESCRIPTION	
SMA Between Series Adapters, Continued					
SMA-M SMP-F	5192P	18	1.20:1		
SMA-F SMP-F	5193P	18	1.20:1		
SMA-M 3.5mm-M	5246	18	1.25:1		5247
SMA-M 3.5mm-F	5247	18	1.25:1		
SMA-F 3.5mm-M	5248	18	1.25:1		
SMA-F 3.5mm-F	5249	18	1.25:1		
SMA-F 1.85mm-M	5250	18	1.30:1		5253
SMA-M 1.85mm-M	5251	18	1.30:1		
SMA-M 1.85mm-F	5252	18	1.30:1		
SMA-F 1.85mm-F	5253	18	1.30:1		
TYPE N In Series					
F/F M/M M/F	5185, 5188, 5189	6	1.20:1	Ultra Low Cost, Brass	
F/F	5303-067	6	1.07:1	Flange Mount 1" sq.	
M/M	5304-067	6	1.07:1	Flange Mount 1" sq.	
M/F	5305-067	6	1.07:1	Flange Mount 1" sq.	
F/F M/M M/F	5003, 5004, 5005	18	1.25:1		
F/F M/M M/F	5103, 5104, 5105	18	1.12:1	Precision	5005
F/F	5208	18	1.15:1	Bulkhead Feedthru	
F/F with O-Ring Seal	5215	18	1.15:1	Bulkhead Feedthru	
F/F M/M M/F	5303, 5304, 5305	18	1.12:1	Flange Mount 1" sq.	
TYPE N Between Series					
N-M TNC-M	5326	18	1.12:1	Flange Mount 1" sq.	
N-M TNC-F	5327	18	1.12:1	Flange Mount 1" sq.	
N-F TNC-M	5328	18	1.12:1	Flange Mount 1" sq.	
N-F TNC-F	5329	18	1.12:1	Flange Mount 1" sq.	5208
N-M BNC-M	5330	8	1.20:1	Flange Mount 1" sq.	
N-M BNC-F	5331	8	1.20:1	Flange Mount 1" sq.	
N-F BNC-M	5332	8	1.20:1	Flange Mount 1" sq.	
N-F BNC-F	5333	8	1.20:1	Flange Mount 1" sq.	5305
N-F 2.4mm-M	5155	18	1.15:1		
N-F 2.4mm-F	5156	18	1.15:1		
N-M 2.4mm-M	5157	18	1.15:1		
N-M 2.4mm-F	5158	18	1.15:1		
N-M 2.9mm-M	5166	18	1.15:1	Precision	5145
N-F 2.9mm-F	5167	18	1.15:1	Precision	
N-M 2.9mm-F	5168	18	1.15:1	Precision	
N-F 2.9mm-M	5169	18	1.15:1	Precision	
N-M 3.5mm-M	5144	18	1.12:1		
N-M 3.5mm-F	5145	18	1.12:1		5243
N-F 3.5mm-M	5146	18	1.12:1		
N-F 3.5mm-F	5147	18	1.12:1		
N-M 1.85mm-M	5242	18	1.25:1		
N-F 1.85mm-M	5243	18	1.25:1		
N-M 1.85mm-F	5244	18	1.25:1		
N-F 1.85mm-F	5245	18	1.25:1		
N-F SMA-F	5293	12.4	1.20:1	Bulkhead Feedthru	5207
N-F SMA-F w/O-Ring	5294	12.4	1.20:1	Bulkhead Feedthru	
N-M SMA-F	5206	18	1.30:1	Bulkhead Feedthru	
N-F SMA-F	5203	18	1.12:1	Bulkhead Feedthru	
N-F SMA-M	5207	18	1.12:1	Bulkhead Feedthru	
N-F SMA-M w/ O-Ring	5216	18	1.12:1	Bulkhead Feedthru	
N-F SMA-F w/ O-Ring	5217	18	1.12:1	Bulkhead Feedthru	5326
TNC In Series					
F/F M/M M/F	5186, 5187, 5194	6	1.20:1	Ultra Low Cost, Brass	
M/F F/F M/M	5040, 5041, 5042	18	1.20:1		



Adapter Reference Guide

CONNECTORS			MODEL NO.	FREQ.	VSWR	DESCRIPTION	
TNC Between Series				(Ghz)			
TNC-M	BNC-M		5034	8	1.30:1		
TNC-F	BNC-M		5035	8	1.30:1		
TNC-M	BNC-F		5036	8	1.30:1		
TNC-F	BNC-F		5037	8	1.30:1		
TNC-M	N-F		5026	18	1.25:1		
TNC-F	N-F		5027	18	1.25:1		
TNC-M	N-M		5028	18	1.25:1		
TNC-F	N-M		5029	18	1.25:1		
TNC-M	N-M		5126	18	1.12:1	Precision	
TNC-F	N-M		5127	18	1.12:1	Precision	
TNC-M	N-F		5128	18	1.12:1	Precision	
TNC-F	N-F		5129	18	1.12:1	Precision	
BNC In Series							
M/F	F/F	M/M	5031, 5032, 5033	8	1.25:1		
M/F	F/F	M/M	5087, 5088, 5089	3	1.30:1	75 Ω	
BNC Between Series							
BNC-M	N-M		5021	8	1.30:1		
BNC-F	N-M		5022	8	1.30:1		
BNC-M	N-F		5023	8	1.30:1		
BNC-F	N-F		5024	8	1.30:1		
BNC-M	N-M		5130	8	1.15:1	Precision	
BNC-F	N-M		5131	8	1.15:1	Precision	
BNC-M	N-F		5132	8	1.15:1	Precision	
BNC-F	N-F		5133	8	1.15:1	Precision	
TYPE F In Series							
M/F	M/M	F/F	5230, 5231, 5232	3	1.30:1	75 Ω	
TYPE F Between Series							
F-M	N-M		5195	3	1.30:1	75 Ω Both Sides	
F-M	N-F		5196	3	1.30:1	75 Ω Both Sides	
F-F	N-M		5197	3	1.30:1	75 Ω Both Sides	
F-F	N-F		5198	3	1.30:1	75 Ω Both Sides	
F-M	BNC-M		5070	3	1.30:1	75 Ω Both Sides	
F-M	BNC-F		5071	3	1.30:1	75 Ω Both Sides	
F-F	BNC-M		5072	3	1.30:1	75 Ω Both Sides	
F-F	BNC-F		5073	3	1.30:1	75 Ω Both Sides	
7/16 DIN In Series							
F/F	M/M	M/F	5701, 5702, 5703	7.5	1.35:1		
7/16 DIN Between Series							
7/16 DIN-F	N-F		5704	7.5	1.35:1		
7/16 DIN-F	N-M		5705	7.5	1.35:1		
7/16 DIN-M	N-F		5706	7.5	1.35:1		
7/16 DIN-M	N-M		5707	7.5	1.35:1		
7/16 DIN-M	N-F		5706Q	7.5	1.35:1	Quick Connect	
7/16 DIN-M	N-M		5707Q	7.5	1.35:1	Quick Connect	
7/16 DIN-F	TNC-F		5708	7.5	1.35:1		
7/16 DIN-F	TNC-M		5709	7.5	1.35:1		
7/16 DIN-M	TNC-F		5710	7.5	1.35:1		
7/16 DIN-M	TNC-M		5711	7.5	1.35:1		
1.85mm In Series							
F/F	M/M	M/F	5173, 5174, 5175	65	1.40:1		
M/F			5292	65	1.50:1	Bulkhead Feedthru	
F/F with O-Ring Seal			5289	65	1.40:1	Bulkhead Feedthru	
F/F without O-Ring Seal			5290	65	1.40:1	Bulkhead Feedthru	
2.4mm In Series							
F/F	M/M	M/F	5148, 5149, 5150	50	1.30:1		
F/F with O-Ring Seal			5221	50	1.35:1	Bulkhead Feedthru	
2.4mm Between Series							
2.4mm-M	SMA-M		5080	26.5	1.20:1		
2.4mm-F	SMA-M		5081	26.5	1.20:1		

Adapter Reference Guide

CONNECTORS	MODEL NO.	FREQ. (Ghz)	VSWR	DESCRIPTION
2.4mm Between Series, Continued				
2.4mm-M SMA-F	5082	26.5	1.20:1	
2.4mm-F SMA-F	5083	26.5	1.20:1	
2.4mm-M 3.5mm-M	5065	34	1.25:1	
2.4mm-M 3.5mm-F	5066	34	1.25:1	
2.4mm-F 3.5mm-M	5067	34	1.25:1	
2.4mm-F 3.5mm-F	5068	34	1.25:1	
2.4mm-F 2.9mm-F	5151	40	1.30:1	
2.4mm-F 2.9mm-M	5152	40	1.30:1	
2.4mm-M 2.9mm-F	5153	40	1.30:1	
2.4mm-M 2.9mm-M	5154	40	1.30:1	
2.4mm-M 1.85mm-M	5075	50	1.35:1	
2.4mm-M 1.85mm-F	5076	50	1.35:1	
2.4mm-F 1.85mm-M	5077	50	1.35:1	
2.4mm-F 1.85mm-F	5078	50	1.35:1	
2.9mm In Series				
F/F M/M M/F	5160, 5161, 5162	26.5	1.15:1	
F/F	5338	26.5	1.25:1	Flange Mount, 0.5" sq.
F/F M/M M/F	5170, 5171, 5172	40	1.30:1	
F/F with O-Ring Seal	5214	40	1.30:1	Bulkhead Feedthru
M/F	5223	40	1.35:1	Bulkhead Feedthru
F/F	5344	40	1.35:1	Flange Mount, 0.5" sq.
2.9mm Between Series				
2.9mm-M SMA-M	5262	26.5	1.25:1	
2.9mm-M SMA-F	5263	26.5	1.25:1	
2.9mm-F SMA-M	5264	26.5	1.25:1	
2.9mm-F SMA-F	5265	26.5	1.25:1	
2.9mm-F 3.5mm-F	5266	34	1.25:1	
2.9mm-F 3.5mm-M	5267	34	1.25:1	
2.9mm-M 3.5mm-F	5268	34	1.25:1	
2.9mm-M 3.5mm-M	5269	34	1.25:1	
2.9mm-M 1.85mm-M	5258	40	1.40:1	
2.9mm-M 1.85mm-F	5259	40	1.40:1	
2.9mm-F 1.85mm-M	5260	40	1.40:1	
2.9mm-F 1.85mm-F	5261	40	1.40:1	
2.9mm-F 2.4mm-F w/ O-Ring	5237	40	1.35:1	Bulkhead Feedthru
3.5mm In Series				
M/F M/M F/F	5084, 5085, 5086	34	1.25:1	
3.5mm Between Series				
3.5mm-F 1.85mm-M	5254	34	1.30:1	
3.5mm-M 1.85mm-F	5255	34	1.30:1	
3.5mm-F 1.85mm-F	5256	34	1.30:1	
3.5mm-M 1.85mm-M	5257	34	1.30:1	
7mm Between Series				
7mm SMA-M	5110	18	1.12:1	
7mm SMA-F	5111	18	1.12:1	
7mm N-M	5112	18	1.12:1	
7mm N-F	5113	18	1.12:1	
7mm TNC-M	5114	18	1.12:1	
7mm TNC-F	5115	18	1.12:1	
7mm 3.5mm-M	5140	18	1.08:1	
7mm 3.5mm-F	5141	18	1.08:1	
7mm 2.4mm-M	5181	18	1.10:1	
7mm 2.4mm-F	5182	18	1.10:1	
7mm 2.9mm-M	5183	18	1.10:1	
7mm 2.9mm-F	5184	18	1.10:1	
7mm SMA-M	5314	18	1.12:1	Flange Mount 1" sq.
7mm SMA-F	5315	18	1.12:1	Flange Mount 1" sq.

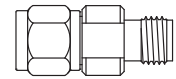

5153

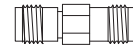

5078

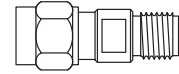

5162

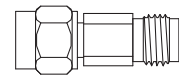

5255

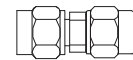

5257

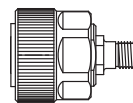

5111

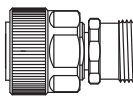

5113

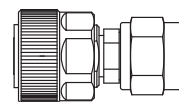

5114



DC Block Reference Guide

Inmet inner DC blocks have a capacitor in-series with the center conductor which prevents the flow of audio and direct current (DC) frequencies while offering minimum interference to RF signals up to 50GHz. Similarly outer DC blocks have a capacitor in-series with the outer conductor and the inner/outer types have capacitors in-series with both inner and outer conductors.

Insulation material on the outer DC blocks is a PEEK shell. Applications include ground loop elimination, signal source modulation leakage suppression, system signal-to-noise ratio improvement, test setup isolation and other situations where undesired DC or audio current flows in the system.

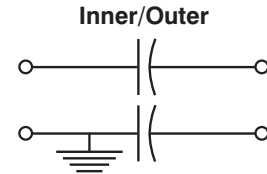
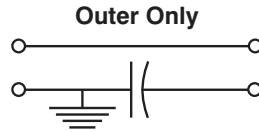
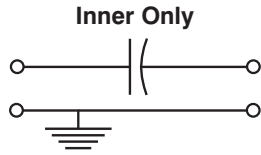

MODEL NO.	FREQ. (GHz)	CONNECTOR	VOLTAGE	BLOCK TYPE
-----------	-------------	-----------	---------	------------

DC Blocks, SMA

8037	0.01-18	SMA-M/F	200	INNER
8038	0.01-18	SMA-M/F	200	OUTER
8039	0.01-18	SMA-M/F	200	INNER-OUTER

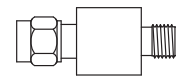

Models 8038 and 8039

DC Blocks, SMA Microminiature

8055	0.01-18	SMA-M/F	200	INNER
8055H	0.01-18	SMA-M/F	200	INNER

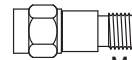

Model 8055

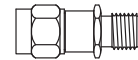

with Hex

DC Blocks

8046	0.01-18	N-M/F	200	INNER
8047	0.01-18	N-M/F	200	OUTER
8048	0.01-18	N-M/F	200	INNER/OUTER
8080	0.01-4	BNC-M/F	200	INNER
8081	0.01-4	BNC-M/F	200	OUTER
8082	0.01-4	BNC-M/F	200	INNER/OUTER
8070	0.01-18	TNC-M/F	200	INNER
8071	0.01-18	TNC-M/F	200	OUTER
8072	0.01-18	TNC-M/F	200	INNER/OUTER
8060A	0.007-26.5	2.9mm-M/F	50	INNER
8063A	0.007-26.5	2.9mm-F/F	50	INNER
8066A	0.007-26.5	2.9mm-M/M	50	INNER
8061	0.01-26.5	2.9mm-M/F	200	OUTER
8062A	0.01-26.5	2.9mm-M/F	200	INNER/OUTER
8141A	0.01-40	2.9mm-M/F	200	INNER
8142	0.01-40	2.9mm-M/F	200	OUTER
8143A	0.01-40	2.9mm-M/F	200	INNER/OUTER
8144A	0.01-40	2.9mm-F/F	200	INNER
8145	0.01-40	2.9mm-F/F	200	OUTER
8146A	0.01-40	2.9mm-F/F	200	INNER/OUTER
8177	0.01-50	2.4mm-M/F	75	INNER
8178	0.01-50	2.4mm-M/F	75	OUTER
8179	0.01-50	2.4mm-M/F	75	INNER/OUTER
8100	0.30-2.5	7/16-M/F	100	INNER



Model 8046

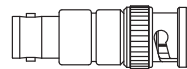

Model 8080

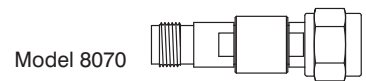

Model 8070

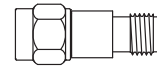

Model 8060A

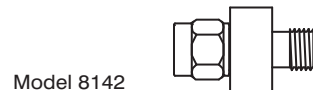

Model 8142

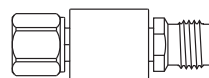

Model 8179

DC Blocks, High Voltage

8529A, AH	0.1-4	SMA-M/F	900	INNER
8532-SI-HV	0.1-18	SMA-M/F	950	INNER
8532-NI-HV	0.1-18	N-M/F	950	INNER
8532-TI-HV	0.1-18	TNC-M/F	950	INNER
8550	0.8-2.8	7/16-M/F	3000	INNER

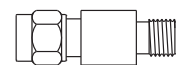

Model 8532-SI-HV

DC Block Reference Guide

MODEL NO. FREQ. (GHz) CONNECTOR VOLTAGE BLOCK TYPE

DC Blocks, Broadband

8535	7 kHz-23	SMA-M/F	100	INNER
8535G, 8535GL	7 kHz-26.5	GPO-M/F	50	INNER
8535P, 8535PL	7 kHz-26.5	SMP-M/F	50	INNER
8535K, 8535KH	7 kHz-40	2.9mm-M/F	35	INNER
8535E	7 kHz-50	2.4mm-M/F	35	INNER
8535MP	16kHz-50	SMPM-M/F	10	INNER

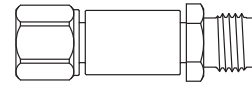

Model 8535E

Note: GPO™ and SMP male connectors are available in full and limited detent.

75 Ohm DC Blocks, In Series

8174	0.01-2	F-M/F	200	INNER
8175	0.01-2	F-M/F	200	OUTER
8176	0.01-2	F-M/F	200	INNER-OUTER
8184	0.1-4	N-M/F	200	INNER
8185	0.1-4	N-M/F	200	OUTER
8186	0.1-4	N-M/F	200	INNER/OUTER
8181	0.1-4	BNC-M/F	200	INNER
8182	0.1-4	BNC-M/F	200	OUTER
8183	0.1-4	BNC-M/F	200	INNER/OUTER

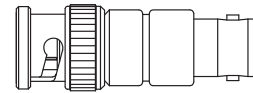

Model 8181

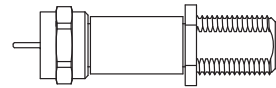

Model 8174

DC Blocks, Between Series

8313	0.01-4	BNC-M/SMA-F	100	INNER
8301	0.01-18	N-M/SMA-M	200	INNER
8302	0.01-18	N-M/SMA-F	200	INNER
8303	0.01-18	N-F/SMA-M	200	INNER
8304	0.01-18	N-F/SMA-F	200	INNER
8306	0.01-40	2.4mm-M/2.9mm-F	200	INNER
8309	0.01-40	2.4mm-F/2.9mm-M	200	INNER
8180	0.01-40	2.4mm-F/2.9mm-F	200	INNER

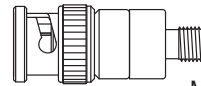

Model 8313

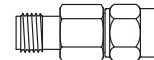

Model 8306

MODEL NO. FREQ. (GHz) CONNECTOR VSWR ATTN (dB)

2 Watt DC Blocking Attenuators (Also See Attenuator Section, page 6)

8516S-XX	0.01-2	SMA-M/F	1.15:1	0-10,12,15,20
----------	--------	---------	--------	---------------

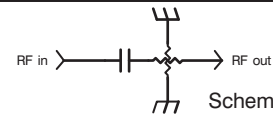

Schematic Diagram

DC Blocking Terminations (Also see Termination Section, Page 10)

8530S	30 kHz-18	SMA-M, SMA-F	100	INNER
8530N	30 kHz-18	N-M, N-F	100	INNER
8530PF	30 kHz-23	SMP-F	100	INNER
8541-MPF	100 kHz-50	SMPM-F	10	INNER

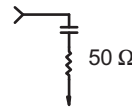

Schematic Diagram

DC Blocking Connectors (Accepts *0.009 and 0.012" Dia. Pins)

8537KF	20 kHz-45	2.9mm-F	25	INNER
8537KM	20 kHz-45	2.9mm-M	25	INNER
8537VF*	25 kHz-50	1.85mm-F	25	INNER
8537VM*	25 kHz-50	1.85mm-M	25	INNER

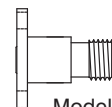

Model 8537KF



Bias Tee Reference Guide

MODEL NO. FREQ. (GHz) CONN. CURRENT (Max.) VOLTAGE (Max.)

General Purpose and High Power Bias Tees

8800SMF1-02	.01-2.5	SMA-M/F	2.5A	100V
8800SMF1-04	.01-4	SMA-M/F	2.5A	100V
8800SMF1-06	.01-6	SMA-M/F	2.5A	100V
8800SMF1-09	.01-9	SMA-M/F	2.5A	100V
8800SMF1-12	.01-12.4	SMA-M/F	2.5A	100V
8800NMF1-02	.01-2.5	N-M/F	2.5A	100V
8800NMF1-04	.01-4	N-M/F	2.5A	100V
8800NMF1-06	.01-6	N-M/F	2.5A	100V
8800NMF1-09	.01-9	N-M/F	2.5A	100V
8800NMF1-12	.01-12.4	N-M/F	2.5A	100V
8800DMF1-02	.01-2.5	7/16-M/F	2.5A	100V
8800DMF1-04	.01-4	7/16 DIN-M/F	2.5A	100V
8800DMF1-06	.01-6	7/16-M/F	2.5A	100V
8800DMF1-07	.01-7.5	7/16-M/F	2.5A	100V

High Current Bias Tees

8820SMF1-02	.5-2.5	SMA-M/F	7.0A	100V
8820NMF1-02	.5-2.5	N-M/F	7.0A	100V
8820DMF1-02	.5-2.5	7/16-DIN-M/F	7.0A	100V
8821DMF1-02*	.5-2.5	7/16-DIN-M/F	7.0A	100V

Pulsed Bias Tees

8860SMF2-02	.03-2.5	SMA-M/F	3.0A	100V
8860SMF2-06	.03-6	SMA-M/F	3.0A	100V
8860SMF2-09	.03-9	SMA-M/F	3.0A	100V
8860SMF2-12	.03-12	SMA-M/F	3.0A	100V

75 Ohm Bias Tees

8875NMF1-03	.01-3	N-M/F	2.5A	100V
8875FMF1-03	.01-3	F-M/F	2.5A	100V

Broadband Bias Tees

8810SMF2-12	50 kHz-12.4	SMA-M/F	750mA	25V
8810SMF2-18	50 kHz-18	SMA-M/F	750mA	25V
8810SMF2-26	50 kHz-26.5	SMA-M/F	750mA	25V
8810KMF2-26	50 kHz-26.5	2.9mm-M/F	750mA	25V
8810KMF2-40	50 kHz-40	2.9mm-M/F	150mA	25V
8812KMF2-26	12 kHz-26.5	2.9mm-M/F	150mA	16V
8812KMF2-40	12 kHz-40	2.9mm-M/F	150mA	16V
8810EMF2-50	50 kHz-50	2.4mm-M/F	150mA	25V

*Environmentally Sealed

Bias Tee Numbering System

88 = Bias Tee Product Family

Product Series

- 00 = General Purpose Series
- 10 = Broadband Series
- 20 = High Power Series
- 21 = Environmentally Sealed
- 60 = Pulsed Bias Tees
- 75 = 75 Ohm

RF Connector Type

- E = 2.4mm D = 7/16 DIN
- K = 2.9mm T = TNC
- N = Type N B = BNC
- S = SMA F = F

RF Connector Sex

- MF = Male "AC+DC" Connector
- Female "AC" Connector
- FF = Both Connectors Female
- MM = Both Connectors Male
- FM = Female "AC+DC" Connector
- Male "AC" Connector

DC Connector Type

- 1 = Solder Post
- 2 = SMA Female
- 3 = BNC Female
- 4 = F Type Female

Frequency

8810EMF1-50

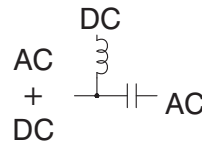
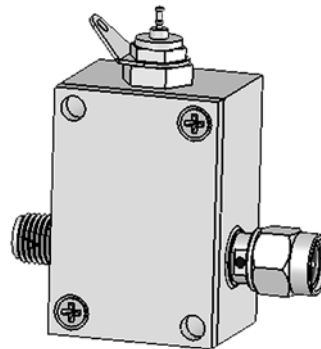

Model 8800SFM1

Equalizer Overview



Aeroflex / Inmet Gain Equalizers offer simple solutions to your system slope problems. Negative, Positive, Parabolic or Fine Grain Ripple slope units can be built to meet your desired performance parameters in the DC-40 GHz frequency range. Features include:

- DC to 40 GHz, high performance
- Broadband or narrowband frequency performance
- Fine grain tuning capability
- Standard connectors: SMA, 2.9mm, N, TNC, SMP, 2.4mm
- Meets MIL-SPEC environmental requirements
- Tubular and rectangular available depending on slope and frequency requirements.

Gain equalizers are passive microwave components that have an insertion loss characteristic that varies as a function of frequency. Aeroflex / Inmet can supply both standard and custom-designed equalizers to meet the needs of commercial and military customers alike. Aeroflex / Inmet has the engineering staff devoted exclusively to this product line and can supply designs that precisely define a preset loss characteristic (fixed equalizers) or with the ability to be loss-adjusted to custom-fit the particular variable requirements needed to field-tune a system. Each equalizer application has an insertion loss characteristic and package configuration that is unique. Equalizers can be custom made to meet the desired performance parameters and package configurations for each application.

NEGATIVE SLOPE equalizers are typically used for applications to offset the excessive loss of long cable runs at high frequencies. The loss characteristic of the equalizer decreases linearly with frequency.

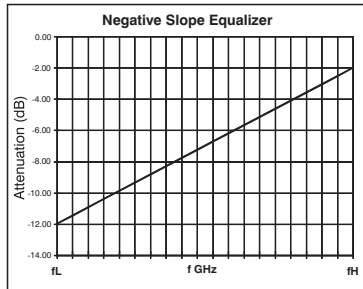

POSITIVE SLOPE equalizers are typically used for applications to offset excessive loss of low frequencies where waveguide transmission characteristics require an equalizer that has increasing attenuation with frequency.

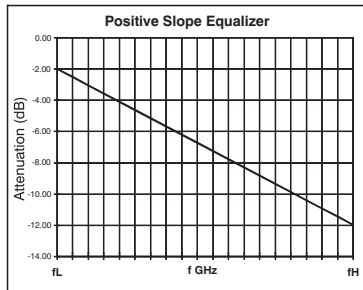

PARABOLIC equalizers are used in applications where a broadband traveling wave tube (TWT) or solid state amplifier (SSA) has maximum gain at or near the center of the frequency band. The characteristics of the equalizer require maximum attenuation at mid-band and decreasing attenuation at band edges. Conversely, an inverted parabolic equalizer has decreased attenuation at mid-band and increasing attenuation at band edges.

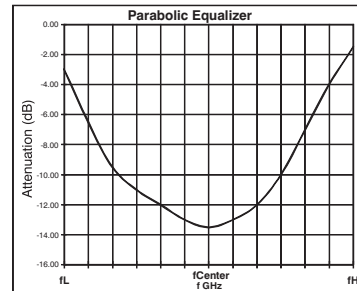

RIPPLE equalizers are used to flatten, gain ripple and spikes in a broadband application. The narrow band attenuation is adjustable in the bands where the ripple or spikes occur and flatten the response in these sub bands.

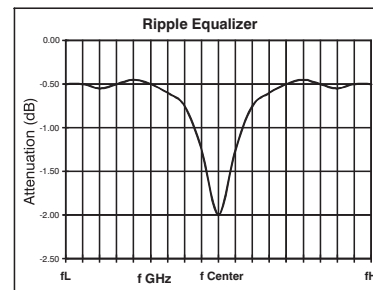

Standard Model Gain Equalizers

MODEL NO.	FREQ. (GHz)	Slope	Connectors
-----------	-------------	-------	------------

Equalizers (A Selection of Standard Models)

EQ1251	2-18 GHz	Negative Slope	SMA/TNC/Type N
EQ2301	.5-18 GHz	Negative Slope	SMA/TNC/Type N
EQ2400	6-18 GHz	Negative Slope	SMA/TNC/Type N
EQ2401	8-18 GHz	Negative Slope	SMA/TNC/Type N
EQ2402	2-18 GHz	Positive Slope	SMA/TNC/Type N

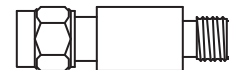

EQ1251-SMA Shown

Power Dividers

Wilkinson Power Dividers

Model	Connector	Frequency	Insertion Loss Max.	Phase Balance Max.	Isolation Min.
PD0001-S2	SMA	0.5 - 1.0 GHz	0.25 dB	2°	22 dB
PD0102-S2	SMA	1.0 - 2.0 GHz	0.25 dB	3°	22 dB
PD0002-S2	SMA	0.8 - 2.5 GHz	0.40 dB	3°	20 dB
PD0204-S2	SMA	2.0 - 4.0 GHz	0.30 dB	4°	20 dB
PD0004-S2	SMA	0.5 - 4.0 GHz	0.50 dB	4°	20 dB
PD0408-S2	SMA	4.0 - 8.0 GHz	0.35 dB	4°	20 dB
PD0208-S2	SMA	2.0 - 8.0 GHz	0.40 dB	4°	20 dB
PD0818-S2	SMA	8.0 - 18.0 GHz	0.60 dB	5°	20 dB
PD0218-S2	SMA	2.0 - 18.0 GHz	1.00 dB	5°	17 dB
PD0102-S4	SMA	1.0 - 2.0 GHz	0.60 dB	4°	20 dB

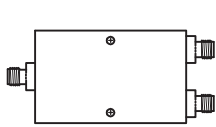

Model PD0001-S2

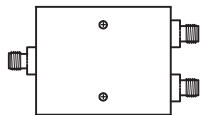

Model PD0102-S2

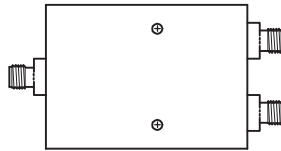

Model PD0002-S2

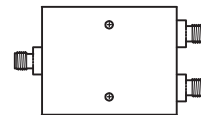

Model PD0204-S2

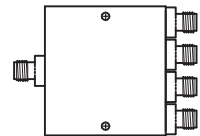

Model PD0102-S4

Wilkinson Power Dividers, GPS 2-Way, Type N

Model	Connector	Frequency	DC Power	DC Resistance (Input to Output)	Isolation Min.
PD1516-N2	Type N	1.5 - 1.6 GHz	12V 2 Amp Max.	0.1 Ohm Max.	22 dB

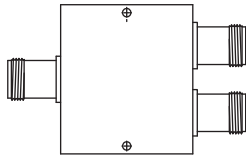

Model PD1516-N2

Resistive Power Dividers

Model	Connector	Frequency	Insertion Loss Max.	Phase Balance Max.	Amplitude Balance Max.
6007-02	Type N	12.4 GHz	6.0dB	±2°	0.4 dB
6007	Type N	18.0 GHz	7.5dB	±3°	0.5 dB
6011-02	Type N	12.4 GHz	6.0dB	±2°	0.4 dB
6011	Type N	18.0 GHz	7.5 dB	±3°	0.5 dB
6019-02	TNC	12.4 GHz	6.0dB	±2°	0.4 dB
6019	TNC	18.0 GHz	7.5 dB	±3°	0.5 dB
6014-03	SMA	6.0 GHz	6.0dB	±2°	0.4 dB
6014F-03	SMA	6.0 GHz	6.0dB	±2°	0.4 dB
6014-01	SMA	12.4 GHz	6.0dB	±2°	0.4 dB
6014F-01	SMA	12.4 GHz	6.0dB	±2°	0.4 dB
6014-02	SMA	18.0 GHz	7.5 dB	±3°	0.5 dB
6014F-02	SMA	18.0 GHz	7.5 dB	±3°	0.5 dB
6005-01	2.9mm	12.4 GHz	6.0dB	±2°	0.4 dB
6005F-01	2.9mm	12.4 GHz	6.0dB	±2°	0.4 dB
6005-02	2.9mm	18.0 GHz	7.5dB	±3°	0.5 dB
6005F-02	2.9mm	18.0 GHz	7.5dB	±3°	0.5 dB
6005-03	2.9mm	26.5 GHz	8.5dB	±4°	1.0 dB

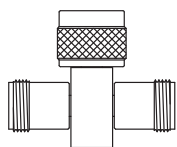

Model 6007

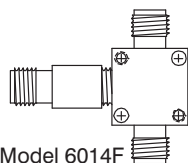

Model 6014F

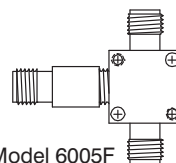

Model 6005F

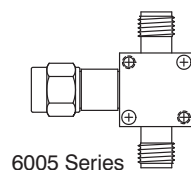

6005 Series

Directional Couplers, Opens & Shorts, Detectors, Dust Caps



Directional Couplers

MODEL NO.	FREQ. (MHz)	CONNECTOR	Coupling (dB)
6910S	1850-1910	SMA-RT Angle	10
6911S	1850-1910	SMA	10
6910Q	1850-1910	QMA	10
6912S	824-849	SMA	10
6912Q	824-849	QMA	10
6913S	824-849	SMA-RT Angle	10

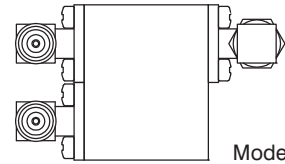

Model 6910S

Open Circuits (also available with chain, add suffix "C")

MODEL NO.	FREQ. (GHz)	CONNECTOR	
7004	18	N-M	
7005	18	N-F	
7006	18	SMA-M	
7007	18	SMA-F	
7013	7.5	7/16 DIN-F	
7014	7.5	7/16 DIN-M	
7015	3	F-M	75 Ohm
7016	3	F-F	75 Ohm

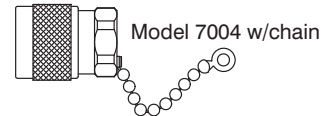

Model 7004 w/chain

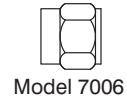

Model 7006

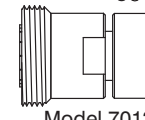

Model 7013

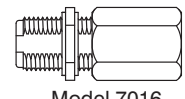

Model 7016

Short Circuits (also available with chain, add suffix "C")

7001	18	N-M	
7002	18	N-F	
7008	18	SMA-M	
7009	18	SMA-F	
7011	7.5	7/16 DIN-F	
7012	7.5	7/16 DIN-M	
7017	3	F-M	75 Ohm
7018	3	F-F	75 Ohm



Model 7002



Model 7009

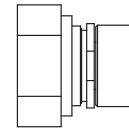

Model 7012

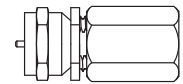

Model 7017

Zero Bias Schottky Detectors

MODEL NO.	FREQ. (GHz)	CONNECTOR	Flatness
4802S	2	SMA-M/F	+/- 0.2 dB TYP.
4804S	4	SMA-M/F	+/- 0.2 dB TYP.

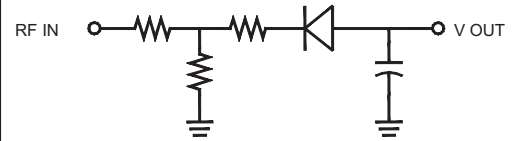

Dust and Moisture Sealing Caps (also available with chain, add suffix "C")

MODEL NO.	CONNECTOR
7602	TNC-M
7603	SMA-M
7604, 7605	N-M, N-F
7606	2.4mm-M
7607	SMP-F

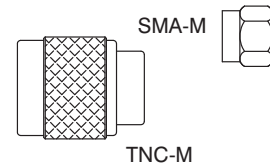

TNC-M

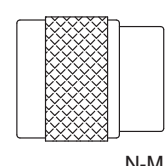

N-M



Ordering / General Information

How to Order

When ordering, state the model number, description of the component and the frequency range as given in the catalog.

You may place your order with the factory, Richardson Electronics, RFMW, or the Aeroflex / Inmet Sales Representative in your area. Factory orders will be accepted by mail, telephone or other electronic communications pending confirmation on your standard purchase order form. Minimum factory order is \$250.00 and subject to change. Quantity minimums may apply for non-standard or special order products.

Address all orders and communications to:
AEROFLEX / INMET INC.
300 Dino Drive
Ann Arbor, MI 48103 USA

Tel.: 888-244-6638 or 734-426-5553
Fax: 734-426-5557
E-mail: inmetsales@aeroflex.com
Web: www.aeroflex.com/inmet
CAGE Code: 64671

Payment Terms

Terms are net 30 days for customers with established credit. All other orders must be prepaid, paid by credit card (VISA, MasterCard and American Express) or C.O.D.

Shipping

All sales are F.O.B. Ann Arbor, Michigan. Unless specified in your order, orders will be shipped "best way" at the company's discretion. Aeroflex / Inmet can only guarantee shipping date. Factory does not assume responsibility for carrier delays and cannot be held responsible for late, lost or damaged shipments. All claims must be filed with the carrier.

Certificate of Compliance

A Certificate of Compliance is shipped with every order. It is located on the reverse side of the packing slip.

Warranty

Aeroflex / Inmet Corporation warrants each product it manufactures to be free from defects in material and workmanship under normal use and service. Aeroflex / Inmet's only obligation under this warranty is to repair or replace, at its factory, any product or part thereof that is returned, with transportation charges prepaid, by the original purchaser within ONE YEAR from the date of shipment.

The foregoing warranty does not apply to, and in Aeroflex / Inmet's sole opinion, products that have been subject to improper or inadequate maintenance, unauthorized modifications, misuse, or operation outside the published specifications for the product.

The warranty stated above is the sole and exclusive warranty and is in lieu of all other warranties, expressed or implied, including, but not limited to, any implied warranty or fitness for any particular purpose. Aeroflex / Inmet shall not be liable for any direct or consequential injury, loss or damage incurred through the use, or inability to use any Aeroflex / Inmet product.

Returns

When returning a component to our factory, a Return Material Authorization (RMA) number must be obtained from Aeroflex / Inmet. When contacting us for an RMA number, please indicate the model number, date of the original purchase, the product lot number and the original invoice number for the purchase. Please also include as much information as possible, including test data, pertaining to the nature of the malfunction or reason for the return and point of contact information for your company.

Cancellations

Orders placed with Inmet may be cancelled only after authorization from Aeroflex / Inmet. Any authorized cancellation is subject to cancellation charges as determined by Aeroflex / Inmet. A component returned for credit will be subject to a restocking charge. If more than 6 months has elapsed since original purchase, the item may not be accepted for credit. Nonstandard components as determined by Aeroflex / Inmet, cannot be returned for credit.

Product Changes

Although all information in this catalog is current at the time of release, Aeroflex / Inmet continuing Product Improvement Program makes it necessary for Aeroflex / Inmet to reserve the right to change specifications without notice.

Quality Assurance

Aeroflex / Inmet's goal is to achieve complete customer satisfaction in the design, quality, delivery, pricing and support of our products. We continue to develop and improve our management systems and manufacturing processes in order to meet this goal.

Aeroflex / Inmet's Quality Assurance system is registered to ISO-9001. Our calibration program for inspection and test equipment complies with the requirements of MIL-STD 45662 and ANSI/NCSLZ540-1.



Certificate No. US-1943



rfwireless.rell.com
or call 800-737-6937
(U. S. & Canada)



www.rfmw.com
or call 877-367-7369



AEROFLEX

300 Dino Drive
Ann Arbor, MI 48103-9457

www.aeroflex.com/inmet

1-888-244-6638 or 734-426-5553



Our passion for performance is defined by three attributes represented by the icons pictured above: solution-minded, performance-driven and customer-focused.

SUNSTAR商斯达实业集团是集研发、生产、工程、销售、代理经销、技术咨询、信息服务等为一体的高科技企业，是专业高科技电子产品生产厂家，是具有10多年历史的专业电子元器件供应商，是中国最早和最大的仓储式连锁规模经营大型综合电子零部件代理分销商之一，是一家专业代理和分销世界各大品牌IC芯片和电子元器件的连锁经营综合性国际公司。在香港、北京、深圳、上海、西安、成都等全国主要电子市场设有直属分公司和产品展示展销窗口门市部专卖店及代理分销商，已在全国范围内建成强大统一的供货和代理分销网络。我们专业代理经销、开发生产电子元器件、集成电路、传感器、微波光电元器件、工控机/DOC/DOM电子盘、专用电路、单片机开发、MCU/DSP/ARM/FPGA软件硬件、二极管、三极管、模块等，是您可靠的一站式现货配套供应商、方案提供商、部件功能模块开发配套商。专业以现代信息产业（计算机、通讯及传感器）三大支柱之一的传感器为主营业务，专业经营各类传感器的代理、销售生产、网络信息、科技图书资料及配套产品设计、工程开发。我们的专业网站——中国传感器科技信息网（全球传感器数据库）www.SENSOR-IC.COM 服务于全球高科技生产商及贸易商，为企业科技产品开发提供技术交流平台。欢迎各厂商互通有无、交换信息、交换链接、发布寻求代理信息。欢迎国外高科技传感器、变送器、执行器、自动控制产品厂商介绍产品到中国，共同开拓市场。本网站是关于各种传感器-变送器-仪器仪表及工业自动化大型专业网站，深入到工业控制、系统工程计 测量、自动化、安防报警、消费电子等众多领域，把最新的传感器-变送器-仪器仪表买卖信息，最新技术供求，最新采购商，行业动态，发展方向，最新的技术应用和市场资讯及时的传递给广大科技开发、科学研究、产品设计人员。本网站已成功为石油、化工、电力、医药、生物、航空、航天、国防、能源、冶金、电子、工业、农业、交通、汽车、矿山、煤炭、纺织、信息、通信、IT、安防、环保、印刷、科研、气象、仪器仪表等领域从事科学研究、产品设计、开发、生产制造的科技人员、管理人员、和采购人员提供满意服务。我们公司专业生产、代理、经销、销售各种传感器、变送器、敏感元器件、开关、执行器、仪器仪表、自动化控制系统：专业从事设计、生产、销售各种传感器、变送器、各种测控仪表、热工仪表、现场控制器、计算机控制系统、数据采集系统、各类环境监控系统、专用控制系统应用软件以及嵌入式系统开发及应用等工作。如热敏电阻、压敏电阻、温度传感器、温度变送器、湿度传感器、湿度变送器、气体传感器、气体变送器、压力传感器、压力变送、称重传感器、物（液）位传感器、物（液）位变送器、流量传感器、流量变送器、电流（压）传感器、溶氧传感器、霍尔传感器、图像传感器、超声波传感器、位移传感器、速度传感器、加速度传感器、扭距传感器、红外传感器、紫外传感器、火焰传感器、激光传感器、振动传感器、轴角传感器、光电传感器、接近传感器、干簧管传感器、继电器传感器、微型电泵、磁敏（阻）传感器、压力开关、接近开关、光电开关、色标传感器、光纤传感器、齿轮测速传感器、时间继电器、计数器、计米器、温控仪、固态继电器、调压模块、电磁铁、电压表、电流表等特殊传感器。同时承接传感器应用电路、产品设计和自动化工程项目。

更多产品请看本公司产品专用销售网站：

商斯达中国传感器科技信息网：<http://www.sensor-ic.com/>

商斯达工控安防网：<http://www.pc-ps.net/>

商斯达电子元器件网：<http://www.sunstare.com/>

商斯达微波光电产品网：[HTTP://www.rfoe.net/](http://www.rfoe.net/)

商斯达消费电子产品网：<http://www.icasic.com/>

商斯达军工产品网：<http://www.junpinic.com/>

商斯达实业科技产品网：<http://www.sunstars.cn/>传感器销售热线：

地址：深圳市福田区福华路福庆街鸿图大厦1602室

电话：0755-83607652 83376489 83376549 83370250 83370251 82500323

传真：0755-83376182 (0) 13902971329 MSN: SUNS888@hotmail.com

邮编：518033 E-mail: szss20@163.com QQ: 195847376

深圳赛格展销部：深圳华强北路赛格电子市场2583号 电话：0755-83665529 25059422

技术支持：0755-83394033 13501568376

欢迎索取免费详细资料、设计指南和光盘；产品凡多，未能尽录，欢迎来电查询。

北京分公司：北京海淀区知春路132号中发电子大厦3097号

TEL: 010-81159046 82615020 13501189838 FAX: 010-62543996

上海分公司：上海市北京东路668号上海赛格电子市场D125号

TEL: 021-28311762 56703037 13701955389 FAX: 021-56703037

西安分公司：西安高新开发区20所(中国电子科技集团导航技术研究所)

西安劳动南路88号电子商城二楼D23号

TEL: 029-81022619 13072977981 FAX:029-88789382