



GaAs MESFET MMIC 1 WATT POWER AMPLIFIER, DC - 6 GHz

Typical Applications

The HMC637LP5(E) wideband PA is ideal for:

- Telecom Infrastructure
- Microwave Radio & VSAT
- Military & Space
- Test Instrumentation
- Fiber Optics

Features

- P1dB Output Power: +29 dBm
- Gain: 13 dB
- Output IP3: +40 dBm
- 50 Ohm Matched Input/Output
- 32 Lead 5x5mm Lead SMT Package: 25mm²

Functional Diagram

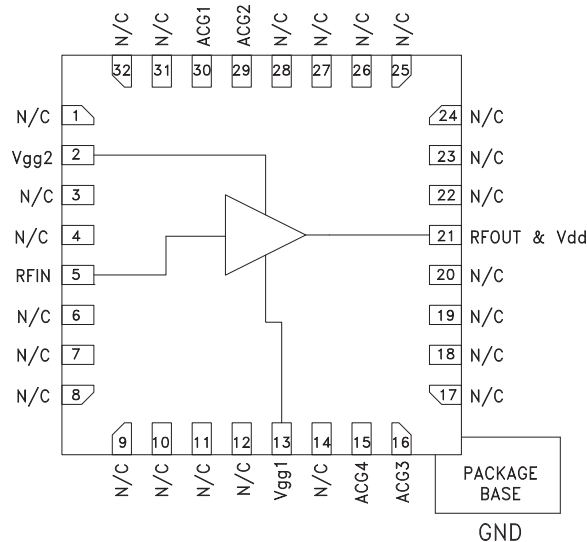

General Description

The HMC637LP5(E) is a GaAs MMIC MESFET Distributed Power Amplifier which operates between DC and 6 GHz. The amplifier provides 13 dB of gain, +40 dBm output IP3 and +29 dBm of output power at 1 dB gain compression while requiring 400 mA from a +12V supply. Gain flatness is excellent at ±0.75 dB from DC - 6 GHz making the HMC637LP5(E) ideal for EW, ECM, Radar and test equipment applications. The HMC637LP5(E) amplifier I/Os are internally matched to 50 ohms and the 5x5 mm QFN package is compatible with high volume SMT assembly equipment.

Electrical Specifications, $T_A = +25^\circ\text{C}$, $V_{dd} = +12\text{V}$, $V_{gg2} = +5\text{V}$, $I_{dd} = 400\text{ mA}^*$

Parameter	Min.	Typ.	Max.	Units
Frequency Range	DC - 6			GHz
Gain	12	13		dB
Gain Flatness		±0.75		dB
Gain Variation Over Temperature		0.025		dB/°C
Input Return Loss		12		dB
Output Return Loss		15		dB
Output Power for 1 dB Compression (P1dB)	27	29		dBm
Saturated Output Power (P _{sat})		29.5		dBm
Output Third Order Intercept (IP3)		40		dBm
Noise Figure		5		dB
Supply Current (I _{dd})	320	400	480	mA

* Adjust V_{gg1} between -2 to 0V to achieve I_{dd} = 400 mA typical.



HMC637LP5 / 637LP5E

GaAs MESFET MMIC 1 WATT POWER AMPLIFIER, DC - 6 GHz

Gain & Return Loss

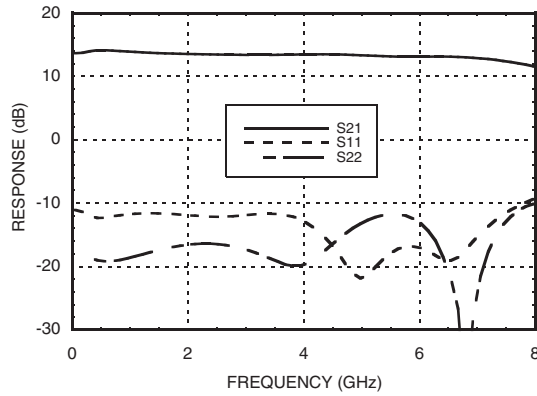

Gain vs. Temperature

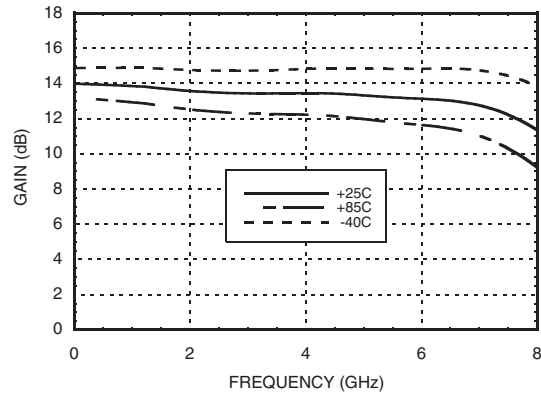

Input Return Loss vs. Temperature

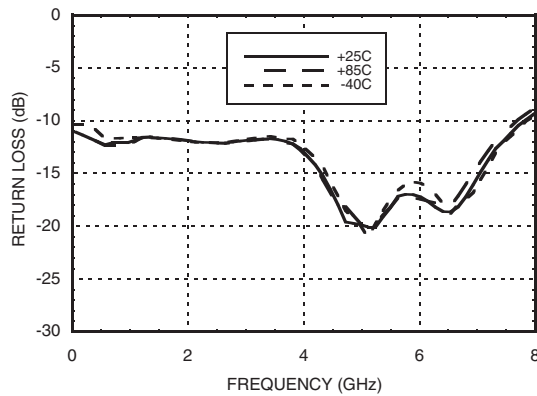

Output Return Loss vs. Temperature

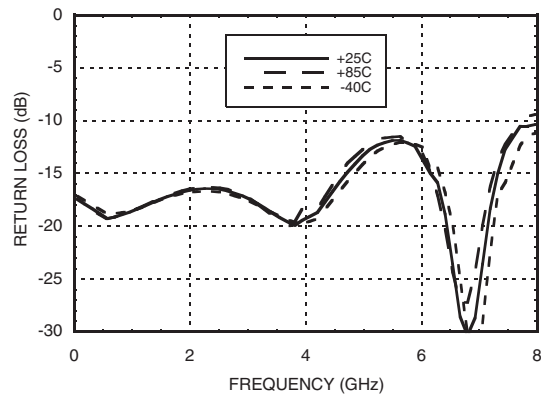

Reverse Isolation vs. Temperature

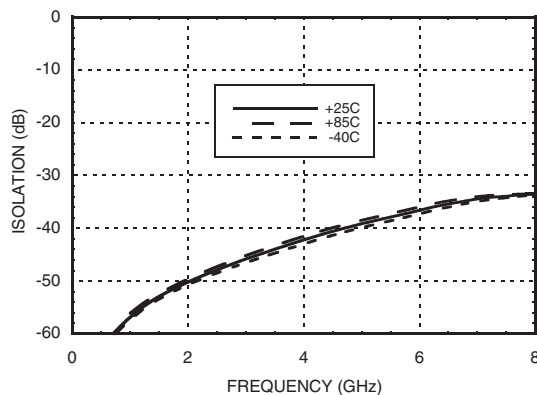

Noise Figure vs. Temperature

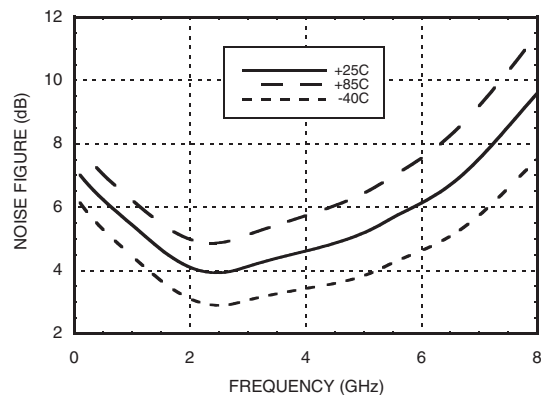



P1dB vs. Temperature

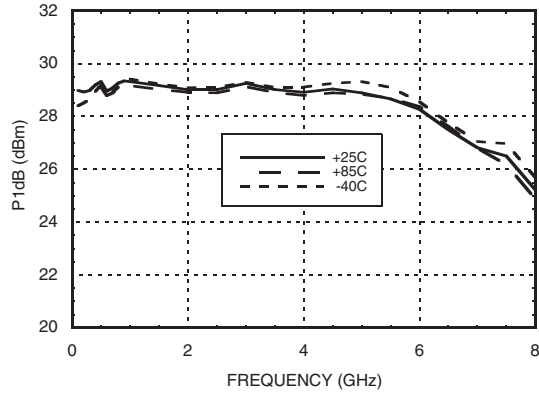

Psat vs. Temperature

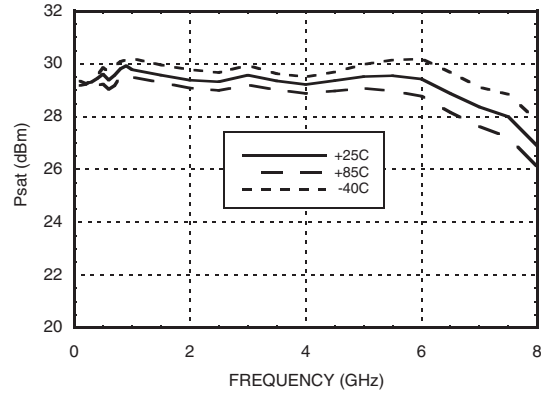

Output IP3 vs. Temperature

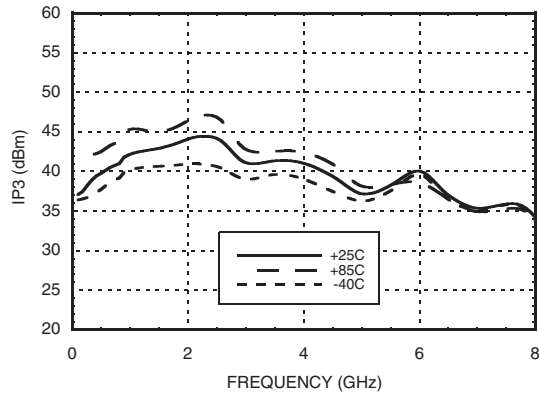

**Gain, Power & Output IP3 vs.
Supply Voltage @ 3 GHz, Fixed Vgg**

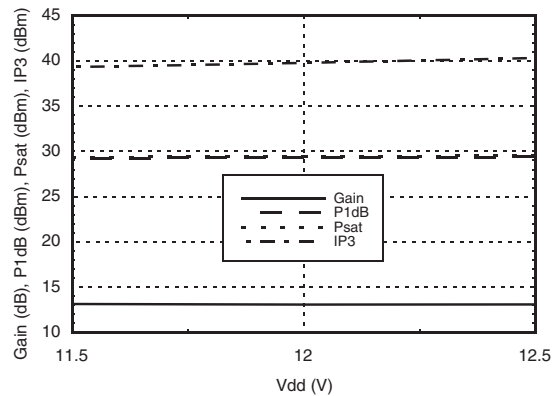

**Gain & Return Loss vs. Frequency,
Log Scale**

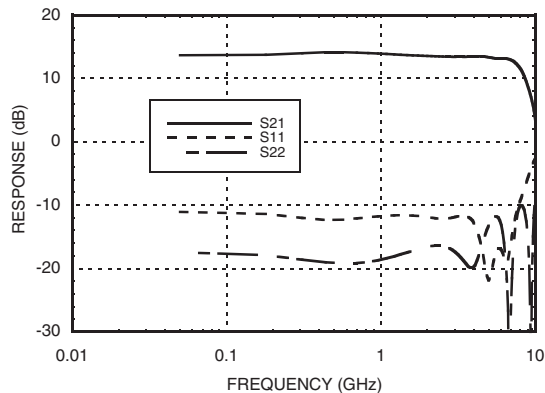

**Output IP3 vs. Temperature,
Log Scale**

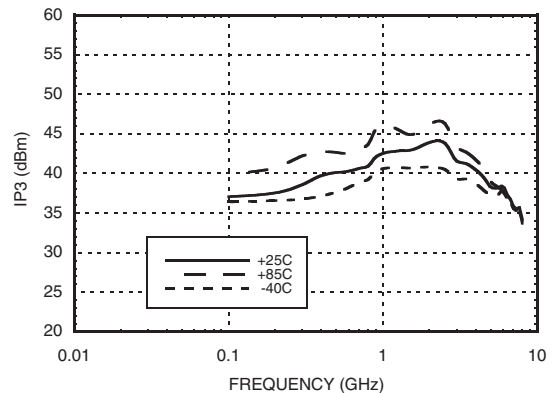



HMC637LP5 / 637LP5E

GaAs MESFET MMIC 1 WATT POWER AMPLIFIER, DC - 6 GHz

Absolute Maximum Ratings

Drain Bias Voltage (Vdd)	+14 Vdc
Gate Bias Voltage (Vgg1)	-3 to 0 Vdc
Gate Bias Voltage (Vgg2)	+4 to +7 Vdc
RF Input Power (RFIN)(Vdd = +12 Vdc)	+25 dBm
Channel Temperature	150 °C
Continuous Pdiss (T= 85 °C) (derate 87 mW/°C above 85 °C)	5.7 W
Thermal Resistance (channel to ground paddle)	11.5 °C/W
Storage Temperature	-65 to 150 °C
Operating Temperature	-40 to 85 °C

Typical Supply Current vs. Vdd

Vdd (V)	Idd (mA)
11.5	373
12.0	400
12.5	425



ELECTROSTATIC SENSITIVE DEVICE
OBSERVE HANDLING PRECAUTIONS

11

LINEAR & POWER AMPLIFIERS - SMT

HMC637LP5 / 637LP5E

**GaAs MESFET MMIC 1 WATT
 POWER AMPLIFIER, DC - 6 GHz**



Outline Drawing

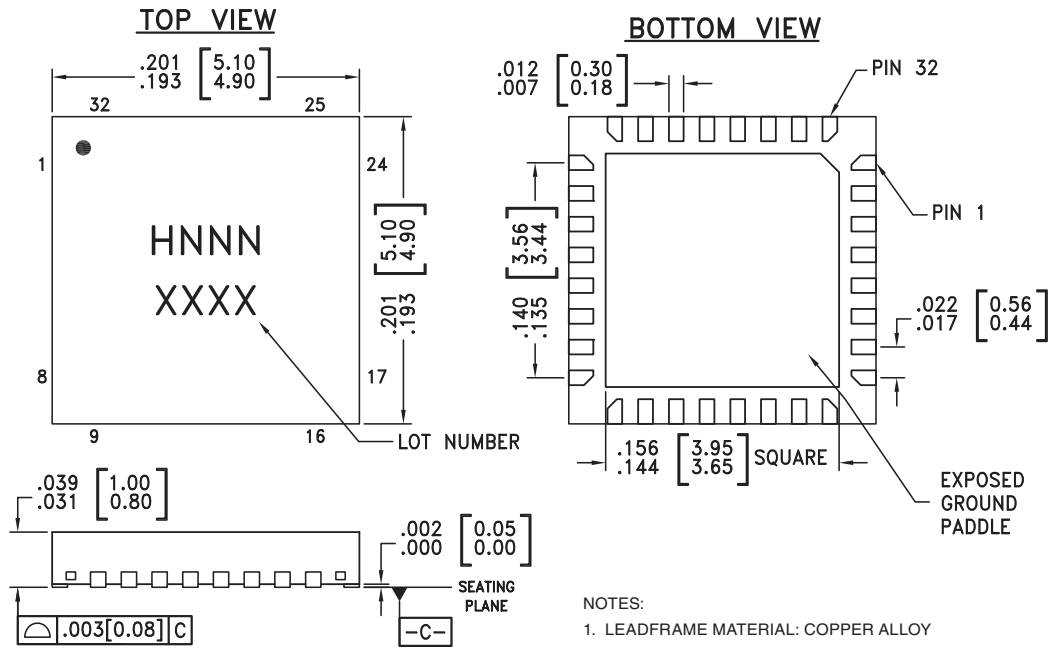

- NOTES:
1. LEADFRAME MATERIAL: COPPER ALLOY
 2. DIMENSIONS ARE IN INCHES [MILLIMETERS]
 3. LEAD SPACING TOLERANCE IS NON-CUMULATIVE
 4. PAD BURR LENGTH SHALL BE 0.15mm MAXIMUM. PAD BURR HEIGHT SHALL BE 0.05mm MAXIMUM.
 5. PACKAGE WARP SHALL NOT EXCEED 0.05mm.
 6. ALL GROUND LEADS AND GROUND PADDLE MUST BE SOLDERED TO PCB RF GROUND.
 7. REFER TO HITTITE APPLICATION NOTE FOR SUGGESTED LAND PATTERN.

Package Information

Part Number	Package Body Material	Lead Finish	MSL Rating	Package Marking ^[3]
HMC637LP5	Low Stress Injection Molded Plastic	Sn/Pb Solder	MSL1 ^[1]	H637 XXXX
HMC637LP5E	RoHS-compliant Low Stress Injection Molded Plastic	100% matte Sn	MSL1 ^[2]	H637 XXXX

[1] Max peak reflow temperature of 235 °C
 [2] Max peak reflow temperature of 260 °C
 [3] 4-Digit lot number XXXX



HMC637LP5 / 637LP5E

GaAs MESFET MMIC 1 WATT POWER AMPLIFIER, DC - 6 GHz

Pin Descriptions

Pin Number	Function	Description	Interface Schematic
1, 3, 4, 6 - 12, 14, 17, 18, 19, 20, 22 - 28, 31, 32	N/C	No connection. These pins may be connected to RF ground. Performance will not be affected.	
2	Vgg2	Gate Control 2 for amplifier. +5V should be applied to Vgg2 for nominal operation. Attach bypass capacitor per application circuit herein.	
5	RFIN	This pad is DC coupled and matched to 50 Ohms.	
13	Vgg1	Gate Control 1 for amplifier. Attach bypass capacitor per application circuit herein. Please follow "MMIC Amplifier Biasing Procedure" Application Note.	
15	ACG4	Low frequency termination. Attach bypass capacitor per application circuit herein.	
16	ACG3		
21	RFOUT & Vdd	RF output for amplifier. Connect the DC bias (Vdd) network to provide drain current (Idd). See application circuit herein.	
29	ACG2	Low frequency termination. Attach bypass capacitor per application circuit herein.	
30	ACG1	Low frequency termination. Attach bypass capacitor per application circuit herein.	
Ground Paddle	GND	Ground paddle must be connected to RF/DC ground.	

11

LINEAR & POWER AMPLIFIERS - SMT



Application Circuit

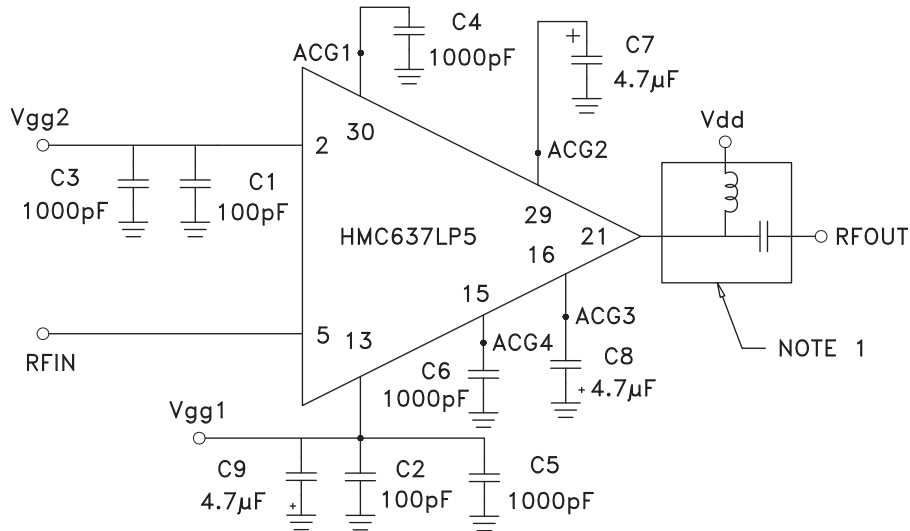

NOTE 1: Drain Bias (Vdd) must be applied through a broadband bias tee or external bias network.

NOTE 2: Power Up Bias Sequence

- A) Set Vgg1 to -2V
- B) Set Vdd to +12V
- C) Set Vgg2 to +5V
- D) Adjust Vgg1 to achieve Idd for 400 mA

Power Down Sequence

- A) Remove Vgg2 Bias
- B) Remove Vdd Bias
- C) Remove Vgg1 Bias

Evaluation PCB

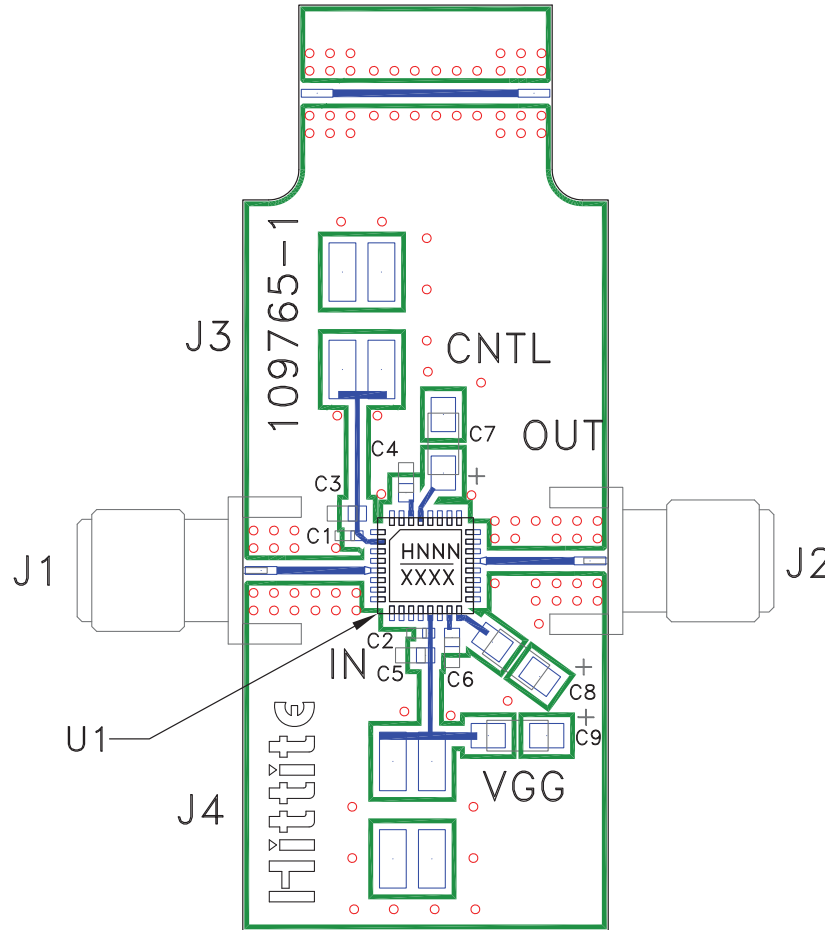

List of Materials for Evaluation PCB 108347 [1]

Item	Description
J1 - J2	SRI SMA Connector
J3 - J4	2mm Molex Header
C1, C2	100 pF Capacitor, 0402 Pkg.
C3 - C6	1000 pF Capacitor, 0603 Pkg.
C7 - C9	4.7 μF Capacitor, Tantalum
U1	HMC637LP5 / HMC637LP5E
PCB [2]	109765 Evaluation PCB

[1] Reference this number when ordering complete evaluation PCB

[2] Circuit Board Material: Rogers 4350

The circuit board used in the final application should use RF circuit design techniques. Signal lines should have 50 ohm impedance while the package ground leads and package bottom should be connected directly to the ground plane similar to that shown. A sufficient number of via holes should be used to connect the top and bottom ground planes. The evaluation board should be mounted to an appropriate heat sink. The evaluation circuit board shown is available from Hittite upon request.