



## WIDEBAND MMIC VCO w/ BUFFER AMPLIFIER, 8.0 - 12.5 GHz

### Typical Applications

Low Noise wideband MMIC VCO is ideal for:

- Industrial/Medical Equipment
- Test & Measurement Equipment
- Military Radar, EW & ECM

### Features

- Wide Tuning Bandwidth
- Pout: +5 dBm
- Low SSB Phase Noise: -93 dBc/Hz @100 kHz
- No External Resonator Needed
- Single Positive Supply: +5V @ 55 mA
- RoHS Compliant 4 x 4 mm SMT Package

### Functional Diagram

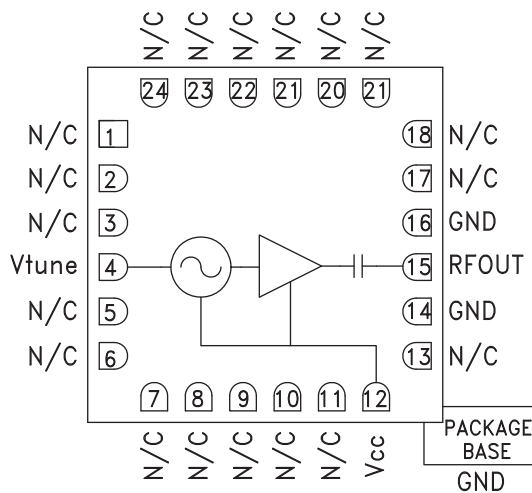

### General Description

The HMC588LC4B is a wideband GaAs InGaP HBT MMIC Voltage Controlled Oscillator which incorporates the resonator, negative resistance device, and varactor diode. Output power and phase noise performance are excellent over temperature due to the oscillator's monolithic construction. The Vtune port accepts an analog tuning voltage from 0 to +13V. The HMC588LC4B VCO operates from a single +5V supply, consumes only 55 mA of current, and is housed in a RoHS compliant SMT package. This wideband VCO uniquely combines the attributes of ultra small size, low phase noise, low power consumption, and wide tuning range.

### Electrical Specifications, $T_A = +25^\circ C$ , $V_{CC} = +5V$

Parameter	Min.	Typ.	Max.	Units
Frequency Range	8.0 - 12.5			GHz
Power Output	2	5		dBm
SSB Phase Noise @ 100 kHz Offset		-93		dBc/Hz
SSB Phase Noise @ 10 kHz Offset		-65		dBc/Hz
Tune Voltage (Vtune)	0		13	V
Supply Current (Icc) (Vcc = +5.0V)	40		75	mA
Tune Port Leakage Current (Vtune = +13V)			10	µA
Output Return Loss		7		dB
2nd Harmonic		-18		dBc
Pulling (into a 2.0:1 VSWR)		4		MHz pp
Pushing @ Vtune = +5V		100		MHz/V
Frequency Drift Rate		0.3		MHz/°C

For price, delivery, and to place orders, please contact Hittite Microwave Corporation:

SUNSTAR 微波光电 <http://www.hittite.com> TEL:0755-83396822 FAX:0755-83376182 E-MAIL: szss20@163.com

Order On-line at [www.hittite.com](http://www.hittite.com)



## HMC588LC4B

### WIDEBAND MMIC VCO w/ BUFFER AMPLIFIER, 8.0 - 12.5 GHz

Frequency vs. Tuning Voltage,  $V_{cc} = +5V$

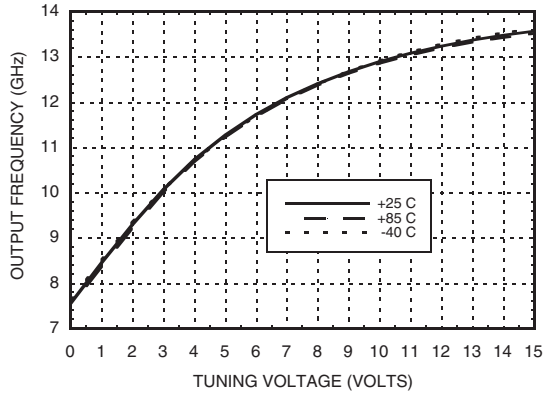

Frequency vs. Tuning Voltage,  $T = +25 C$

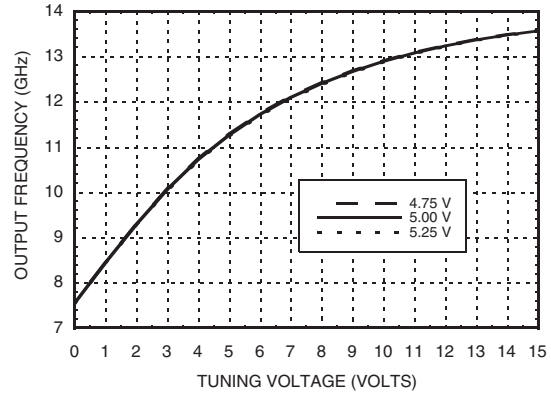

Sensitivity vs. Tuning Voltage,  $V_{cc} = +5V$

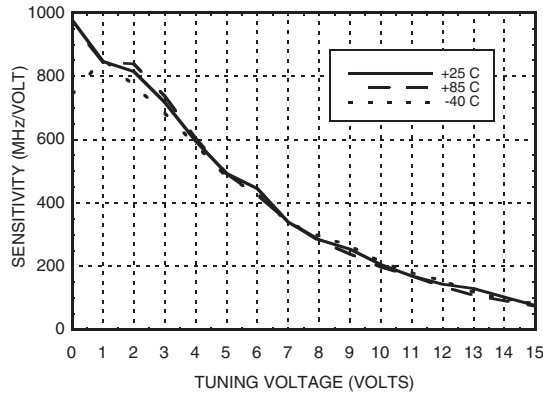

Output Power vs.  
Tuning Voltage,  $V_{cc} = +5V$

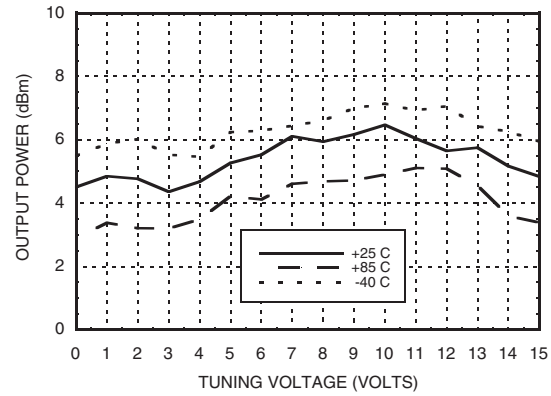

SSB Phase Noise vs. Tuning Voltage

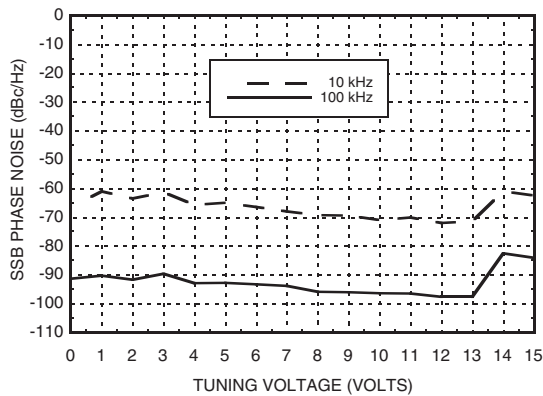

Typical SSB Phase Noise @  $V_{tune} = +5V$

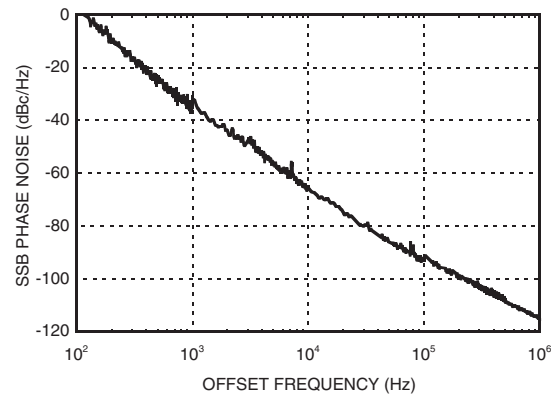



## WIDEBAND MMIC VCO w/ BUFFER AMPLIFIER, 8.0 - 12.5 GHz

### Absolute Maximum Ratings

Vcc	+5.5 Vdc
Vtune	0 to +15V
Junction Temperature	135 °C
Continuous Pdiss (T = 85°C) (derate 10.5 mW/°C above 85°C)	526 mW
Thermal Resistance (junction to ground paddle)	95 °C/W
Storage Temperature	-65 to +150 °C
Operating Temperature	-40 to +85 °C
ESD Sensitivity (HBM)	Class 1A



ELECTROSTATIC SENSITIVE DEVICE  
OBSERVE HANDLING PRECAUTIONS

### Outline Drawing

### BOTTOM VIEW

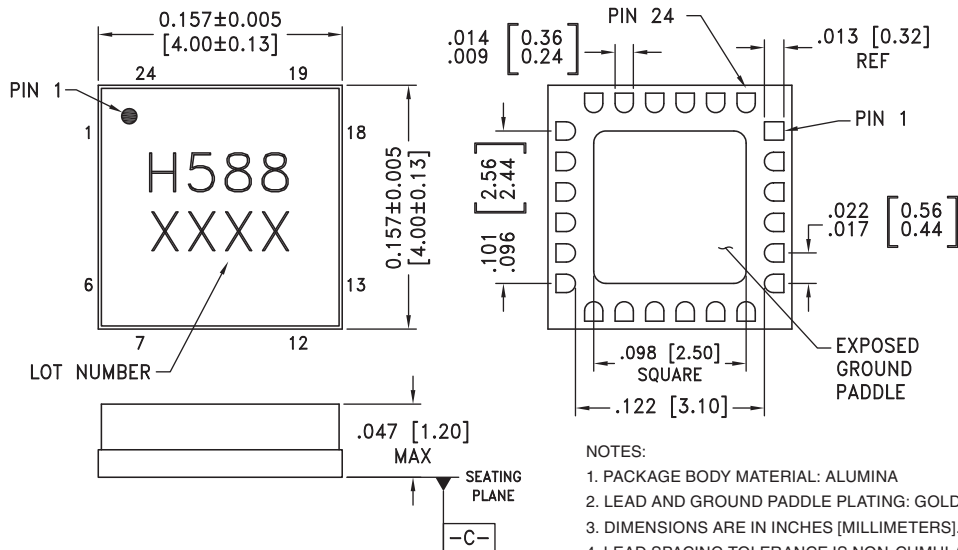

#### NOTES:

1. PACKAGE BODY MATERIAL: ALUMINA
2. LEAD AND GROUND PADDLE PLATING: GOLD FLASH OVER NI.
3. DIMENSIONS ARE IN INCHES [MILLIMETERS].
4. LEAD SPACING TOLERANCE IS NON-CUMULATIVE.
5. PACKAGE WARP SHALL NOT EXCEED 0.05mm DATUM -C-
6. ALL GROUND LEADS AND GROUND PADDLE MUST BE SOLDERED TO PCB RF GROUND.

### Pin Descriptions

Pin Number	Function	Description	Interface Schematic
1 - 3, 5 - 11, 13, 17 - 24	N/C	No Connection. These pins may be connected to RF/DC ground. Performance will not be affected.	
4	Vtune	Control Voltage and Modulation Input. Modulation bandwidth dependent on drive source impedance. See "Determining the FM Bandwidth of a Wideband Varactor Tuned VCO" application note.	
12	Vcc	Supply Voltage Vcc= +5V	

For price, delivery, and to place orders, please contact Hittite Microwave Corporation:

SUNSTAR 微波光电 <http://www.hittite.com> / TEL:0755-83396822 FAX:0755-83376182 E-MAIL: szss20@163.com  
Order On-line at [www.hittite.com](http://www.hittite.com)



## WIDEBAND MMIC VCO w/ BUFFER AMPLIFIER, 8.0 - 12.5 GHz

### Pin Descriptions

Pin Number	Function	Description	Interface Schematic
14, 16	GND	Package bottom has an exposed metal paddle that must also be RF & DC grounded.	
15	RFOUT	RF output (AC coupled)	

### Evaluation PCB

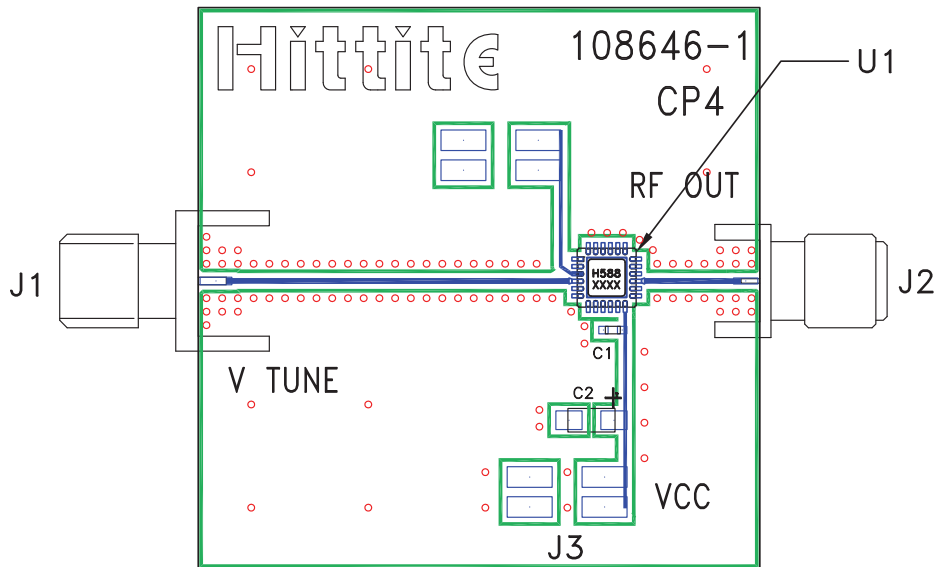

### List of Materials for Evaluation PCB 108648 [1]

Item	Description
J1	PCB Mount SMA RF Connector, Johnson
J2	PCB Mount SMA Connector, SRI
J3	DC Header
C1	1000 pF Capacitor, 0402 Pkg.
C2	4.7 μF Capacitor, Tantalum
U1	HMC588LC4B VCO
PCB [2]	108646 Eval Board

[1] Reference this number when ordering complete evaluation PCB

[2] Circuit Board Material: Rogers 4350

The circuit board used in the final application should use RF circuit design techniques. Signal lines should have 50 ohm impedance while the package ground leads and exposed ground paddle should be connected directly to the ground plane similar to that shown. A sufficient number of via holes should be used to connect the top and bottom ground planes. The evaluation circuit board shown is available from Hittite upon request.