2-Wire Chopper Stabilized Hall Effect Switches

Discontinued Product

These parts are no longer in production. The device should not be purchased for new design applications. Samples are no longer available.

Date of status change: May 1, 2006

Recommended Substitutions:

For existing customer transition, and for new customers or new applications, refer to the [A1142](#) and [A1143](#).

NOTE: For detailed information on purchasing options, contact your local Allegro field applications engineer or sales representative.

Allegro MicroSystems, Inc. reserves the right to make, from time to time, revisions to the anticipated product life cycle plan for a product to accommodate changes in production capabilities, alternative product availabilities, or market demand. The information included herein is believed to be accurate and reliable. However, Allegro MicroSystems, Inc. assumes no responsibility for its use; nor for any infringements of patents or other rights of third parties which may result from its use.

3361 AND 3362

2-WIRE, CHOPPER-STABILIZED, HALL-EFFECT SWITCHES

Suffix Code 'LH' Pinning (SOT23W)

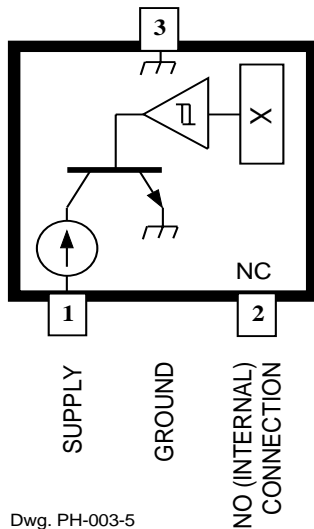

Pinning is shown viewed from branded side.

ABSOLUTE MAXIMUM RATINGS at $T_A=+25^\circ\text{C}$

Supply Voltage, V_{CC}	26.5 V
Reverse Battery Voltage, V_{RCC}	-16 V
Magnetic Flux Density, B	Unlimited
Package Power Dissipation, P_D . See Graph	
Junction Temperature, T_J	+170°C
Operating Temperature Range,	
T_A	-40°C to +85°C
Storage Temperature Range,	
T_S	-65°C to +170°C

The A3361x and A3362x Hall-effect switches are extremely temperature-stable and stress-resistant sensors. Superior performance over temperature is made possible through dynamic offset cancellation, which reduces the residual offset voltage normally caused by device overmolding, temperature dependencies, and thermal stress. The two devices differ only in output polarity; the A3361x output current goes low in the presence of a south pole of sufficient strength; the A3362x output current goes high.

Each device includes on a single silicon chip a voltage regulator, Hall-voltage generator, small-signal amplifier, chopper stabilization, Schmitt trigger, and a constant-current open-collector output. An on-board regulator permits operation with supply voltages of 3.5 to 24 volts. Noise radiation is limited by control of the output current slew rate.

Three package styles provide a magnetically optimized package for most applications. Suffix 'xLH' is a miniature SOT23W low-profile surface-mount package, and suffix 'xUA' is a three-lead ultra-mini SIP for through-hole mounting.

FEATURES

- Internal Current Regulator for 2-Wire Operation
- Resistant to Physical Stress
- Superior Temperature Stability
- Operation From Unregulated Supply
- Solid-State Reliability
- Small Size

Always order by complete part number: the prefix 'A' + the basic four-digit part number + a suffix to indicate operating temperature range (E) + a two-letter suffix to indicate package style, e.g., **A3361ELH**.

3361 AND 3362
2-WIRE,
CHOPPER-STABILIZED,
HALL-EFFECT SWITCHES

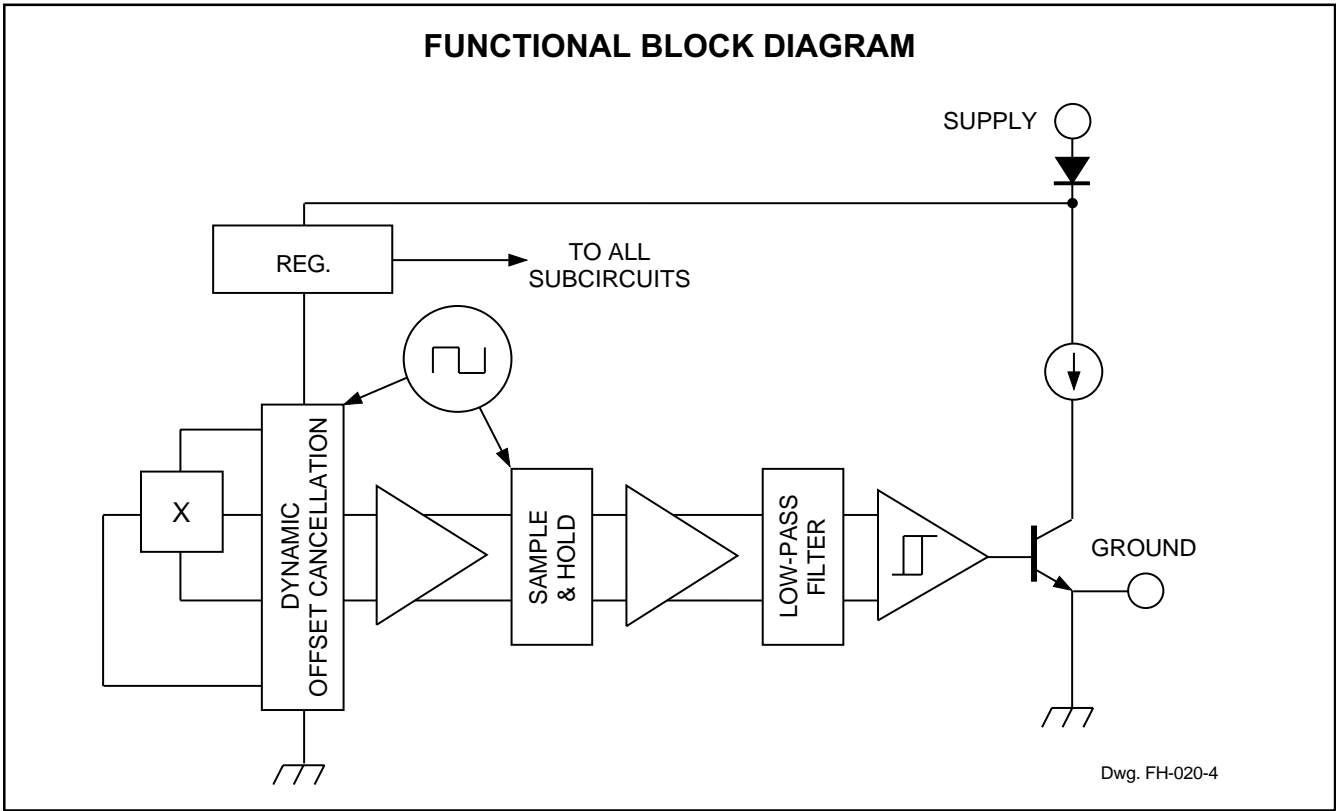

Suffix Code 'UA' Pinning
 (ultra-mini SIP)

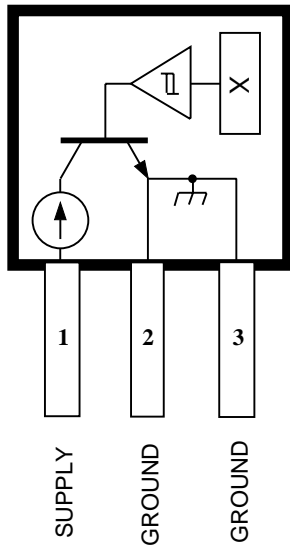

Dwg. PH-003-7A

Pinning is shown viewed from branded side.

3361 AND 3362 2-WIRE, CHOPPER-STABILIZED, HALL-EFFECT SWITCHES

ELECTRICAL CHARACTERISTICS over operating temperature range.

Characteristic	Symbol	Test Conditions	Limits			
			Min.	Typ.	Max.	Units
Supply Voltage	V_{CC}	Operating	3.5	12	24	V
Output Current	$I_{GND(L)}$	Output Current Low	5.0	–	6.9	mA
	$I_{GND(H)}$	Output Current High	12	–	17	mA
Chopping Frequency	f_C		–	340	–	kHz
Output Settling Time	t_{sd}	$C_L = 20$ pF	–	–	50	μ s
Output Rise Time	t_r	$C_L = 20$ pF	–	3.5	–	μ s
Output Fall Time	t_f	$C_L = 20$ pF	–	3.5	–	μ s
Reverse Battery Current	I_{CC}	$V_{RCC} = -16$ V	–	–	-15	mA

NOTE: Typical Data is at $T_A = +25^\circ\text{C}$ and $V_{CC} = 12$ V and is for design information only.

A3361 MAGNETIC CHARACTERISTICS over operating supply voltage and temperature ranges.

Characteristic	Symbol	Test Conditions	Limits			
			Min.	Typ.	Max.	Units
Operate Point	B_{OP}	$B > B_{OP}$, $I_{GND} = \text{LOW}$	–	–	125	G
Release Point	B_{RP}	$B < B_{RP}$, $I_{GND} = \text{HIGH}$	40	–	–	G
Hysteresis	B_{hys}	$B_{OP} - B_{RP}$	5.0	–	30	G

A3362 MAGNETIC CHARACTERISTICS over operating supply voltage and temperature ranges.

Characteristic	Symbol	Test Conditions	Limits			
			Min.	Typ.	Max.	Units
Operate Point	B_{OP}	$B > B_{OP}$, $I_{GND} = \text{HIGH}$	–	–	125	G
Release Point	B_{RP}	$B < B_{RP}$, $I_{GND} = \text{LOW}$	40	–	–	G
Hysteresis	B_{hys}	$B_{OP} - B_{RP}$	5.0	–	30	G

NOTE: 1 gauss is exactly equal to 0.1 millitesla (mt).

3361 AND 3362
2-WIRE,
CHOPPER-STABILIZED,
HALL-EFFECT SWITCHES

OUTPUT CHARACTERISTICS

A3361x

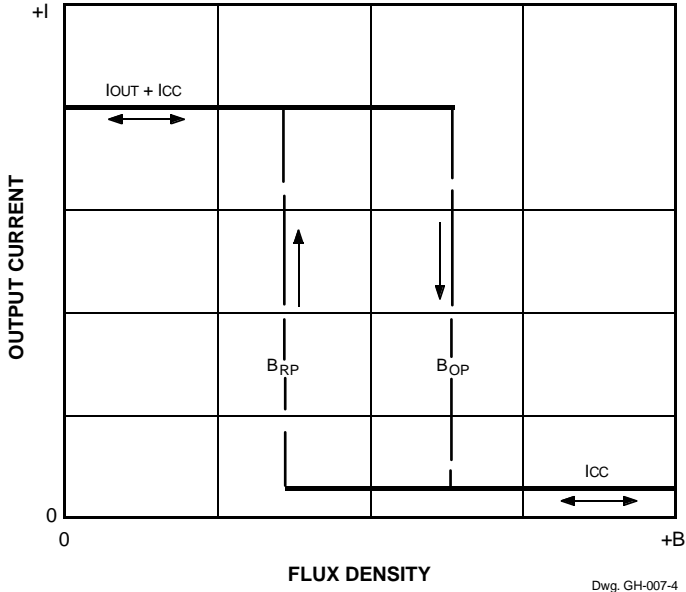

A3362x

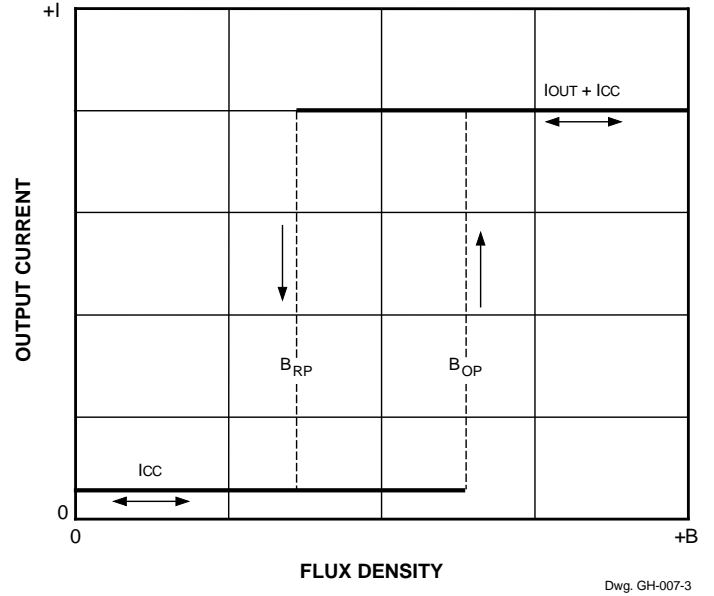

3361 AND 3362 2-WIRE, CHOPPER-STABILIZED, HALL-EFFECT SWITCHES

SENSOR LOCATIONS

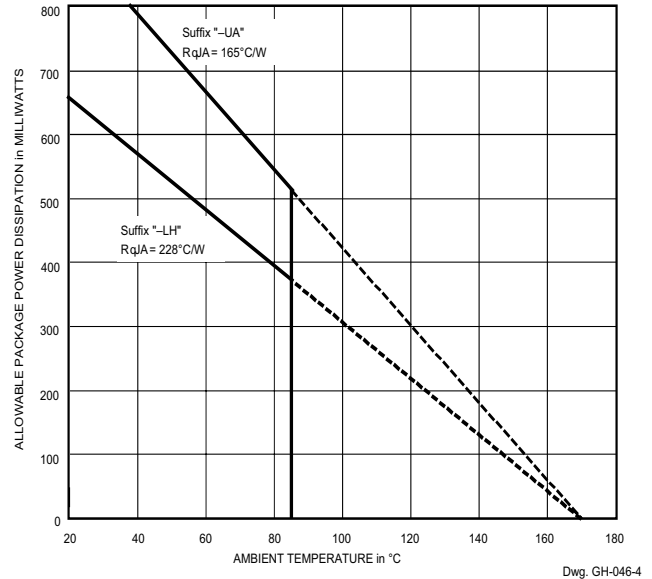
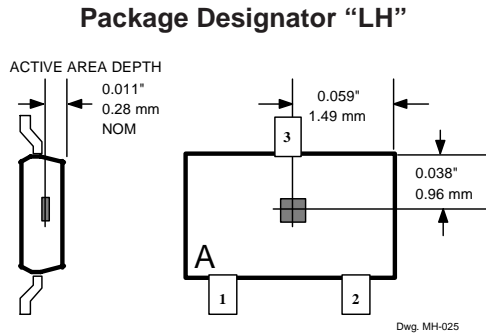

APPLICATIONS INFORMATION

Package Designators "UA"

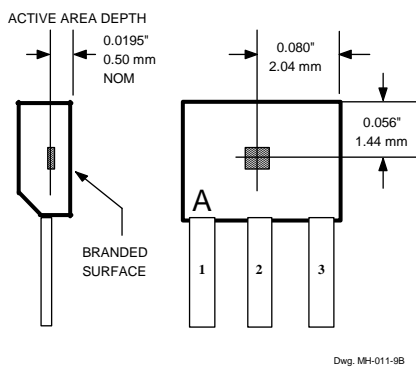

Although sensor location is accurate to three sigma for a particular design, product improvements may result in small changes to sensor location.

Extensive applications information for Hall-effect sensors is available in:

- *Hall-Effect IC Applications Guide*, Application Note 27701;
- *Hall-Effect Devices: Soldering, Gluing, Potting, Encapsulating, and Lead Forming*, Application Note 27703.1;
- *Soldering of Through-Hole Hall-Sensor Devices*, Application Note 27703;
- *Soldering of Surface-Mount Hall-Sensor Devices*, Application Note 27703.2.

More detailed descriptions of the chopper-stabilized circuit operation can be found in:

- *Monolithic Magnetic Hall Sensor Using Dynamic Quadrature Offset Cancellation*, Technical Paper STP 97-10; and
- *Chopper-Stabilized Amplifiers With A Track-and-Hold Signal Demodulator*, Technical Paper STP 99-1.

All are provided at

www.allegromicro.com

3361 AND 3362

2-WIRE, CHOPPER-STABILIZED, HALL-EFFECT SWITCHES

FUNCTIONAL DESCRIPTION

Chopper-Stabilized Technique. The Hall element can be considered as a resistor array similar to a Wheatstone bridge. A large portion of the offset is a result of the mismatching of these resistors. These devices use a proprietary dynamic offset cancellation technique, with an internal high-frequency clock to reduce the residual offset voltage of the Hall element that is normally caused by device overmolding, temperature dependencies, and thermal stress. The chopper-stabilizing technique cancels the mismatching of the resistor circuit by changing the direction of the current flowing through the Hall plate using CMOS switches and Hall voltage measurement taps, while maintaining the Hall-voltage signal that is induced by the external magnetic flux. The signal is then captured by a sample-and-hold circuit and further processed using low-offset bipolar circuitry. This technique produces devices that have an extremely stable quiescent Hall output voltage, are immune to thermal stress, and have precise recoverability after temperature cycling. This technique will also slightly degrade the device output repeatability. A relatively high sampling frequency is used in order that faster signals can be processed.

Operation. As shown in the output characteristic graphs, the output of the A3362 turns on when a magnetic field (south pole) perpendicular to the Hall sensor is increased above the operate point threshold (B_{OP}). After turn on, the output will source current equal to the device operating current plus a current source ($I_{GND(H)}$). When the magnetic field is decreased below the release point (B_{RP}), the output turns off and will source current equal only to the Hall-effect sensor operating current ($I_{GND(L)}$). The A3361 output is inverted and the device turns off at B_{OP} and on at B_{RP} . The difference in the magnetic operate and release points is the hysteresis (B_{hys}) of the device. The hysteresis allows clean switching of the output even in the presence of external mechanical vibration or electrical noise.

Applications. It is strongly recommended that an external bypass capacitor be connected (in close proximity to the Hall sensor) between the supply and ground of the device to reduce both external noise and noise generated by the chopper-stabilization technique.

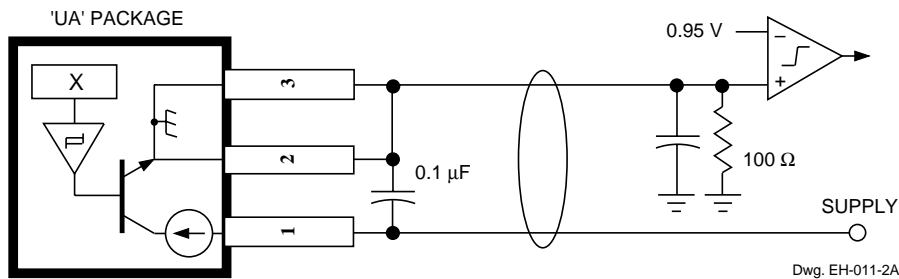
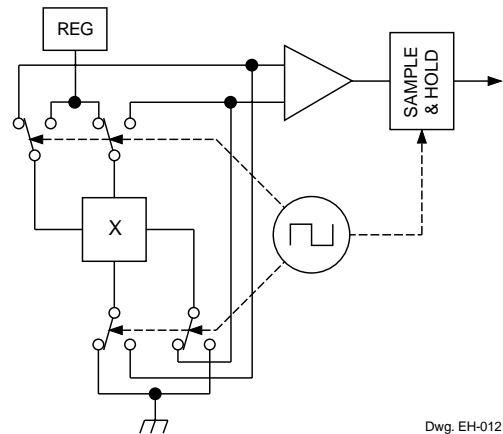
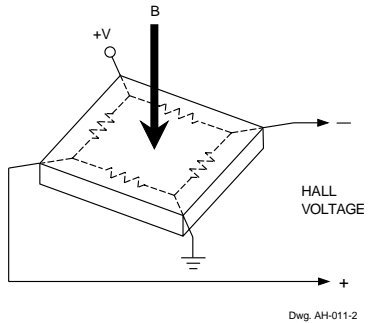

3361 AND 3362 2-WIRE, CHOPPER-STABILIZED, HALL-EFFECT SWITCHES

Operating Characteristics

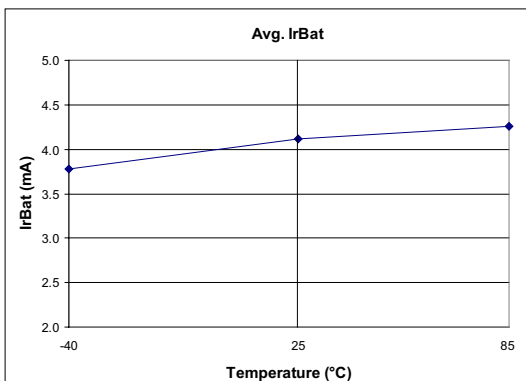
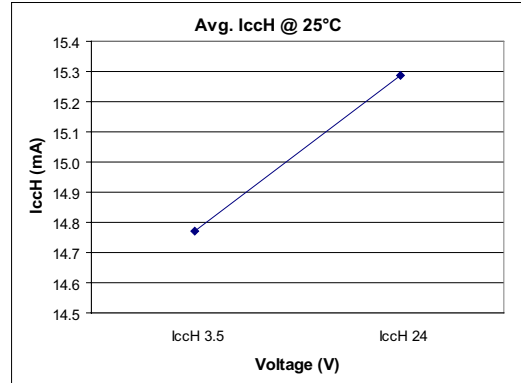
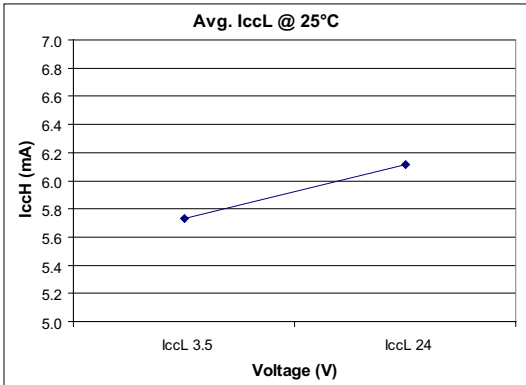
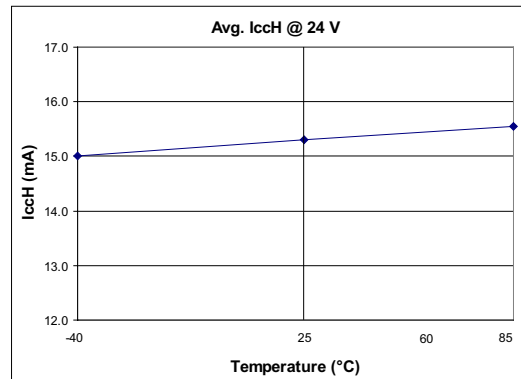
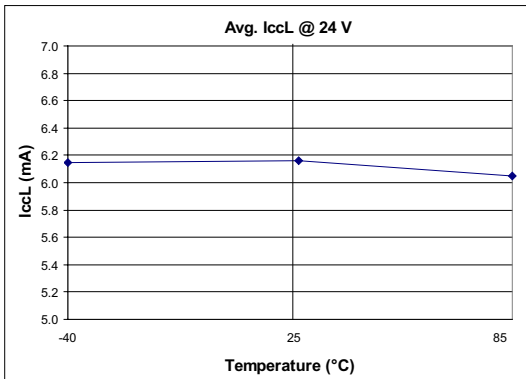
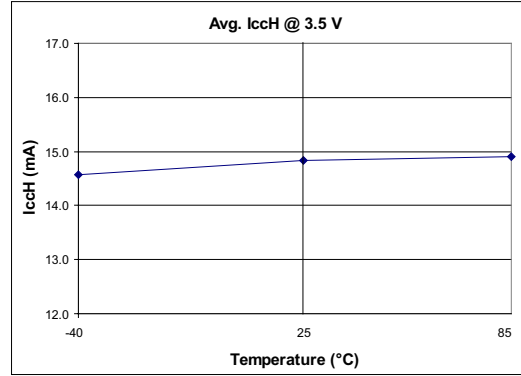
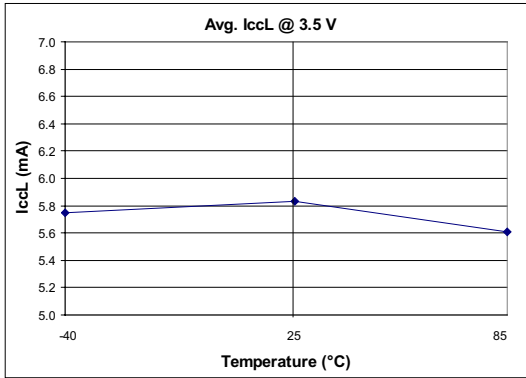

3361 AND 3362

2-WIRE, CHOPPER-STABILIZED, HALL-EFFECT SWITCHES

Operating Characteristics

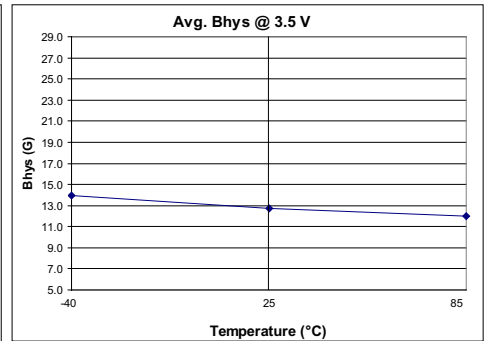
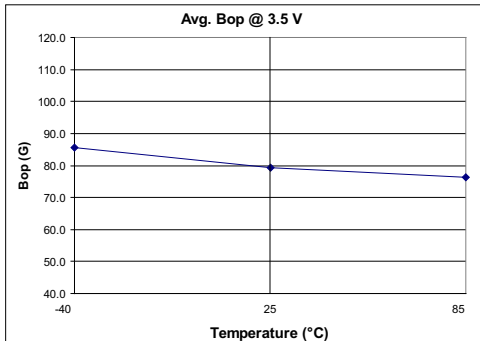
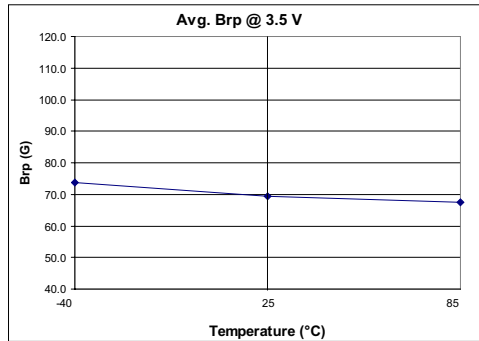
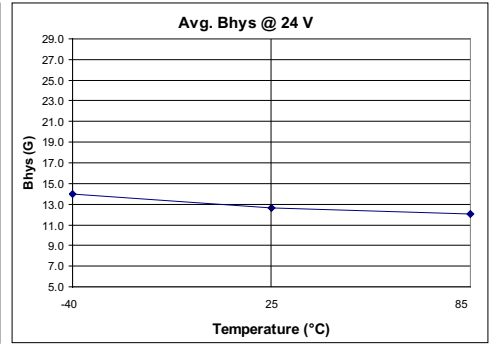
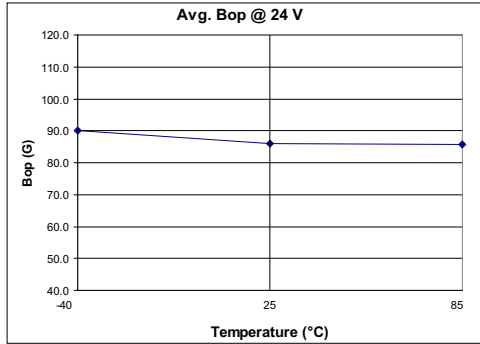
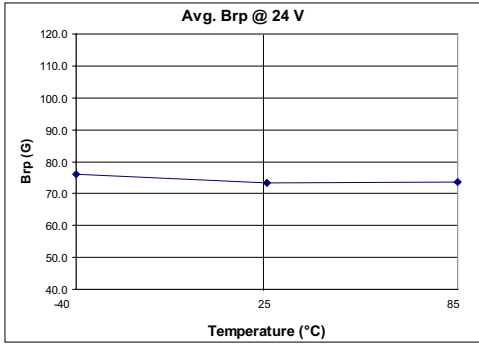
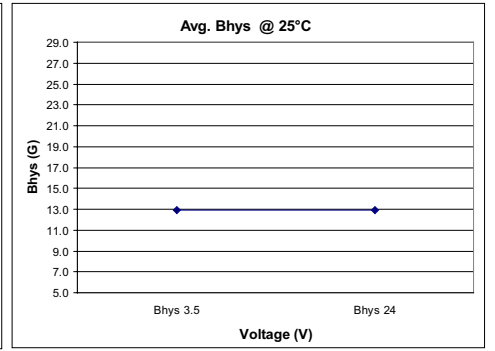
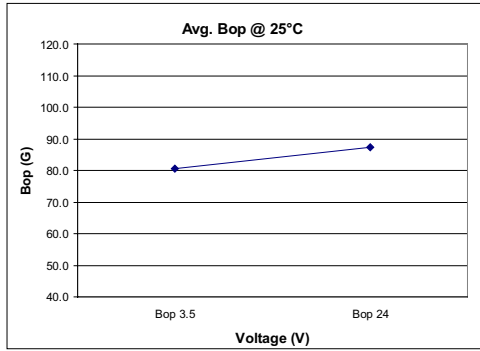
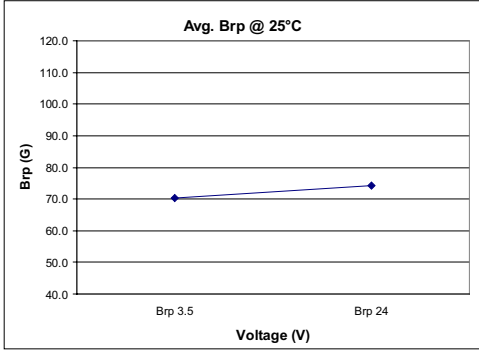

3361 AND 3362 2-WIRE, CHOPPER-STABILIZED, HALL-EFFECT SWITCHES

PACKAGE DESIGNATOR 'LH'

(fits SC-59A solder-pad layout)

Dimensions in Inches
(for reference only)

Dimensions in Millimeters
(controlling dimensions)

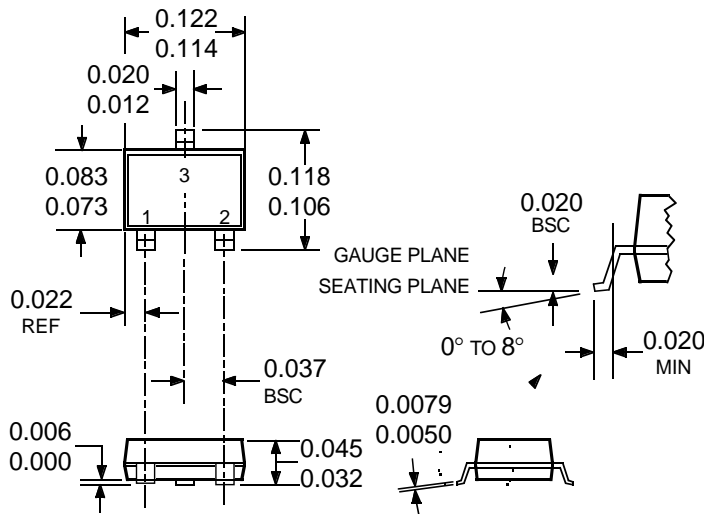

Dwg. MA-010-3C in

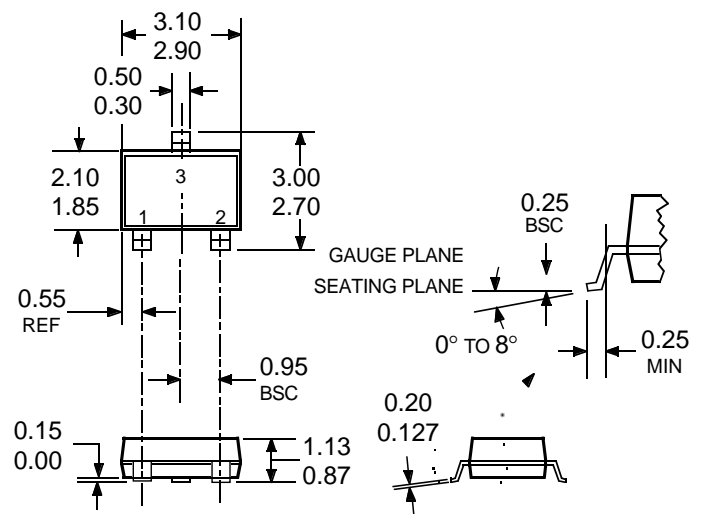

Dwg. MA-010-3C mm

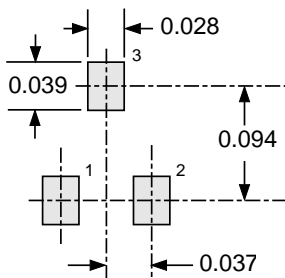

Dwg. MA-011-3 in

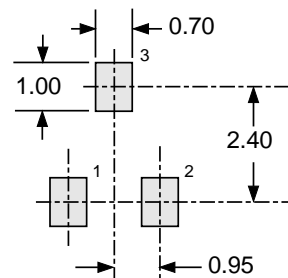

Dwg. MA-011-3 mm

- NOTES: 1. Tolerances on package height and width represent allowable mold offsets. Dimensions given are measured at the widest point (parting line).
 2. Exact body and lead configuration at vendor's option within limits shown.
 3. Height does not include mold gate flash.
 4. Where no tolerance is specified, dimension is nominal.
 5. Add "TR" to part number for tape and reel.

3361 AND 3362 2-WIRE, CHOPPER-STABILIZED, HALL-EFFECT SWITCHES

PACKAGE DESIGNATOR 'UA'

Dimensions in Inches
(controlling dimensions)

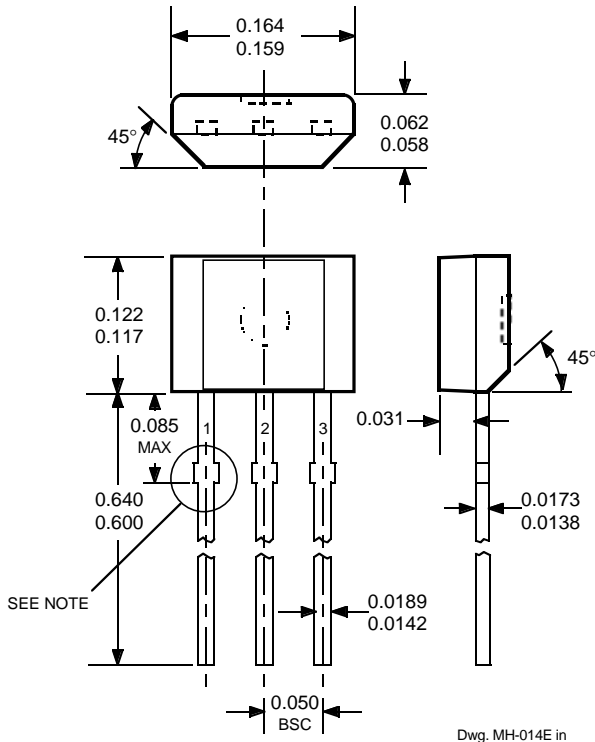

Dimensions in Millimeters
(for reference only)

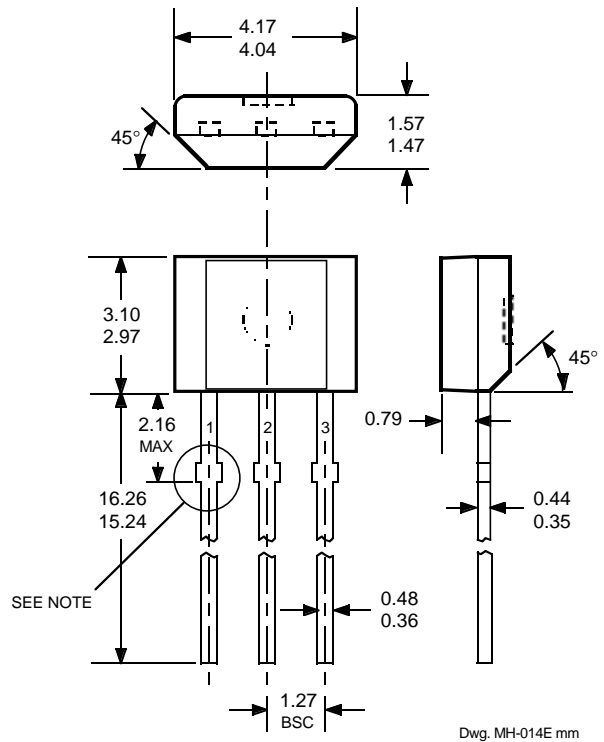

- NOTES: 1. Tolerances on package height and width represent allowable mold offsets. Dimensions given are measured at the widest point (parting line).
2. Exact body and lead configuration at vendor's option within limits shown.
3. Height does not include mold gate flash.
4. Recommended minimum PWB hole diameter to clear transition area is 0.035" (0.89 mm).
5. Where no tolerance is specified, dimension is nominal.
6. Supplied in bulk pack (500 pieces per bag).

Radial Lead Form (order A326xEUA-LC)

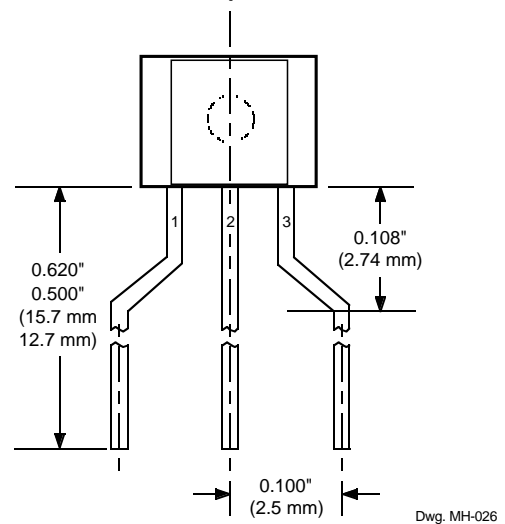

NOTE: Lead-form dimensions are the nominals produced on the forming equipment. No dimensional tolerance is implied or guaranteed for bulk packaging (500 pieces per bag).

3361 AND 3362
2-WIRE,
CHOPPER-STABILIZED,
HALL-EFFECT SWITCHES

The products described herein are manufactured under one or more of the following U.S. patents: 5,045,920; 5,264,783; 5,442,283; 5,389,889; 5,581,179; 5,517,112; 5,619,137; 5,621,319; 5,650,719; 5,686,894; 5,694,038; 5,729,130; 5,917,320; and other patents pending.

Allegro MicroSystems, Inc. reserves the right to make, from time to time, such departures from the detail specifications as may be required to permit improvements in the performance, reliability, or manufacturability of its products. Before placing an order, the user is cautioned to verify that the information being relied upon is current.

Allegro products are not authorized for use as critical components in life-support appliances, devices, or systems without express written approval.

The information included herein is believed to be accurate and reliable. However, Allegro MicroSystems, Inc. assumes no responsibility for its use; nor for any infringements of patents or other rights of third parties that may result from its use.