

Infrared Emitting Diodes(GaAs)

KODENSHI

EL - 23G

The EL - 23G, a high - power GaAs IRED mounted in a clear sidelooking package, is compact, low profile, and easy to mount.

FEATURES

- Compact
- Low profile package
- Low - cost
- Sidelooking plastic package

APPLICATIONS

- Photointerrupters
- Optical switches
- Toys

DIMENSIONS

(Unit : mm)

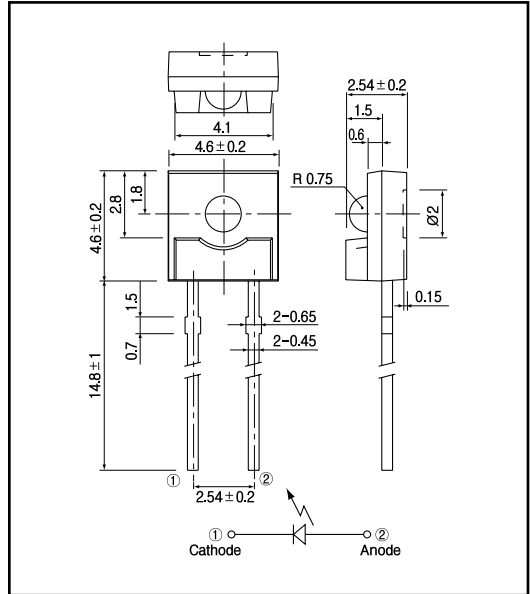

MAXIMUM RATINGS

(Ta=25)

Item	Symbol	Rating	Unit
Reverse voltage	V_R	5	V
Forward current	I_F	60	mA
Pulse forward current ^{*1}	I_{FP}	1	A
Power dissipation	P_D	100	mW
Operating temp.	$T_{opr.}$	- 20 ~ + 100	
Storage temp.	$T_{stg.}$	- 30 ~ + 100	
Soldering temp. ^{*2}	$T_{sol.}$	240	

*1. pulse width : t_w 100 μ sec.period : T=10msec.

*2. For MAX.5 seconds at the position of 2 mm from the package

ELECTRO-OPTICAL CHARACTERISTICS

(Ta=25)

Item	Symbol	Conditions	Min.	Typ.	Max.	Unit.
Forward voltage	V_F	$I_F=60mA$		1.3	1.6	V
Reverse current	I_R	$V_R=5V$			10	μ A
Capacitance	C_t	$f=1MHz$		25		pF
Radiant intensity	P_D	$I_F=60mA$		2.0		mW/sr
Peak emission wavelength	λ_p	$I_F=60mA$		940		nm
Spectral bandwidth 50%		$I_F=60mA$		50		nm
Half angle				± 30		deg.

Infrared Emitting Diodes(GaAs)

EL - 23G

Power dissipation Vs. Ambient temperature

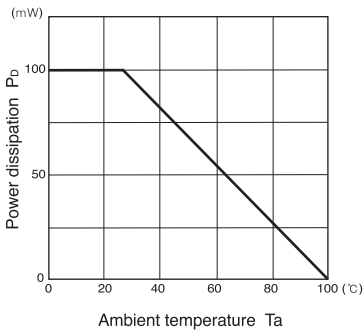

Radiant intensity Vs. Forward current

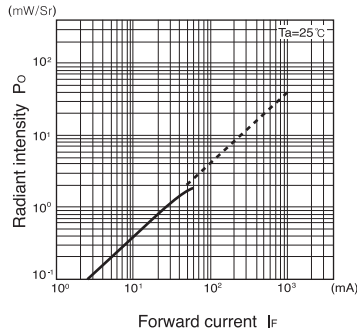

Relative radiant intensity Vs. Ambient temperature

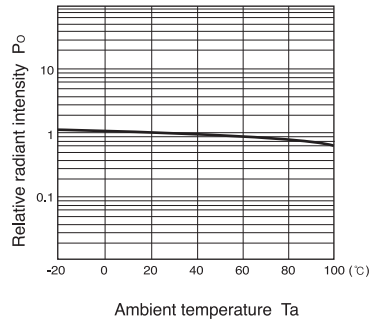

Relative intensity Vs. Wavelength

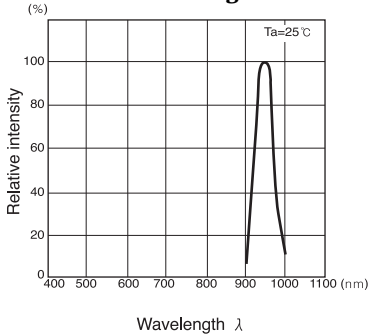

Forward current vs. Forward voltage

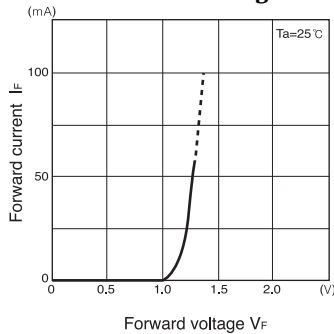

Radiant Pattern

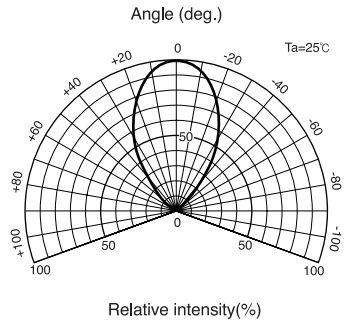

Relative radiant intensity Vs. Distance

