

# Reflective Object Sensors

## Types OPB707A, OPB707B, OPB707C

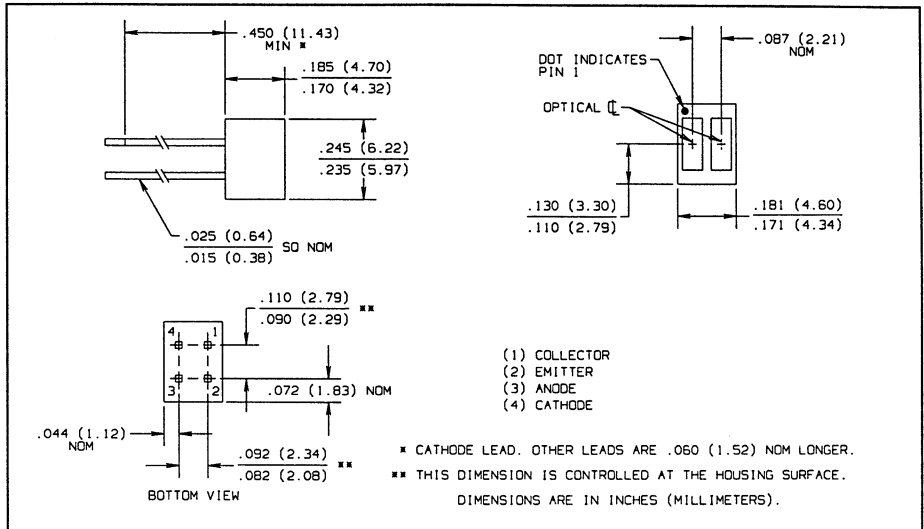
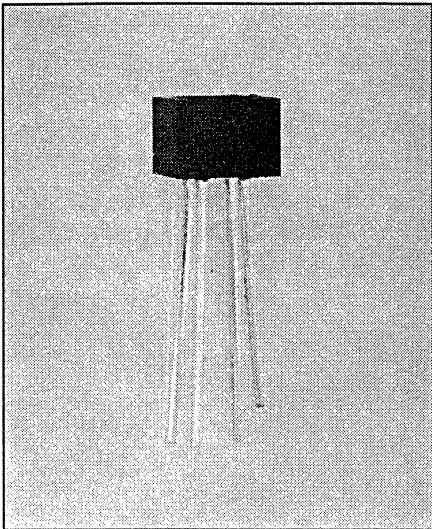

### Features

- Photodarlington output
- Unfocused for sensing diffuse surface
- Low cost plastic housing

### Description

The OPB707 consists of an infrared emitting diode and an NPN silicon photodarlington mounted "side-by-side" on parallel axes in a black plastic housing. Both the emitting diode and photodarlington are molded out of black infrared transmissive plastic to reduce ambient light noise. The photodarlington responds to radiation from the emitter only when a reflective object passes within its field of view.

### Absolute Maximum Ratings ( $T_A = 25^\circ\text{C}$ unless otherwise noted)

Storage and Operating Temperature . . . . .  $-40^\circ\text{C}$  to  $+85^\circ\text{C}$   
 Lead Soldering Temperature [1/16 inch (1.6 mm) from case for 5 sec. with soldering iron] . . . . .  $240^\circ\text{C}^{(1)}$

### Input Diode

Forward DC Current . . . . . 50 mA  
 Peak Forward Current (1  $\mu\text{s}$  pulse width, 300 pps) . . . . . 3.0 A  
 Reverse DC Voltage . . . . . 2.0 V  
 Power Dissipation . . . . .  $75\text{mW}^{(2)}$

### Output Photodarlington

Collector-Emitter Voltage . . . . . 15.0 V  
 Emitter-Collector Voltage . . . . . 5.0 V  
 Collector DC Current . . . . . 125 mA  
 Power Dissipation . . . . .  $100\text{mW}^{(3)}$

### Notes:

- (1) RMA flux is recommended. Duration can be extended to 10 sec. max when flow soldering.
- (2) Derate linearly  $1.25\text{mW}/^\circ\text{C}$  above  $25^\circ\text{C}$ .
- (3) Derate linearly  $1.67\text{mW}/^\circ\text{C}$  above  $25^\circ\text{C}$ .
- (4) d is the distance from the assembly face to the reflective surface.
- (5) Measured using Eastman Kodak neutral white test card with 90% diffuse reflectance as a reflecting surface. Reference: Eastman Kodak, Catalog #1257795.
- (6) Crosstalk ( $I_{cx}$ ) is the collector current measured with the indicated current in the input diode and with no reflecting surface.
- (7) Lower curve is based on a calculated worst case condition rather than the conventional  $-2\sigma$  limit.
- (8) All parameters tested using pulse technique.

# Types OPB707A, OPB707B, OPB707C

Electrical Characteristics ( $T_A = 25^\circ\text{C}$  unless otherwise noted)

REFLECTIVE OBJECT SENSORS

SYMBOL	PARAMETER	MIN	MAX	UNITS	TEST CONDITIONS
<b>Input Diode</b>					
$V_F$	Forward Voltage		1.70	V	$I_F = 20\text{ mA}$
$I_R$	Reverse Current		100	$\mu\text{A}$	$V_R = 2.0\text{ V}$
<b>Output Photodarlington</b>					
$V_{(BR)CEO}$	Collector-Emitter Breakdown Voltage	15		V	$I_C = 100\ \mu\text{A}$
$V_{(BR)ECO}$	Emitter-Collector Breakdown Voltage	5.0		V	$I_E = 100\ \mu\text{A}$
$I_{CEO}$	Collector Dark Current		250	nA	$V_{CE} = 5\text{ V}, I_F = 0, E_e \leq 0.1\ \mu\text{W}/\text{cm}^2$
<b>Combined</b>					
$I_{C(ON)}$	On-State Collector Current	OPB707A OPB707B OPB707C	25 17 10	mA mA mA	$V_{CE} = 5\text{ V}, I_F = 20\text{ mA}, d = 0.050\text{ in. (1.27 mm)}$ <sup>(4)(5)</sup>
$I_{CX}$	Crosstalk		10	$\mu\text{A}$	$V_{CE} = 5\text{ V}, I_F = 20\text{ mA}$ <sup>(6)</sup>
$V_{CE(SAT)}$	Collector-Emitter Saturation Voltage		1.10	V	$I_F = 20\text{ mA}, I_C = 2\text{ mA}, d = 0.050\text{ in. (1.27 mm)}$ <sup>(4)(5)</sup>

## Typical Performance Curves

**Collector Current vs. Diode Forward Current**

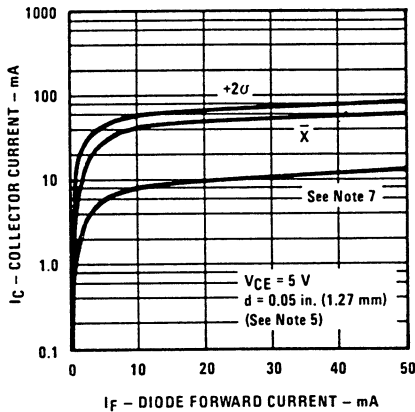

**Normalized Collector Current vs. Ambient Temperature**

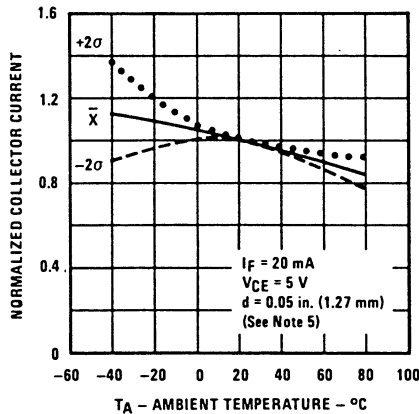

**Normalized Collector Current vs. Object Distance**

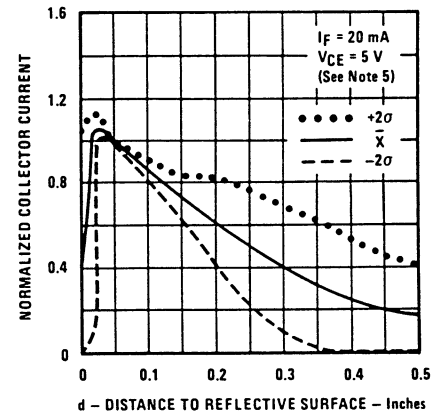

**Rise and Fall Time vs. Load Resistance**

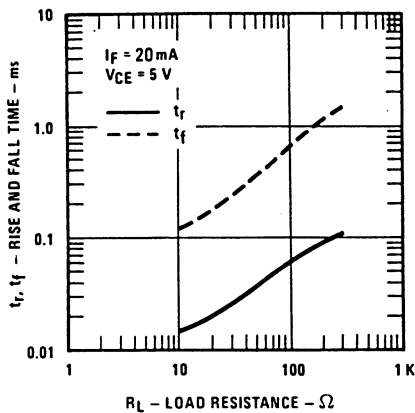

**Test Condition**

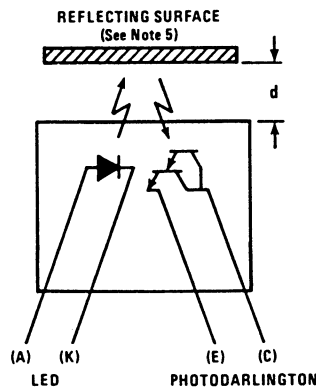

Optek reserves the right to make changes at any time in order to improve design and to supply the best product possible.

Optek Technology, Inc. 1215 W. Crosby Road, Carrollton, Texas 75006 (972) 323-2200 Fax (972) 323-2396  
 SUNSTAR传感与控制 <http://www.sensor-ic.com/> TEL: 0755-83376489 FAX: 0755-83376182 E-MAIL: szss20@163.com